

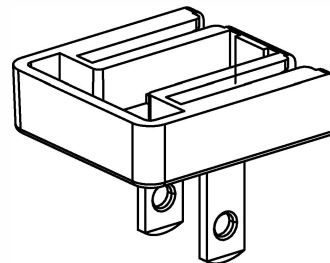

UL AC Plug Dimension(unit:mm)

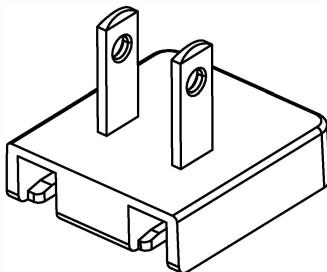
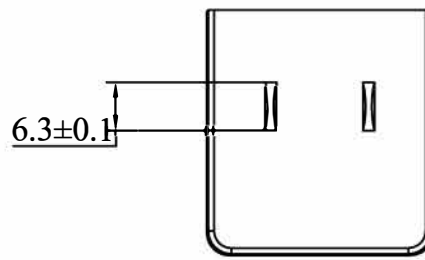
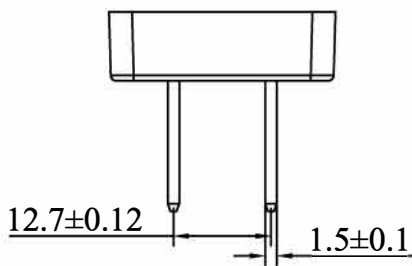
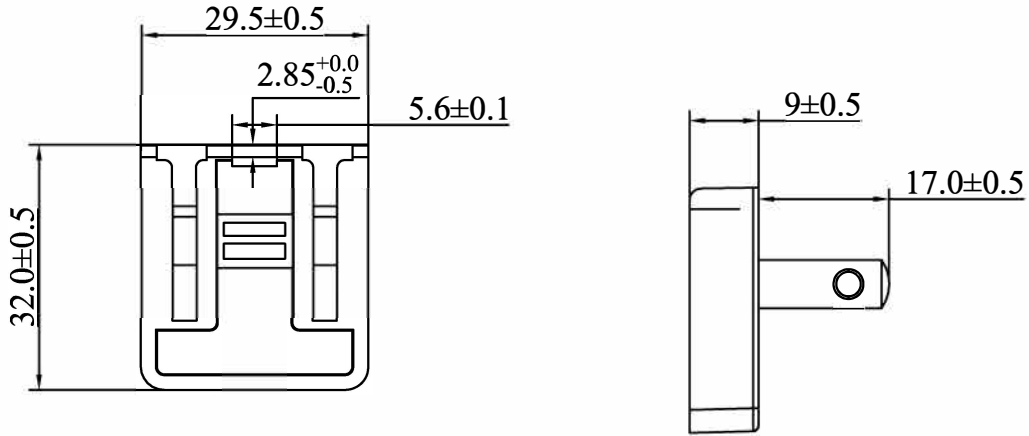

LCP-UL-A Plug Black RoHS+RAHS

300301032000(20100421)

Part No.: KT1001US



Package Method(unit:mm)

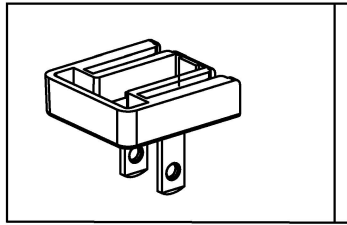

PE bag

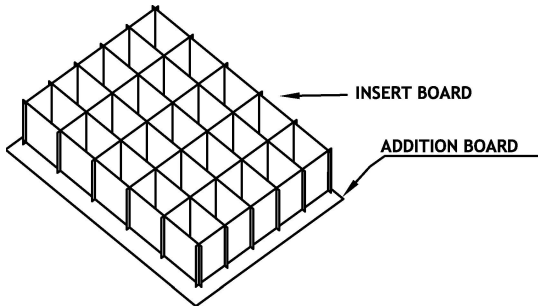

INSERT BOARD

ADDITION BOARD

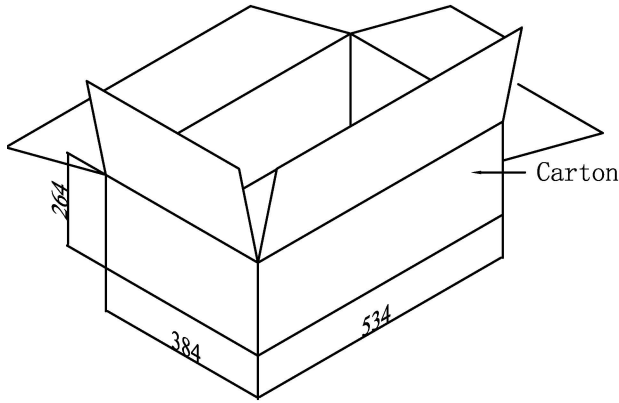

Carton

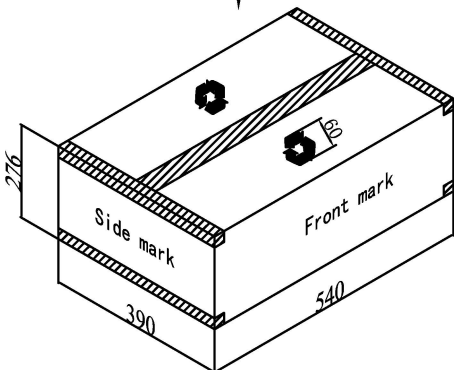

Technical Requirement:

1. Carton: 2 layers wall, 6mm thickness.
Outline dimension: 540mm × 390mm × 276mm
2. Additional board:
3 mm thickness
3 pieces per carton.
3. Humidity protector:
Each plug packed in a small PE bag.
All boxes packed in a big PE bag with an outer carton.
4. Quantity:
2 layers per carton.
200 pcs. per layer.
400 pcs. per carton.
5. Weight:
Each carton approx. 5.6 kg gross.
Each carton approx. 3.4 kg net.

Side mark

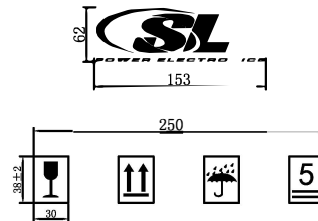

Carton label position

Front mark



MODEL No: _____ DATE CODE: _____
 DESCRIPTION: _____ S/N: _____ TO _____
 ORDER No: _____ QTY: _____
 VOLUME: 54.0x39.0x27.6(CM) WEIGHT: _____

SL Power Electronics Co.,Ltd

1. Words: SL Electronics Co.,Ltd. is Arial, 20mm high
Other words is Arial, 13mm high
2. Color: Recycle logo 60mm high, center position;
words & logo is black.