

ADH1300-48S28 SERIES

1300 W 1/2 Brick Converter



PRODUCT DESCRIPTION

Advanced Energy's ADH1300-48S28 series is a single output digital control DC/DC converter with standard half-brick outline and pin configuration, as well as PMBus™ option. It delivers up to 46.5A output current with 28V output. Ultra high peak efficiency of 95.5% and excellent thermal performance make it an ideal choice to supply power to a power amplifier in telecom and datacom. The baseplate structure makes it possible for the module to work under -40°C to 85°C without air cooling and baseplate operating temperature up to 100°C. A PMBus™ interface is also provided for flexible digital control and monitoring.

SPECIAL FEATURES

- Delivers up to 1300W
- Ultra-high efficiency 95.5% peak
- Wide input range: 36 to 75Vdc
- PMBus™ function
- Excellent thermal performance
- Power good function
- No minimum load requirement
- Fixed switching frequency
- Base-plate for contact cooling
- RoHS 3.0
- Remote control function (negative logic)
- Remote output sense
- Input under voltage lockout
- Input over voltage lockout
- Output over current protection
- Output over voltage protection

- Over temperature protection
- Pin length option: 3.8mm
- 2 years warranty

SAFETY

- IEC/EN/UL/CSA 62368-1
- UL/TUV
- UL94, V-0
- CE Mark

TYPICAL APPLICATIONS

- Datacom
- Telecom

AT A GLANCE

Total Power

1300 W

Input Voltage

36 to 75 Vdc

of Outputs

Single



TABLE OF CONTENTS

Section 1	Model Number	4
Section 2	Electrical Specifications	5
2.1	Absolute Maximum Ratings	5
2.2	Input Specification	6
2.3	Output Specification	7
2.4	PMBus™ Signal Interface Characteristics	9
2.5	Measurement System Characteristics	9
2.6	Performance Curve	10
Section 3	Mechanical Specifications	12
3.1	Mechanical Outlines	12
3.2	Pin Definitions	13
3.3	Pin Size	13
3.4	Mechanical Table	13
Section 4	Environmental Specifications	14
4.1	EMC Immunity	14
4.2	EMC Test Conditions	15
4.3	Safety Certifications	16
4.4	Operating Temperature	17
4.5	Thermal Considerations – Base Plate Module	17
4.6	Qualification Testing	18
Section 5	Application Notes	18
5.1	Typical Application	19
5.2	Remote ON/OFF	20
5.3	Remote Sense	20
5.4	Trim Characteristics	21
5.5	Input Ripple/ Inrush Current/Output Ripple & Noise Test Configuration	22

TABLE OF CONTENTS

Section 6	Soldering Information	23
6.1	Soldering	23
Section 7	PMBUS™ Specification	24
7.1	PMBus™ General Instructions	24
7.2	PMBus™ Addressing	25
7.3	Reading the Status of the Module using the PMBus™	29
7.4	Summary of Supported PMBus™ Commands	32
7.5	AD1300-48S28 series Supported PMBus™ Command list	39
Section 8	Record of Revision and Changes	41

SECTION 1 MODEL NUMBERS

Standard	Output Voltage	Structure	Remote ON/OFF logic	RoHS Status	PMBus™
ADH1300-48S28B-6LI	28Vdc	Baseplate	Negative	RoHS3.0	Yes
ADH1300-48S28PB-6LI	28Vdc	Baseplate	Positive	RoHS3.0	Yes

Order Information

ADH1300	-	48	S	28	P	B	-	6	L	I
①		②	③	④	⑤	⑥		⑦	⑧	⑨

①	Model series	ADH: high efficiency half brick series, 1300: output power 1300W
②	Input voltage	48: 36V to 75V input range, rated input voltage 48V
③	Output number	S: single output
④	Rated output voltage	28: 28V output
⑤	Remote ON/OFF logic	Default: negative logic; P: positive logic
⑥	Baseplate	B: with baseplate; Default: open-frame
⑦	Pin length	Default (no character) for 5.8mm±0.5mm 4: 4.80mm±0.5mm 6: 3.80mm±0.5mm 8: 2.80mm±0.5mm
⑧	RoHS status	Y: RoHS, R5 L: RoHS 3.0
⑨	PMBus™ interface Option	I: With PMBus; Default (no character): No PMBus

Options

None

SECTION 2 ELECTRICAL SPECIFICATIONS

2.1 Absolute Maximum Ratings

Stress in excess of those listed in the “Absolute Maximum Ratings” may cause permanent damage to the power supply. These are stress ratings only and functional operation of the unit is not implied at these or any other conditions above those given in the operational sections of this TRN. Exposure to any absolute maximum rated condition for extended periods may adversely affect the power supply’s reliability.

Table 1. Absolute Maximum Ratings						
Parameter	Model	Symbol	Min	Typ	Max	Unit
Input Voltage	Operating-Continuous	$V_{IN,DC}$	-	-	80	Vdc
	Non-operating -100mS		-	-	100	Vdc
Maximum Output Power	All modules	$P_{O,max}$	-	-	1300	W
Isolation Voltage ¹	All modules		1500	-	-	Vdc
Input to Output						
Operating Temperature	All modules	T_A	-40	-	+85	°C
Storage Temperature	All modules	T_{STG}	-55	-	125	°C
Voltage at remote ON/OFF pin	All models		-0.3	-	18	Vdc
Logic pin voltage (to SIG_GND or Vo-), such as ADDR , CLK, DATA, SMBALERT	All models		-0.3	-	3.6	Vdc
Humidity (non-condensing)	Operating Storage	All modules All modules	10	-	95	%
			10	-	95	%

Note 1 – Test condition is under 1mA for 60s slew rate of 500V/1s

SECTION 2 ELECTRICAL SPECIFICATIONS

2.2 Input Specifications

Table 2. Input Specifications						
Parameter	Condition ¹	Symbol	Min	Typ	Max	Unit
Operating Input Voltage, DC	All	$V_{IN,DC}$	36	48	75	Vdc
Turn-on Voltage Threshold	All	$V_{IN,ON}$	32	34	36	Vdc
Turn-off Voltage Threshold	All	$V_{IN,OFF}$	30	32	34	Vdc
Lockout Voltage Hysteresis	All		1	-	4	Vdc
Maximum Input Current ($I_O = I_{O,max}$)	$V_{IN,DC} = 36Vdc$	$I_{IN,max}$	-	-	40.5	A
No Load Input Current	All	I_{IN,no_load}	-	0.3	-	A
Standby Input Current	Remote OFF		-	0.01	0.1	A
Recommended Input Fuse	Fast blow external fuse recommended		-	-	50	A
Recommended External Input Capacitance	Low ESR capacitor recommended	C_{IN}	470	-	-	μF
Input Reflected Ripple Current(RMS) ²	Through 12 μH inductor		-	32	-	mA_{PK-PK}
Operating Efficiency ³	$T_{BP} = 25^{\circ}C,$ $I_O = I_{O,max}$ $I_O = 50\% I_{O,max}$	η	-	95	-	%
			-	95.5	-	%

Note 1 - $T_a = 25^{\circ}C$, airflow rate at least is 15m/s if there is no large enough heatsink, $V_{in} = 48Vdc$, nominal V_{out} unless otherwise indicated.

Note 2 - Input Reflected Ripple Current(RMS), tested with the circuit as Figure 1.

Note 3 - Refer to figure 9.

SECTION 2 ELECTRICAL SPECIFICATIONS

2.3 Output Specifications

Table 3. Output Specifications							
Parameter	Condition ¹	Symbol	Min	Typ	Max	Unit	
Factory Set Voltage	$T_{BP} = 25^{\circ}\text{C}$, $V_{IN,DC} = 48\text{Vdc}$ $I_O = 0\text{A}$	$V_{O,factory}$	27.44	28	28.56	Vdc	
Output Voltage Line Regulation	$V_{IN,DC} = 35 \text{ to } 75\text{Vdc}$	V_O	-	50	-	mV	
Output Voltage Load Regulation ($I_O = 0\text{A}$ to $I_{O,max}$)	$V_{IN,DC} = 48\text{Vdc}$	V_O	-	20	-	mV	
Output Voltage Temperature Regulation	All	$\%V_O$	-	-	0.02	$\%/^{\circ}\text{C}$	
Output Voltage Trim Range	Rating Input@ Output		-50	-	17.8	%	
Output Ripple, pk-pk ²	20MHz bandwidth	$V_{O,ripple}$	-	100	500	mV_{PK-PK}	
Output Current	All	$I_{O,peak}$	0	-	46.5	A	
Output DC current-limit inception ³			49	-	65	A	
Vo Load Capacitance ⁴	All	C_O	1500	-	5000	μF	
Dynamic Response	25% $I_{O,nom}$ step from 50% $I_{O,nom}$, 0.1A/ μS	$\pm V_O$ T_s	- -	350 250	- -	mV μS	
	100% to 115%(0.25ms) slew rate = 0.1A/ μs ,1kHz	$\pm V_O$ T_s	- -	- -	- -	mV μS	
Turn-on Transient	Rise time	$I_O = I_{O,max}$	$T_{turn-on}$	-	-	300	mS
	Turn-on delay	By DC input				1000	
	Turn-on delay	By Enable	T_{rise}	-	-	1000	mS
	Turn-On overshoot	All	$\%V_O$	-	-	600	%
Switching Frequency	All	fsw	-	300	-	KHz	
Output Over-voltage Protection ⁵	All	V_O	35	-	40	Vdc	
Output Over-temperature Protection ⁶	Baseplate	T	-	110	-	$^{\circ}\text{C}$	

Note 1 - $T_a = 25^{\circ}\text{C}$, airflow rate is at least 15m/s if there is no large enough heatsink, $V_{in} = 48\text{Vdc}$, nominal V_{out} unless otherwise noted.

Note 2 - Tested with the circuit of Figure 2.

Note 3 - Hiccup: auto-restart when the over-current condition is removed. The OCP point drops to about 40A, when V_{in} is more than about 67V and the temperature reported by PMbus command (0x8D) is more than about 95°C , and resumes when the input voltage is less than about 65V or the temperature reported by PMbus command (0x8D) is less than about 95°C .

Note 4 - The maximal capacitance is 5000 μF Al electrolytic.

Note 5 - Hiccup: auto-restart when the over-voltage condition is removed, output voltage regulation via PMbus command(0x21).

Note 6 - Auto recovery. The OTP point drops by about 5°C , when V_{in} is more than about 67V, and resumes when the input voltage is less than about 65V.

SECTION 2 ELECTRICAL SPECIFICATIONS

2.3 Output Specifications

Table 3. Output Specifications						
Parameter	Condition	Symbol	Min	Typ	Max	Unit
Prebias ¹	Ratig Vout $I_o = 0A$	T	0	-	80	%Vo
Output Voltage Remove Sense Range	All	V _o	-	-	+0.5	Vdc
	All	V _o	-	-	-0.5	Vdc
Switching Frequency	All	f _{sw}	-	300	-	kHz
MTBF	Telcordia,SR332,Issue2, Method 1 Case3		-	1.5	-	10 ⁶ Hrs

Note 1 - The pre-bias voltage does not exceed 80% of the normal output voltage.

SECTION 2 ELECTRICAL SPECIFICATIONS

2.4 PMBus™ Signal Interface Characteristics

Table 4. PMBus™ Signal Interface Characteristics					
Parameter	Conditions	Min	Typ	Max	Unit
Input High Voltage (Clock, Data)		2.1	-	3.6	V
Input Low Voltage (Clock, Data)		0	-	0.8	V
Input High Level Current (Clock, Data)		-10	-	10	uA
Output Low Voltage (SMBAlert)	$I_o = 2\text{mA}$	0	-	0.8	V
Output high level open drain leakage current(SMBAlert)	$V_o=3.6\text{V}$	0	-	10	uA
PMBus Operation Frequency		100 or 400			kHz

2.5 Measurement System Characteristics

Table 5. Measurement System Characteristics					
Parameter	Conditions	Min	Typ	Max	Unit
Output Current Reading Accuracy ¹	$0\text{A} < I_o < 46.5\text{A}$	-3	-	3	A
Output Current Reading Resolution ¹		-	0.25	-	A
Output Voltage Reading Accuracy		-3	1	3	$V_{o\text{normal}}\%$
Output Voltage Reading Resolution		-	0.25	-	V
Input Voltage Reading Accuracy ¹		-3	-	3	%
Input Voltage Reading Resolution		-	0.125	-	V
Temperature Reading Accuracy	Ambient temperature above 0°C	-5	3	+5	°C
Temperature Reading Resolution	Ambient temperature above 0°C	-	1	-	°C

Note 1 - Current accuracy and resolution at typical output voltage nominal when the temperature above 0°C. Input voltage accuracy and resolution when the temperature is above 0°C.

SECTION 2 ELECTRICAL SPECIFICATIONS

2.6 Performance Curves

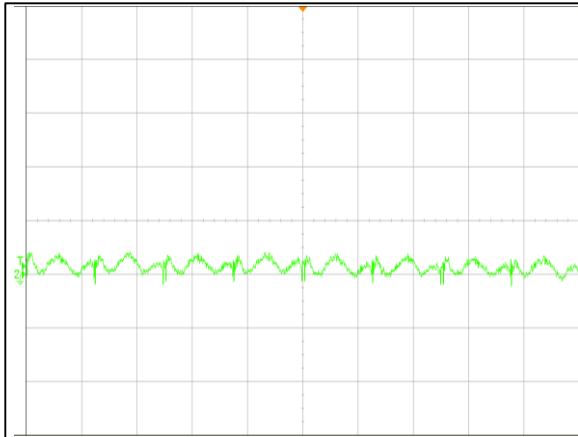

Figure 1: ADH1300-48S28B Input Reflected Ripple Current
 Vin = 48Vdc Load: Io = 46.5A
 Ch 2: Iin (5uS/div, 50mV/div)

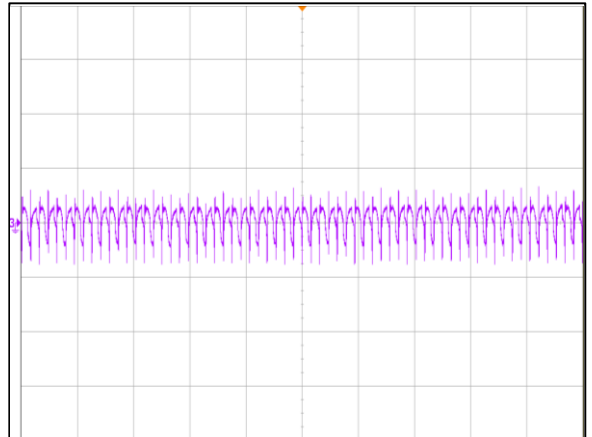

Figure 2: ADH1300-48S28B Ripple and Noise Measurement
 Vin = 48Vdc Load: Io = 46.5A
 Ch 3: Vo (20us/div, 100mV/div)

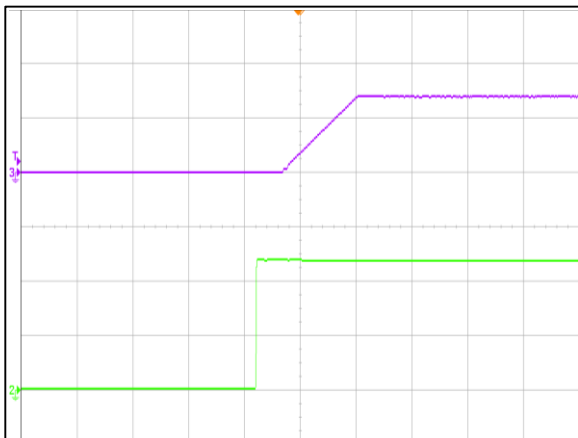

Figure 3: ADH1300-48S28B Output Voltage Startup Characteristic
 Vin = 48Vdc Load: Io = 46.5A (100mS/div)
 Ch 2: Vi (20V/div) Ch 3: Vo (20V/div)

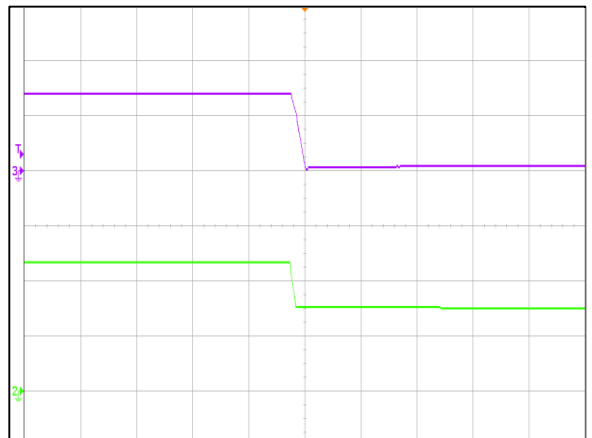

Figure 4: ADH1300-48S28B Turn Off Characteristic
 Vin = 48Vdc Load: Io = 46.5A
 Ch 2: Vi (20V/div) Ch 3: Vo (20V/div)

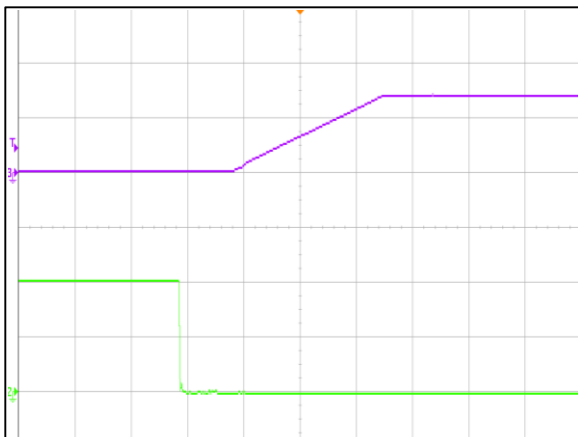

Figure 5: ADH1300-48S28B Remote ON Waveform
 Vin = 48Vdc Load: Io = 46.5A (50mS/div)
 Ch 2: Remote ON (2V/div) Ch 3: Vo (20V/div)

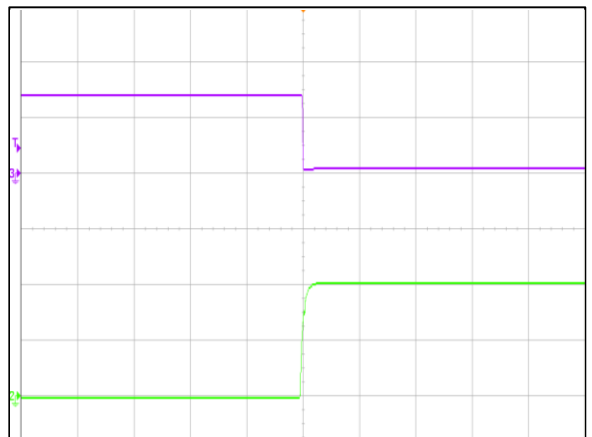

Figure 6: ADH1300-48S28B Transient Response (2mS/div)
 Vin = 48Vdc Load: Io = 46.5A (50mS/div)
 Ch 2: Remote OFF (2V/div) Ch 3: Vo (20V/div)

SECTION 2 ELECTRICAL SPECIFICATIONS

2.6 Performance Curves

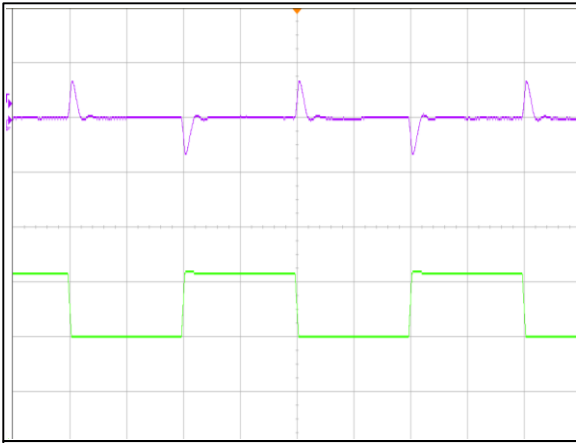

Figure 7: ADH1300-48S28B Transient Response (2mS/div)
 Vin = 48Vdc Io = 50%-75%-50% load change, 0.1A/uS slew rate
 Ch 2: Io (10A/div) Ch 3: Vo (500mV/div)

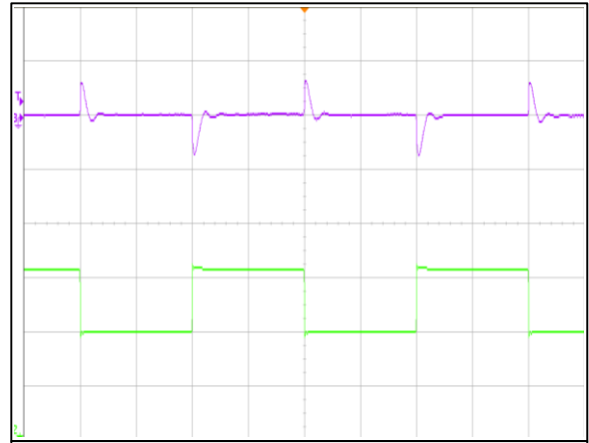

Figure 8: ADH1300-48S28B Transient Response (2mS/div)
 Vin = 48Vdc Io = 25%-50%-25% load change, 0.1A/uS slew rate
 Ch 2: Io (10A/div) Ch 3: Vo (500mV/div)

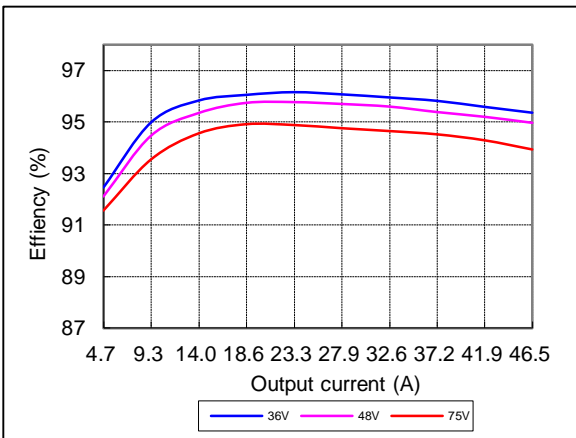

Figure 9: ADH1300-48S28B Efficiency Curves
 Vin = 36 to 75Vdc Loading: Io = 5A to 46.5A

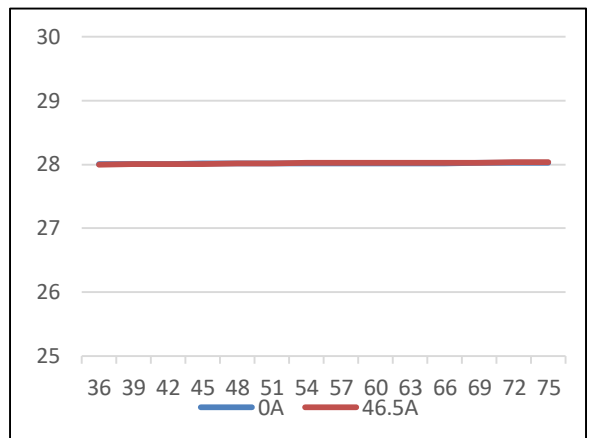
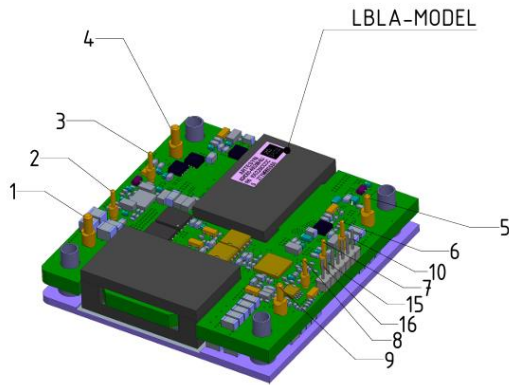

Figure 10: ADH1300-48S28B Output voltage vs. input voltage and load current at T = +25°C

SECTION 3 MECHANICAL SPECIFICATIONS

3.1 Mechanical Outlines (unit: mm)



Laser printing the TLA on top surface of baseplate
Text height 1.8mm ref.

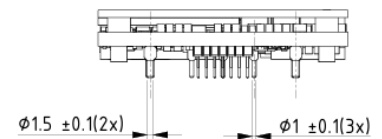
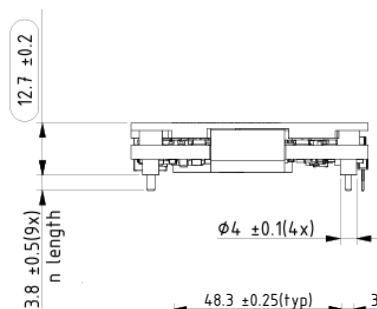
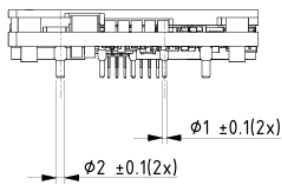
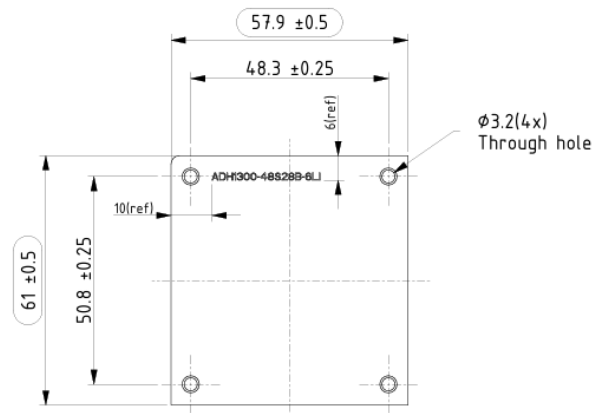
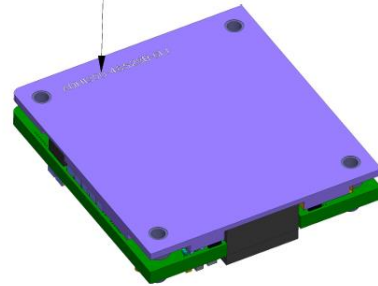

Pin length definition table of ADH1300-48S28B-XLI
The "X" is pin length code for the TLA.

Code X	Pin length	Remark
4	4.8±0.5mm	
6	3.8±0.5mm	
8	2.8±0.5mm	
None	5.8±0.5mm	

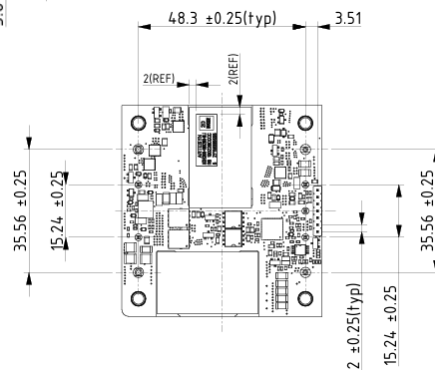

SECTION 3 MECHANICAL SPECIFICATIONS

3.2 Pin Definitions

Pin No	Name	Function
1	Vin+	Positive input voltage
2	CNT	Remote ON/OFF control
3	NC	NC
4	Vin-	Negative input voltage
5	Vo-	Negative output voltage
6	S-	Negative output sense
7	Trim	Output voltage trim
8	S+	Positive output sense
9	Vo+	Positive output voltage
10	Ctrl/PG	PMBus Remote control/Power Good
11	GND	PMBus Ground
12	SDA	PMBus Data
13	SALERT	PMBus alert signal
14	SCL	PMBus Clock
15	SA1	PMBus Address 1
16	SA0	PMBus Address 0

3.3 Pin Size

Device Code Suffix	Pin Size
-4	4.8mm±0.5mm
-6	3.8mm±0.5mm
-8	2.8mm±0.5mm
None	5.8mm±0.5mm

3.4 Mechanical Data

Dimensions (L x W x D)	61.0 x 57.9 x 12.7 mm (2.4 x 2.28 x 0.5 inch)
Weight	128g

SECTION 4 ENVIRONMENTAL SPECIFICATIONS

4.1 EMC Immunity

ADH1300-48S28 series power supply is designed to meet the following EMC immunity specifications.

Table 6. EMC Immunity			
Test Item	Standard	Test Level	Criteria
Conducted Emission	EN55032 DC Input	Class B	B
Electrostatic Discharge	IEC/EN 61000-4-2	Level 3	B
Electrical Fast Transient	IEC/EN 61000-4-4	Level 3	B
Surges	IEC/EN 61000-4-5	Line to Ground (earth): 600V Line to Line: 600V	B
Conducted Disturbances Immunity	IEC/EN 61000-4-6	Level 2	A
Voltage Dips and Short Interruptions and Voltage Variations	EN61000-4-29 DC		B

Criterion A: Normal performance during and after test.

Criterion B: Output voltage fluctuation or reset is allowed during the test, but recovers to its normal performance automatically after the disturbance ceases.

Criterion C: Temporary loss of output, the correction of which requires operator intervention.

Criterion D: Loss of output which is not recoverable, owing to damage of hardware.

SECTION 4 ENVIRONMENTAL SPECIFICATIONS

4.2 EMC Test Conditions

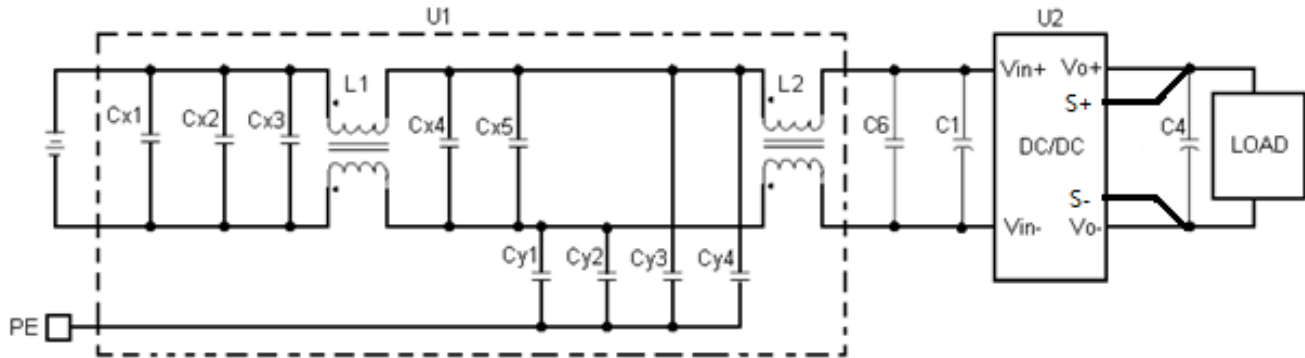

Figure 11 EMC test configuration

U1: Input EMC filter

U2: Module to test, ADH1300-48S28B-6LI

CX1 :4.7uF/100V/X7R capacitor*2, P/N: GRJ31CZ72A475KE01 (muRata) or equivalent caps

CX2,CX3 :4.7uF/100V/X7R capacitor, P/N: GRJ31CZ72A475KE01 (muRata) or equivalent caps

CX4,CX5: 4.7uF/100V/X7S capacitor, P/N: GRJ31CZ72A475KE01 (muRata) or equivalent caps

Cy1, Cy2, Cy3, Cy4: 0.22uF/630V/X7T, Y capacitor, P/N: 631S47W224KV4E(JOHANSON) or equivalent caps

L1, L2: 650uH, common mode inductor, P/N: 801-008235-0000

C6: 100nF/100V/X7R capacitor, P/N: 12101C104JAT2A (AVX) or equivalent caps

C1: 470uF/100V electrolytic capacitor, P/N: UPM2A471MHD (Nichicon) or equivalent caps

C4: 2200uF/50V electrolytic capacitor, P/N: UUD1H222MNL1GS (Nichicon) or equivalent

SECTION 4 ENVIRONMENTAL SPECIFICATIONS

4.3 Safety Certifications

The ADH1300-48S28 series module is intended for inclusion in other equipment and the installer must ensure that it is in compliance with all the requirements of the end application. This product is only for inclusion by professional installers within other equipment and must not be operated as a stand alone product.

Table 7. Safety Certifications for ADH1300-48S28 series module

Standard	Agency	Description
UL/CSA62368	UL+CUL	US and Canada Requirements
EN62368	TUV	European Requirements
IEC62368	CB	International Requirements
CE		CE Marking
UL94		flammability rating
TUV, V-0		International Requirements

SECTION 4 ENVIRONMENTAL SPECIFICATIONS

4.4 Operating Temperature

The ADH1300-48S28 series module will start and operate within stated specifications at an ambient temperature from -40°C to 85°C under all load conditions. The storage temperature is -55°C to 125°C.

4.5 Thermal Considerations - Base plate module

The converter can operate in a enclosed environment without forced air convection. Cooling of the converter is achieved mainly by conduction from the baseplate to a big enough heatsink. The converter can deliver full output power at 85°C ambient temperature ,provided the baseplate temperature is kept below the max values ,Figure 13 shows the derating output current vs. baseplate temperature. The converter is designed to operate in different thermal environments and sufficient cooling must be provided. Proper cooling can be verified by measuring the temperature at the test points as shown in figure 12. The temperature at this point should not exceed the max values in the table 6.



Figure 12 Temperature test point

Table 6. Recommend temperature limit of the test point	
Test Point	Temperature Limit (°C)
Test point P1	100
Test point P2	123

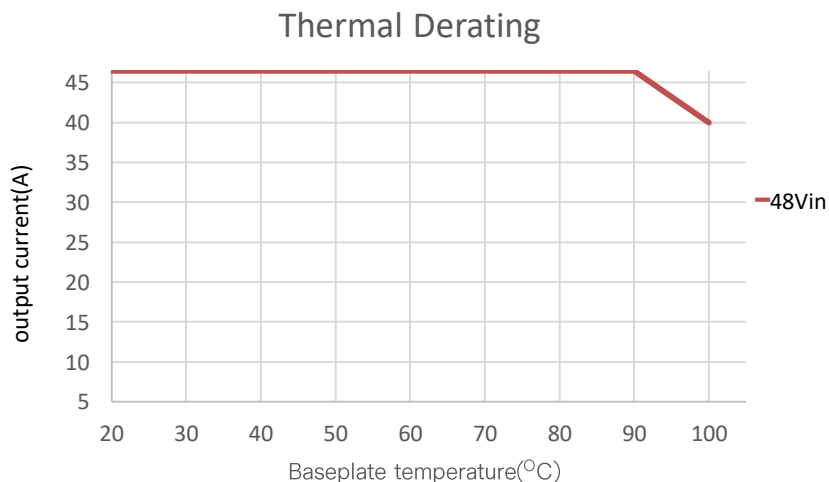

Figure 13 Available load current vs Base plate temperature

SECTION 4 ENVIRONMENTAL SPECIFICATIONS

4.6 Qualification Testing

Parameter	Unit (pcs)	Test condition
HALT test	3 to 4	T _{a,min} -20°C to T _{a,max} +15°C, 5°C step, Vin = min to max, 0 to 100% load
Vibration	3	Frequency range: 5Hz to 20Hz, 20Hz to 200Hz, A.S.D: 1.0m2/s3, -3db/oct, axes of vibration: X/Y/Z. Time: 30min/axes. Non operational
Mechanical Shock	3	Half sine, Acceleration: 30g, 6ms, 3 axes, 6 directions, 3 time/direction. Non operational
Thermal Shock	3	-55°C to 125°C, Temp Dwell Time: 30min, Temp change rate: 20 °C/min, unit temperature 20 cycles. Non operational
Thermal Cycling	3	-40°C to 85°C, temperature change rate: 1°C/min, cycles: 2 cycles
Humidity	3	40°C, 95%RH, 48h
Solder Ability	15	IPC J-STD-002C-2007

SECTION 5 APPLICATION NOTES

5.1 Typical Application

Below is the typical application of the ADH1300-48S28 series power supply.

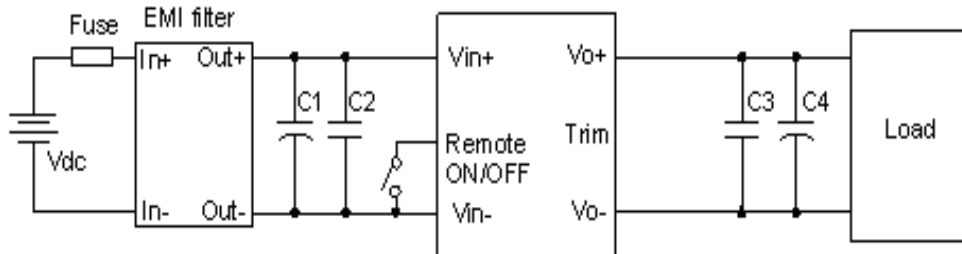

Figure 14 Typical application

C1: 470 μ F/100V electrolytic capacitor, P/N: UPM2A471MED (Nichicon) or equivalent caps

C2: 4.7 μ F/100V X7R ceramic capacitor, P/N: GRJ31CZ72A475KE01L (MURATA) or equivalent caps

C3: 1 μ F/50V X7R ceramic capacitor, P/N: C3216X7R1H106KT0A0E (TDK) or equivalent caps type

C4: 2200 μ F Al electrolytic capacitor, P/N: UPM1H222MHD (Nichicon) or equivalent caps

Fuse: External fast blow fuse with a rating of 50A/250Vac. The recommended fuse model is Walter Electronic, WM55-50

EMI filter: Refer to Figure 11

SECTION 5 APPLICATION NOTES

5.2 Remote ON/OFF

Negative remote ON/OFF logic is available in ADH1300-48S28B-6LI. The logic is CMOS and TTL compatible. Below is the detailed internal circuit and reference in ADH1300-48S28B-6LI.

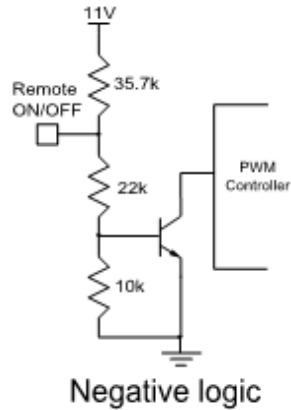

Figure 15 External Remote ON/OFF circuit

5.3 Remote Sense

If the load is far from the unit, connect S+ and S- to the terminal of the load respectively to compensate the voltage drop on the transmission line. See Figure 14. If the sense compensate function is not necessary, connect S+ to Vo+ and S- to Vo- directly.

SECTION 5 APPLICATION NOTES

5.4 Trim Characteristics

To increase or decrease the output voltage set point, connect an external resistor between the TRIM pin and either the Vo+ or Vo-. The TRIM pin should be left open if this feature is not used. Below Trim equation is only adapt to the module without droop current sharing option code; For the module with droop current sharing option code, please contact technical support team. Connecting an external resistor between Trim pin and Vo- pin will decrease the output voltage. While connection it between Trim and Vo+ will increase the output voltage. The following equations determine the external resistance to obtain the trimmed output voltage.

$$R_{adj_down} = \left(\frac{100\%}{\Delta\%} - 2 \right) k\Omega$$

$$R_{adj_up} = \left(\frac{V_{norm}(100\% + \Delta\%)}{1.225 \times \Delta\%} - \frac{100\% + 2 \times \Delta\%}{\Delta\%} \right) k\Omega$$

Δ : Output rate against nominal output voltage.

$$\Delta = \left| \frac{100 \times (V_o - V_{norm})}{V_{norm}} \right|$$

V_{norm} : Nominal output voltage.

For example, to get 33V output, the trimming resistor is

$$R_{adj-up} = \frac{28 \times (100 + 17.86)}{1.225 \times 17.86} - \frac{100\% + 2 \times 17.86\%}{17.86\%}$$

$$= 143.24(K\Omega)$$

The output voltage can also be trimmed by potential applied at the Trim pin.

$$V_o = (V_{trim} + 1.24) \times 11.29$$

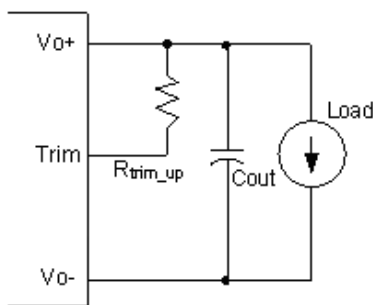

Figure 16 Trim up

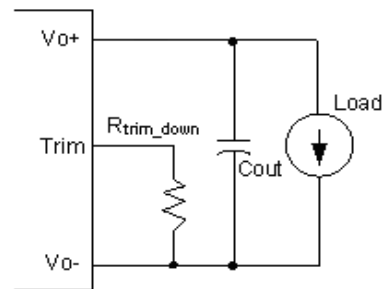

Figure 17 Trim down

Where is the potential applied at the Trim pin, and V_o is the desired output voltage. When trimming up, the output current should be decreased accordingly so as not to exceed the maximum output power.

SECTION 5 APPLICATION NOTES

5.5 Input Ripple & Inrush Current and Output Ripple & Noise Test Configuration

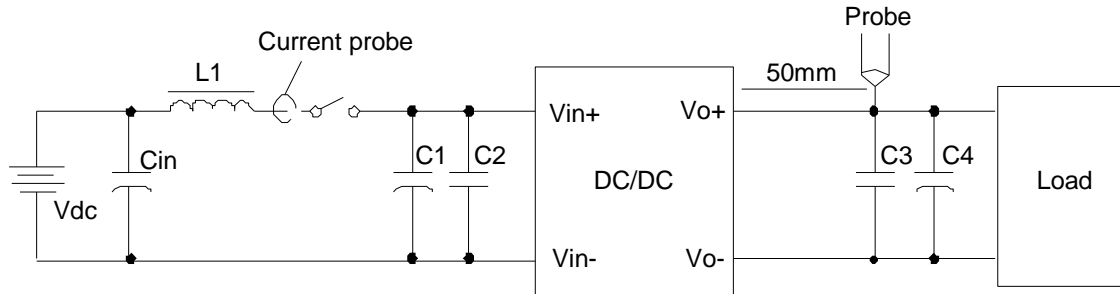

Figure 18 Input ripple & output ripple & noise test configuration

Vdc: DC power supply.

L1: 12uH.

Cin: 470uF/100V typical.

C1: 470uF/100V electrolytic capacitor, P/N: UPM2A471MED (Nichicon) or equivalent caps

C2: 4.7uF/100V X7R ceramic capacitor, P/N: GRJ31CZ72A475KE01L (MURATA) or equivalent caps

C3: 10uF/50V X7R ceramic capacitor, P/N: C3216X7R1H106KT0A0E (TDK) or equivalent caps type

C4: 2200uF Al electrolytic capacitor, P/N: UPM1H222MHD (Nichicon) or equivalent caps

Note - Using a coaxial cable with series 50 Ohm resistor and 0.68 uF ceramic capacitor or a ground ring of probe to test output ripple and noise is recommended.

SECTION 6 SOLDERING INFORMATION

6.1 Soldering

The ADH1300-48S28 series is intended for standard manual or wave soldering.

When wave soldering is used, the temperature on pins is specified to maximum 255°C for maximum 7s.

When soldering by hand, the iron temperature should be maintained at 300°C to 380°C and applied to the converter pins for less than 10s. Longer exposure can cause internal damage to the converter.

Cleaning of solder joint can be performed with cleaning solvent IPA or simulative.

SECTION 7 PMBus™ SPECIFICATIONS

7.1 PMBus™ General Instructions

The ADH1300-48S28B-6LI is equipped with digital PMBus™ interface that allows the module to be configured and to communicate with a system controller. The module supports 3 PMBus signal lines, Data, Clock, Control (C2 pin, optional), and 2 Address line Addr0 and Addr1. Detailed timing and electrical characteristics of the PMBus™ can be found in the PMB Power Management Protocol Specification, Part 1, revision 1.2, available at <http://PMBUS.org>.

The module supports 100/400 kHz bus timing requirements. The module shall stretch the clock, as long as it does not exceed the maximum clock LO period of 35 ms. The module will check the Packet Error Checking scheme (PEC) byte, if provided by the PMBus™ master, and include a PEC byte in all responses to the master. However, the module does not require a PEC byte from the PMBus™ master except command code 0xD9.

The module supports a subset of the commands in the PMBus 1.2 specification. Most all of the controller parameters can be programmed using the PMBus™ and stored as defaults for later use. All commands that require data input or output use the linear format. The exponent of the data words is fixed at a reasonable value for the command and altering the exponent is not supported. Direct format data input or output is not supported by the module. The supported commands are described in greater detail below. The module contains non-volatile memory that is used to store configuration settings and scale factors. The settings programmed into the device are not automatically saved into this non-volatile memory though. The STORE_DEFAULT_ALL command must be used to commit the current settings to non-volatile memory as device defaults. The settings that are capable of being stored in non-volatile memory are noted in their detailed descriptions.

SMBALERT protocol is also supported by the module. SMBALERT line is also a wired-AND signal; by which the module can alert the PMBUS master via pulling the SMBALERT pin to an active low. There are only one way that the master and the module response to the alert of SMBALERT line. This way is for the module used in a system that does not support Alert Response Address (ARA). The module is to retain its resistor programmed address, when it is in an ALERT active condition. The master will communicate with the slave module using the programmed address, and using the various READ_STATUS commands to find who cause for the SMBALERT. The CLEAR_FAULTS command will clear the SMBALERT.

Equipment Setup

The following is a typical I²C communication setup:

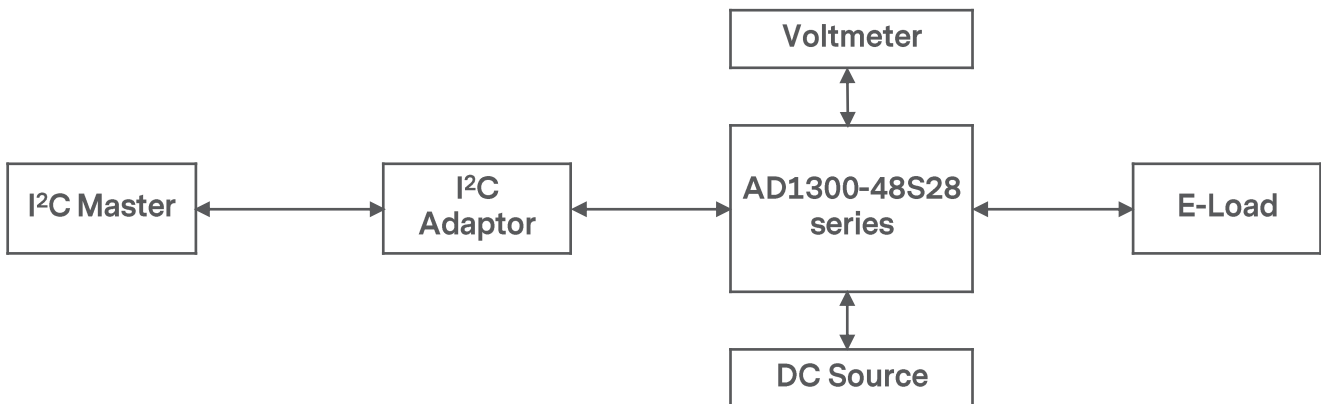

SECTION 7 PMBus™ SPECIFICATIONS

7.2 PMBus™ Addressing

The module has flexible PMBUS addressing capability. When connect different resistor from Addr0 and Addr1 pin to GND pin, 64 possible address can be acquired. The address is in the form of octal digits; Each pin offer one octal digit, and then combine together to form the decimal address as shown in below.

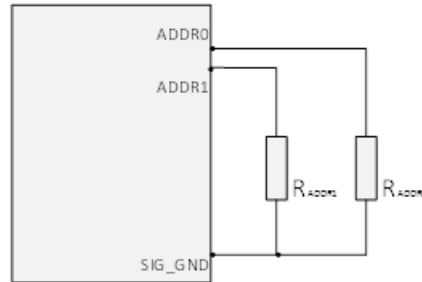

Corresponded to each octal digit, the requested resistor values are shown in below, and 1% tolerance resistors are recommended. If there is any resistance exceeding the request range, address 126 will be return. 0-12,40,44,45,55 in decimal address can't be used, since they are reserved according to the SMBus specifications, and which will also return address 126.

Address = 8 x Addr1 + Addr0, for example when RADDR1=220k, RADDR0=100k, the module address=0x3D.

Digit	Resistor Value (kOhm)
0	10
1	22
2	33
3	47
4	68
5	100
6	150
7	220

SECTION 7 PMBus™ SPECIFICATIONS

PMBus™ Adjustable Input Undervoltage Lockout

The module allows adjustment of the input under voltage lockout and hysteresis. The command VIN_ON allows setting the input voltage turn on threshold, while the VIN_OFF command sets the input voltage turn off threshold. For both the VIN_ON commands, possible values range from 32.000 to 35.000V in 0.125V steps and VIN_OFF values range from 30.000 to 33.000V. VIN_ON must be 1.5V greater than VIN_OFF.

Both the VIN_ON and VIN_OFF commands use the “Linear11” format with two data bytes. The upper five bits [7:3] of the high data byte form the two’s complement representation of the exponent, which is fixed at –3 (decimal). The remaining 11 bits are used for two’s complement representation of the mantissa, with the 11th bit fixed at zero since only positive numbers are valid. The data associated with VIN_ON and VIN_OFF can be stored to non-volatile memory using the STORE_DEFAULT_ALL command. The data associated with VIN_ON and VIN_OFF can be stored to non-volatile memory using the STORE_DEFAULT_ALL command.

Output Voltage Adjustment Using the PMBus™

The module output voltage set point is adjusted using the VOUT_COMMAND. The output voltage setting uses the linear data format, with the 16 bits of the VOUT_COMMAND formatted as an unsigned mantissa, and a fixed exponent of -9 (decimal) (read from VOUT_MODE).

$$VOUT = \text{Mantissa} \times 2^{-9}$$

The resolution is 1.88 mV. The data associated with VOUT_COMMAND can be stored in non-volatile memory using the STORE_DEFAULT_ALL command.

Range limits (max/min): 33/14 V

Notes:

- Trim up @ Vin = 36 to 75 V,
- When trimmed up, the output power not to exceed 1300 W;

Measuring Input Voltage Using the PMBus™

The module can provide input voltage information using the READ_VIN command. The command returns two bytes of data in the linear format. The upper five bits [7:3] of the high data byte form the two’s complement representation of the exponent, which is fixed at -3 (decimal). The remaining 11 bits are used for two’s complement representation of the mantissa, with the 11th bit fixed at zero since only positive numbers are valid.

SECTION 7 PMBus™ SPECIFICATIONS

Measuring Output Voltage Using the PMBus™

The module can provide output voltage information using the READ_VOUT command. The command returns two bytes of data in the linear format, with the 16 bits of the READ_VOUT formatted as an unsigned mantissa, and a fixed exponent of -9 (decimal).

Measuring Output Current Using the PMBus™

The module measures output current by using the output filter inductor winding resistance as a current sense element. The module can provide output current information using the READ_IOUT command. The command returns two bytes of data in the linear format. The upper five bits [7:3] of the high data byte form the two's complement representation of the exponent, which is fixed at -2 (decimal). The remaining 11 bits are used for two's complement representation of the mantissa, with the 11th bit fixed at zero since only positive numbers are valid. The READ_IOUT command provides module average output current information. This command only supports positive current sourced from the module. If the converter is sinking current a reading of 0 is provided.

Measuring the Temperature Using the PMBus™

The module can provide temperature information using the READ_TEMPERATURE_1 command. The command returns two bytes of data in the linear format. The upper five bits [7:3] of the high data byte form the two's complement representation of the exponent, which is fixed at -2 (decimal). The remaining 11 bits are used for two's complement representation of the mantissa.

Note that the module's temperature sensor is located close to the module hot spot OTP test point (see Figure 12) and is subjected to temperatures higher than the ambient air temperature near the module. The temperature and temperature reading will be highly influenced by module load and airflow conditions.

PMBus™ Enabled On/Off

The module can also be turned on and off via the PMBus™ interface. The OPERATION command is used to actually turn the module on and off via the PMBus™, Bit [7] in the OPERATION command data byte enables the module, with the following functions:

- 0: Output is disabled
- 1: Output is enabled

Power Good Function

The module has a power good function, The power good pin has internal weak pull-up function.

When the unit is operating correctly, supplying power and all parameters are within specification, a logic-Low voltage will be present on this pin.

When the unit is not operating correctly – either is under a mode of protection (over temperature, over current, or over-voltage) that is causing the unit to 'shut down' and not supply power, or, if the unit has failed, there will be logic-High voltage present on this pin. The high level can not exceed 3.6V.

At the beginning of 20mS after input voltage is applied to the module, PG maintains high although the output voltage doesn't start up. After this 20mS, the module internal MCU finishes initialization, and the PG indicates output voltage correctly, please refer to the picture below

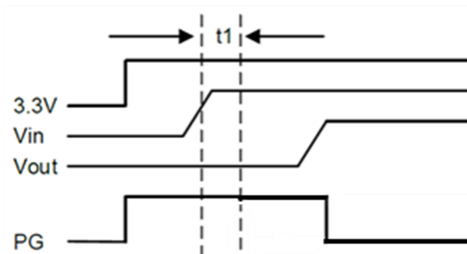

SECTION 7 PMBus™ SPECIFICATIONS

PMBus™ Data Format

The module receives and report date in LINEAR format. The Exponent of the data words is fixed at a reasonable value for the command; altering the exponent is not supported. DIRECT format is not supported by the module.

For commands that set or report any voltage thresholds related to the output voltage, the module supports the linear data format consisting of a two byte value with a 16-bit, unsigned mantissa, and a fixed exponent of -9. The format of the two data bytes is shown below:

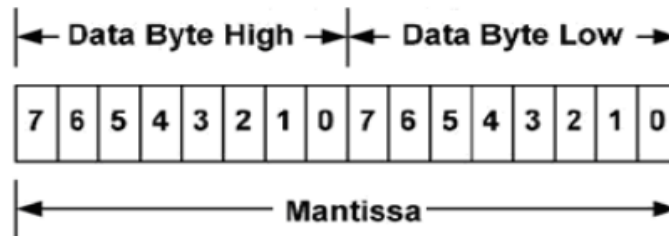

The equation can be written as: $V_{out} = \text{Mantissa} \times 2^{-9}$

For example, considering set V_{out} to 28V by $V_{OUT_COMMAND}$, the read/write data can be calculated refer to below process:

1. Mantissa = $V_{out}/2^{-9} = 28/2^{-9} = 14336$;
2. Converter the calculated Mantissa to hexadecimal 0x3800.

For commands that set or report all other thresholds, including input voltages, output current, temperature, time and frequency, the supported linear data format is a two byte value with: an 11 bit, two's complement mantissa , and a 5 bit, two's complement exponent (scaling factor).The format of the two data bytes is shown as in below.

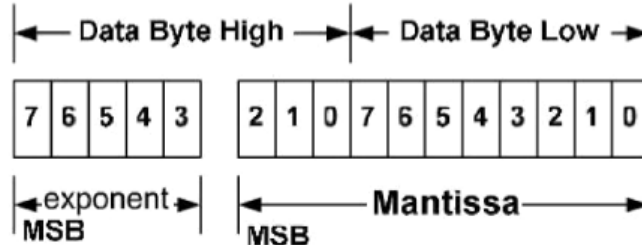

The equation can be written as:

Value = Mantissa x For example, considering set the turn on threshold of input under voltage lockout to 33V by V_{IN_ON} command; the read/write data can be calculated refer to below process:

1. Get the exponent of V_{in} , 0; whose binary is 00000
2. Mantissa = $V_{in}/2^0 = 33/2^0 = 33$;
3. Converter the calculated Mantissa to hexadecimal 21, then converter to binary 00000100001;
4. Combine the exponent and the mantissa, 00000 and 0000000000100001;
5. Converter binary 0000000000100001 to hexadecimal 0021.

The detail exponent and resolution of main parameter is to be decided later.

SECTION 7 PMBus™ SPECIFICATIONS

7.3 Reading the Status of the Module using the PMBus™

The module supports a number of status information commands implemented in PMBus™. However, not all features are supported in these commands. A “X” in the FLAG cell indicates the bit is not supported.

STATUS_WORD: Returns two bytes of information with a summary of the module’s fault/warning conditions.

High Byte

Bit Position	Flag	Default Value
15	VOUT fault	0
14	IOUT fault or warning	0
13	VIN fault	0
12	X	0
11	Power Good (Negative logic)	0
10	X	0
9	X	0
8	X	0

Low Byte

Bit Position	Flag	Default Value
7	X	0
6	OFF	0
5	VOUT Overvoltage	0
4	IOUT Overcurrent	0
3	VIN Undervoltage	0
2	Temperature	0
1	CML (Command)	0
0	X	0

SECTION 7 PMBus™ SPECIFICATIONS

STATUS_VOUT: Returns one byte of information relating to the status of the module's output voltage related faults.

Bit Position	Flag	Default Value
7	VOUT OV Fault	0
6	VOUT OV warning	0
5	X	0
4	X	0
3	X	0
2	X	0
1	X	0
0	X	0

STATUS_IOUT: Returns one byte of information relating to the status of the module's output current related faults.

Bit Position	Flag	Default Value
7	IOUT OC Fault	0
6	X	0
5	IOUT OC Warning	0
4	X	0
3	X	0
2	X	0
1	X	0
0	X	0

STATUS_INPUT: Returns one byte of information relating to the status of the module's input voltage related faults.

Bit Position	Flag	Default Value
7	VIN OV Fault	0
6	VIN OV warning	0
5	VIN UV warning	0
4	VIN UV Fault	0
3	X	0
2	X	0
1	X	0
0	X	0

SECTION 7 PMBus™ SPECIFICATIONS

STATUS_TEMPERATURE: Returns one byte of information relating to the status of the module's temperature related faults.

Bit Position	Flag	Default Value
7	OT Fault	0
6	OT Warning	0
5	X	0
4	X	0
3	X	0
2	X	0
1	X	0
0	X	0

All of the warning or fault bits set in the status registers remain set, even if the fault or warning condition is removed or corrected, until one of the following occur:

- The device receives a CLEAR_FAULTS command
- Bias power is removed from the module

SECTION 7 PMBus™ SPECIFICATIONS

7.4 Summary of Supported PMBus™ Commands

This section outlines the PMBus™ command support for this bus converter. Each supported command is outlined in order of increasing command codes with a quick reference table of all supported commands included at the end of the section. Each command will have the following basic information.

- Command Name [Code]
- Command support
- Additional information may be provided in tabular form or other format, if necessary.

OPERATION [0x01]

Command support: On/Off Immediate

Bit Position	Purpose	Bit Value	Meaning	Default
7	Enable/Disable the module	1	Output is enabled	1
		0	Output is disabled	0
6	Reserved			
5:4	Vout Command	00	No margin	00
		01	Margin low(Act on Fault)	
		10	Margin high(Act on Fault)	
3:0	Reserved			0000

CLEAR_FAULTS [0x03]

Command support: All functionality

STORE_DEFAULT_ALL [0x11]

Command support: All functionality - Stores operating parameters to E²prom memory.

RESTORE_DEFAULT_ALL [0x12]

Command support: All functionality - Restores operating parameters from E²prom memory.

VOUT_MODE [0x20]

Command support: Supported. Factory default: 0x17 - Indicates linear mode with exp = -9.

SECTION 7 PMBus™ SPECIFICATIONS

VOUT_COMMAND [0x21]

Data format: 16 bit unsigned mantissa (implied exponent per VOUT_MODE)

Factory default: 28 V

Range limits (max/min): 33/14V

Unit: volt

Notes:

- Trim up within the input voltage range: $V_{in} = 36$ to 75V.
- When trimming up, ensure the output power does not exceed 1300 W.

VIN_ON [0x35]

Range limits (max/min): 35/32

Unit: volt

Command support: All functionality

Note: Special interlock checks between VIN_ON and VIN_OFF maintain a hysteresis gap of 1.5 V minimum and do not allow the OFF level to be higher than and ON level.

VIN_OFF [0x36]

Range limits (max/min): 33/30

Unit: volt

Command support: All functionality

Note: Special interlock checks between VIN_ON and VIN_OFF maintain a hysteresis gap of 1.5 V minimum and do not allow the OFF level to be higher than and ON level.

VOUT_OV_FAULT_LIMIT [0x40]

Range limits (max/min): 40/35

Units: volt

Command support: All functionality

Note:

1. Range cross-check – value must be greater than VOUT_COMMAND value.

IOUT_OC_FAULT_LIMIT [0x46]

Range limits (max/min): 65/49

Unit: amp

Command support: All functionality

Note: Range cross-check-value must be greater than IOUT_OC_WARN_LIMIT value.

SECTION 7 PMBus™ SPECIFICATIONS

IOUT_OC_WARN_LIMIT [0x4A]

Range limits (max/min): 64/48

Unit: amp

Command support: Read/write support, functionality complete

Note: Range cross-check-value must be the same or less than IOUT_OC_FAULT_LIMIT value.

OT_FAULT_LIMIT [0x4F]

Range limits (max/min): 125/100

Unit: degC

Command support: All functionality

Note: Range cross-check-value must be greater than OT_WARN_LIMIT value.

OT_WARN_LIMIT [0x51]

Range limits (max/min): 125/100

Unit: degC

Command support: All functionality

Note: Range cross-check-value must be less than OT_FAULT_LIMIT value.

VIN_OV_FAULT_LIMIT [0x55]

Range limits (max/min): 80/85

Units: volt

Command support: All functionality

Note: Range cross-check – value must be less than VIN_OV_WARN_LIMIT value.

VIN_OV_WARN_LIMIT [0x57]

Range limits (max/min): 79/84

Units: volt

Command support: All functionality

Note: Range cross-check – value must be less than VIN_OV_FAULT_LIMIT value.

SECTION 7 PMBus™ SPECIFICATIONS

STATUS_WORD [0x79]

High byte

Bit Position	Purpose	Bit Value	Meaning
7	An output over voltage fault or warning	1	Occurred
		0	No Occurred
6	An output over current fault or warning	1	Occurred
		0	No Occurred
5	An input voltage fault, including over voltage and under-voltage	1	Occurred
		0	No Occurred
4	Reserved		
3	Power_Good	1	Is negated
		0	OK
2:0	Reserved		

Low byte

Bit Position	Purpose	Bit Value	Meaning
7	Reserved		
6	OFF (The unit is not providing power to the output, regardless of the reason)	1	Occurred
		0	No Occurred
5	An output over voltage fault	1	Occurred
		0	No Occurred
4	An output over current fault	1	Occurred
		0	No Occurred
3	An input under voltage fault	1	Occurred
		0	No Occurred
2	A temperature fault or warning	1	Occurred
		0	No Occurred
1	CML (A communications, memory or logic fault)	1	Occurred
		0	No Occurred
0	Reserved		

SECTION 7 PMBus™ SPECIFICATIONS

STATUS_VOUT [0x7A]

Command support: VOUT_OV_FAULT and VOUT_OV_WARN supported, all bit reset supported

Format	8 bit unsigned (bit field)							
Bit Position	7	6	5	4	3	2	1	0
Access	R/Reset	R/Reset	R/Reset	R/Reset	R/Reset	R/Reset	R/Reset	R/Reset
Function	VOUT_OV_FAULT	VOUT_OV_WARN	Reserved	Reserved	Reserved	Reserved	Reserved	Reserved

STATUS_IOUT [0x7B]

Command support: IOUT_OC_FAULT and IOUT_OC_WARN supported, all bit reset supported

Format	8 bit unsigned (bit field)							
Bit Position	7	6	5	4	3	2	1	0
Access	R/Reset	R/Reset	R/Reset	R/Reset	R/Reset	R/Reset	R/Reset	R/Reset
Function	IOUT_OC_FAULT	Reserved	IOUT_OC_WARN	Reserved	Reserved	Reserved	Reserved	Reserved

STATUS_INPUT [0x7C]

Command support: VIN_OV_FAULT, VIN_OV_WARN, VIN_UV_WARN and VIN_UV_FAULT supported, all bit reset supported

Format	8 bit unsigned (bit field)							
Bit Position	7	6	5	4	3	2	1	0
Access	R/Reset	R/Reset	R/Reset	R/Reset	R/Reset	R/Reset	R/Reset	R/Reset
Function	VIN_OV_FAULT	VIN_OV_WARN	VIN_UV_WARN	VIN_UV_FAULT	Reserved	Reserved	Reserved	Reserved

STATUS_TEMPERATURE [0x7D]

Command support: OT_WARN, OT_FAULT supported, all bit reset supported

Format	8 bit unsigned (bit field)							
Bit Position	7	6	5	4	3	2	1	0
Access	R/Reset	R/Reset	R/Reset	R/Reset	R/Reset	R/Reset	R/Reset	R/Reset
Function	OT_FAULT	OT_WARN	Reserved	Reserved	Reserved	Reserved	Reserved	Reserved

SECTION 7 PMBus™ SPECIFICATIONS

STATUS_CML [0x7E]

Command support: Invalid/Unsupported Command Received, Invalid/Unsupported Data Received and Packet Error Check Failed supported, all bit reset supported

Format	8 bit unsigned (bit field)							
Bit Position	7	6	5	4	3	2	1	0
Access	R/Reset	R/Reset	R/Reset	R/Reset	R/Reset	R/Reset	R/Reset	R/Reset
Function	Invalid/Un supported Command Received	Invalid/Un supported Data Received	Packet Error Check Failed	Reserve	Reserved	Reserved	Reserved	Reserved

READ_VIN [0x88]

Command support: full support

READ_VOUT [0x8B]

Command support: full support

READ_IOUT [0x8C]

Command support: full support

READ_TEMPERATURE_1 [0x8D]

Command support: full support

PMBus_REVISION [0x98]

Command support: full read support

PMBus_CMD_MFR_ID [0x99]

Command support: full read support

PMBus_CMD_MFR_MODEL [0x9A]

Command support: full read support

MFR_FW_REV [0x9B]

Command support: full read support

PMBus_CMD_MFR_LOCATION [0x9C]

Command support: full read/write support

SECTION 7 PMBus™ SPECIFICATIONS

PMBus_CMD_MFR_SERIAL [0x9E]

Command support: full read/write support

MFR_C1_C2_ARA_CONFIG [0xF7]

Bit Position	Purpose	Bit Value	Meaning
7:5	Reserved	000	Reserved
4	ARA	0	ARA not functional, module remains at resistor programmed address when SMBLAERT is asserted
3:0	PIN Configuration	0000	C2 pin: POWER_GOOD
		0010	C2 pin: POWER_GOOD

MFR_C2_Configure [0xE0]

Bit Position	Purpose	Bit Value	Meaning	Default Value
7:2	Reserved	000000	Reserved	000000
1	ON/OFF Configuration	0	Secondary side on/off pin state when mapped to C2 is ignored	0
		1	AND – Primary and Secondary side on/off	
0	PIN Configuration	0	Negative Logic (Low Enable: Input < 0.8V wrt Vout(-))	1
		1	Positive Logic (High Enable: Input > 2.0V wrt Vout(-))	

MFR_PGOOD_POLARITY [0xE1]

The power good pin 10 indicates when the power unit is ready to provide regulated output voltage to the load. Under the default condition, during a fault state, PG is held high. PG is asserted low after the output has ramped to a voltage above 25V, and de-asserted if the output voltage falls below 17V. The default threshold should be changed as the set value of the output voltage changes. These thresholds may be changed using the PMBus commands POWER_GOOD_ON and POWER_GOOD_OFF. When output voltage is changed, These thresholds should be made reasonable adjustments.

Bit Position	Purpose	Bit Value	Meaning
7:1	Reserved	0000000	Reserved
0	Power Good Logic	0	Negative PGOOD logic
		1	Positive PGOOD logic

SECTION 7 PMBus™ SPECIFICATIONS

7.5 AD1300-48S28 series Supported PMBus™ Command list

Command Code	Command Name	Default Value	Access Type	Data Bytes	Data Format	Description
01h	OPERATION	80h	R/W	1	Bit field	Used to turn the unit ON/OFF
03h	CLEAR_FAULTS	-	Send	1	N/A	Clear any fault bits that have been set
11h	STORE_DEFAULT_ALL	-	Send	0	N/A	Stores operating parameters to E2prom memory
12h	RESTORE_DEFAULT_ALL	-	Send	0	N/A	Restores operating parameters from E2prom memory
20h	VOUT_MODE	17h	R	1	Mode+exp	To read VOUT data format
21h	VOUT_COMMAND	28V	R/W	2	VOUT Linear	Set the output voltage
25h	VOUT_MARGIN_HIGH	33V	R/W	2	VOUT Linear	Set the margin high output voltage
26h	VOUT_MARGIN_LOW	14V	R/W	2	VOUT Linear	Set the margin low output voltage
35h	VIN_ON	35V	R/W	2	Linear11	Set the turn on voltage threshold of vin
36h	VIN_OFF	33V	R/W	2	Linear11	Set the turn off voltage threshold of vin
40h	VOUT_OV_FAULT_LIMIT	36V	R/W	2	VOUT Linear	Set the output overvoltage fault threshold
46h	IOUT_OC_FAULT_LIMIT	60A	R/W	2	Linear11	Set the output overcurrent fault threshold
4Ah	IOUT_OC_WARN_LIMIT	55A	R/W	2	Linear11	Set the output overcurrent warn threshold
4Fh	OT_FAULT_LIMIT	-	R/W	2	Linear11	Set the over temperature fault threshold
51h	OT_WARN_LIMIT	-	R/W	2	Linear11	Set the over temperature warn threshold
55h	VIN_OV_FAULT_LIMIT	83V	R/W	2	Linear11	Set the input overvoltage fault threshold
57h	VIN_OV_WARN_LIMIT	81V	R/W	2	Linear11	Set the input overvoltage warn threshold
5Eh	POWER_GOOD_ON	26V	R/W	2	VOUT Linear	Set the output power good on voltage threshold
5Fh	POWER_GOOD_OFF	13V	R/W	2	VOUT Linear	Set the output power good off voltage threshold
60h	TON_DELAY	-	R/W	2	Linear	Set the power on delay time.
79h	STATUS_WORD	-	R	2	Bit field	Returns the information with a summary of the module's fault/warning
7Ah	STATUS_VOUT	-	R	1	Bit field	Returns the information of the module's output voltage related fault/warning
7Bh	STATUS_IOUT	-	R	1	Bit field	Returns the information of the module's output current related fault/warning
7Ch	STATUS_INPUT	-	R	1	Bit field	Returns the information of the module's input over voltage and under voltage fault
7Dh	STATUS_TEMPERATURE	-	R	1	Bit field	Returns the information of the module's temperature related fault/warning
7Eh	STATUS_CML	-	R	1	Bit field	Returns the information of the module's communication related faults
88h	READ_VIN	-	R	2	Linear11	Returns the input voltage of the module
8Bh	READ_VOUT	-	R	2	VOUT Linear	Returns the output voltage of the module
8Ch	READ_IOUT	-	R	2	Linear11	Returns the output current of the module
8Dh	READ_TEMP1	-	R	2	Linear11	Returns the module's temperature sensor temperature
98h	PMBUS_REVISION	1.2	R	1	Bit field	Read the version of the PMBUS

SECTION 7 PMBus™ SPECIFICATIONS

7.5 AD1300-48S28 series Supported PMBus™ Command list

Command Code	Command Name	Default Value	Access Type	Data Bytes	Data Format	Description
99h	PMBUS_CMD_MFR_ID	Artesyn	R		Char	Returns the manufacturer info
9Ah	PMBUS_CMD_MFR_MODEL	ADH1300-48S28B-6LI	R		Char	Returns the module name info
9Bh	MFR_FW_REV	-	R		Char	Returns the version of the software
9Ch	MFR_MOD_DATE_LOC_SN	ZS	R/W		Char	Returns the production's place of the module
9Eh	PMBUS_CMD_MFR_SERIAL	-	R/W		Char	Returns the serial number of the module
E0h	MFR_C2_Configure	00h	R/W	1	Bit field	Configures the C2 pin on/off function and logic;
E1h	MFR_PGOOD_POLARITY	00h	R/W	1	Bit field	Configure Power Good logic

SECTION 8 RECORD OF REVISION AND CHANGES

Issue	Date	Description	Originators
1.0	06.10.2026	First issue	Z.Yasheng



For international contact information,
visit advancedenergy.com.

powersales@aei.com (Sales Support)
productsupport.ep@aei.com (Technical Support)
+1 888 412 7832

ABOUT ADVANCED ENERGY

Advanced Energy (AE) has devoted more than four decades to perfecting power for its global customers. AE designs and manufactures highly engineered, precision power conversion, measurement and control solutions for mission-critical applications and processes.

Our products enable customer innovation in complex applications for a wide range of industries including semiconductor equipment, industrial, manufacturing, telecommunications, data center computing, and medical. With deep applications know-how and responsive service and support across the globe, we build collaborative partnerships to meet rapid technological developments, propel growth for our customers, and innovate the future of power.

PRECISION | POWER | PERFORMANCE | TRUST

Specifications are subject to change without notice. Not responsible for errors or omissions. ©2026 Advanced Energy Industries, Inc. All rights reserved. Advanced Energy, and AE are U.S. trademarks of Advanced Energy Industries, Inc.