

# ADVANCED ENERGY FCM10K SERIES MODULE

10,000 W AC/DC Power Supply Platform for Bulk Front-end Industrial Applications

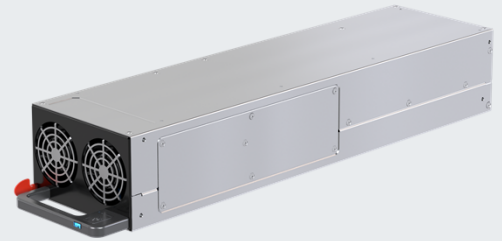

## PRODUCT DESCRIPTION

Advanced Energy's FCM10K series provides for three phase three wire of AC-DC embedded power requirements. Featuring high build quality with robust screw terminals, long life, and typical full-load efficiency of greater than 96.3%, reaching a peak of 97%, these units are ideal for use in industrial applications. They are backed by a comprehensive set of industrial safety approvals and certificates. Variable-speed "smart fans" draw on software controls developed by Advanced Energy to match fan speed to the unit's cooling requirement and load current. Slowing the fan not only saves power but also reduces wear, thus extending its life.

## SPECIAL FEATURES

- 10,000 W output power
- 81.6 mm x 125.85 mm x 460 mm
- -40 to +50°C
- 5 V at 2 A housekeeping
- Peak efficiency: 97% typical
- Supports NFC tag application
- Semi F47 compliance
- Five-year warranty

## SAFETY

- UL 62368-1, 3<sup>rd</sup> Ed
- CAN/CSA C22.2 62368-1, 3<sup>rd</sup> Ed
- EN IEC 62368-1:2020/A11:2020
- IEC 62368-1: 2018 3<sup>rd</sup> Ed
- CB Certificate and Report (IEC 62368-1 3<sup>rd</sup> Ed)
- CE (LVD+RoHS)

## COMPLIANCE

- EMI Class B, with 6 dB margin
- EN61000 Immunity

## AT A GLANCE

### Total Power

10,000 W

### Input Voltage

187 to 528 VAC, 3 Phase 3 Wire + PE

### Nominal Output Voltage

54.5 VDC

### # of Outputs

Single



## TABLE OF CONTENTS

<b>Section 1</b>	<b>Model Numbers</b>	<b>4</b>
<b>Section 2</b>	<b>Electrical Specifications</b>	<b>5</b>
	<b>2.1 Absolute Maximum Ratings</b>	<b>5</b>
	<b>2.2 Input Specifications</b>	<b>6</b>
	<b>2.3 Output Specifications</b>	<b>7</b>
	<b>2.4 System Timing Specifications</b>	<b>8</b>
	<b>2.5 System Timing Diagram</b>	<b>9</b>
	<b>2.6 Performance Curves</b>	<b>10</b>
	<b>2.7 Protection Function Specifications</b>	<b>12</b>
<b>Section 3</b>	<b>Mechanical Specifications</b>	<b>14</b>
	<b>3.1 Mechanical Outlines (-P)</b>	<b>14</b>
	<b>3.2 Mechanical Outlines (-T)</b>	<b>15</b>
	<b>3.3 Connector Definitions (-P)</b>	<b>16</b>
	<b>3.4 Connector Definitions (-T)</b>	<b>18</b>
	<b>3.5 Power/Signal Mating Connectors and Pin Types</b>	<b>20</b>
	<b>3.6 LED Indicator Definition</b>	<b>21</b>
	<b>3.7 Weight</b>	<b>22</b>
<b>Section 4</b>	<b>NFC Tag Specification</b>	<b>23</b>
<b>Section 5</b>	<b>Environmental Specifications</b>	<b>24</b>
	<b>5.1 EMC Immunity</b>	<b>24</b>
	<b>5.2 Safety Certifications</b>	<b>25</b>
	<b>5.3 EMI Emissions</b>	<b>26</b>
	<b>5.4 Operating Temperature</b>	<b>28</b>
	<b>5.5 Forced Air Cooling</b>	<b>28</b>
	<b>5.6 Storage Temperature</b>	<b>29</b>
	<b>5.7 Altitude</b>	<b>29</b>

## TABLE OF CONTENTS

<b>Section 5</b>	<b>Environmental Specifications</b>	<b>24</b>
5.8	Humidity	29
5.9	Vibration	29
5.10	Shock	31
<b>Section 6</b>	<b>Power and Control Signal Descriptions</b>	<b>32</b>
6.1	Input Terminal	32
6.2	Output Terminal (-P)	32
6.3	Output Terminal (-T)	32
6.4	Isolated Signals	33
6.5	Non- Isolated Signals	36
<b>Section 7</b>	<b>Communication BUS Description</b>	<b>37</b>
<b>Section 8</b>	<b>MODBUS Specification</b>	<b>40</b>
8.1	FCM10K Series MODBUS General Instructions	40
8.2	The FCM10K Series Supported Modbus Command List	44
<b>Section 9</b>	<b>Application Notes</b>	<b>54</b>
9.1	Mode of Operation	54
9.2	Digital and Analog Command	54
9.3	Output Adjustability and Programmability	55
9.4	Current Share	64
9.5	Output Ripple and Noise Measurement	65
9.6	Accessories	66
<b>Section 10</b>	<b>Record of Revision and Changes</b>	<b>68</b>

## SECTION 1 MODEL NUMBERS

Standard	Nominal Output Voltage	Trim Range	Max Current	Standby Output	Dimensionon
FCM10KW-N	54.5 VDC	48 to 60 VDC	183.5A	5VDC at 2A	81.6 x 125.85 x 460 mm

Note – Add “-T” for Terminal Block  
 Add “-P” for Pluggable Connector

### Ordering Information

FCM	10K	Y	-	A	-	B
①	②	③		④		⑤

①	Model Series	FCM: Series Name
②	Max Output Power in Watts	10K = 10 kW
③	Voltage Code	W = 54.5 VDC at 183.5A; Programmable Range: 48-60 VDC
④	Module Type	N = Standard (Narrow Range) W = Wide Range H = High Isolation F = Fast Slew Rate
⑤	Interface Type	T = Terminal for Standalone Module P = Pluggable for Module Used in Shelf

## SECTION 2 ELECTRICAL SPECIFICATIONS

### 2.1 Absolute Maximum Ratings

Stress in excess of those listed in the “Absolute Maximum Ratings” may cause permanent damage to the power supply. These are stress ratings only and functional operation of the unit is not implied at these or any other conditions above those given in the operational sections of this TRN. Exposure to any absolute maximum rated condition for extended periods may adversely affect the power supply’s reliability.

Parameter	Model	Symbol	Min	Typ	Max	Unit				
Input Voltage AC continuous operation	All modules	$V_{IN,AC}$	187	208-480	528	VAC				
Maximum Output Power	All modules	$P_{O,max}$	-	-	10000	W				
Isolation Voltage	All modules									
Primary to Protective Earth (PE)							-	-	2500	VDC
Primary to Secondary							-	-	2500	VDC
Primary to User-Accessible							-	-	2500	VDC
Secondary (SELV) to Protective Earth (PE) <sup>1</sup>							-	-	100	VDC
Secondary (NSELV) to Protective Earth (PE) <sup>2</sup>							-	-	2500	VDC
Secondary (SELV) to User-accessible <sup>1</sup>							-	-	500	VDC
Secondary (NSELV) to User-accessible <sup>2</sup>							-	-	2500	VDC
User-accessible to Protective Earth (PE)	-	-	100	VDC						
Ambient Operating Temperature <sup>3</sup>	All modules	$T_A$	-40	-	+70	°C				
Storage Temperature	All modules	$T_{STG}$	-40	-	+85	°C				
Humidity (non-condensing)	All modules									
Operating							20	-	90	%
Non-operating	10	-	95	%						
Altitude	All modules									
Operating							-	-	3000	m
Non-operating	-	-	9144	m						
MTBF <sup>4</sup>	All modules		200	-	-	kHours				

Note 1 - Secondary (SELV) refers to the power supply variant with output voltage 60V and below.

Note 2 - Secondary (NSELV) refers to the power supply variant with output voltage greater than 60V.

Note 3 - -40°C to 50°C at 100% rated load, above 50°C to 70°C, power derated linearly. The power supply shall be able to start at -40°C rated full load.

Note 4 - Using Telcordia specifications at 25°C ambient at full load, nominal line of 480 VAC. With the power supply installed in a system in a 30°C ambient environment and operating at full load, capacitor life shall be 5 years, minimum, for all electrolytic capacitors contained within this power supply. The power supply shall demonstrate an MTBF level of > 500,000 hours based on cumulated DRV testing hours.

## SECTION 2 ELECTRICAL SPECIFICATIONS

## 2.2 Input Specifications

Table 2. Input Specifications						
Parameter	Condition	Symbol	Min	Typ	Max	Unit
Operating Input Voltage, AC	All	$V_{IN,AC}$	187	208	229	VAC
			216	240	264	VAC
			311	346	381	VAC
			342	380	418	VAC
			360	400	480	VAC
			432	480	528	VAC
Input AC Frequency	All	$f_{IN}$	47	50/60	63	Hz
Maximum Input Current ( $I_O = I_{O,max}$ )	$V_{IN,AC} = 480$ VAC	$I_{IN,max}$	-	-	15	A
No Load Input Power ( $V_O = On, I_O = 0A$ )	$V_{IN,AC} = 480$ VAC	$P_{IN,no-load}$	-	25	-	W
Turn On Delay via AC Mains	All	$t_{Turn-on}$	-	-	2.5	s
Harmonic Line Currents	All	THD	EN 61000-3-2			
Power Factor	$V_{IN,AC} = 380$ to $415$ VAC $V_{IN,AC} = 480$ VAC $F_{IN,AC} = 50/60$ Hz $I_O = 25\%I_{O,max}$ $I_O = 50\%I_{O,max}$ $I_O = 100\%I_{O,max}$	PF	-	0.92	-	-
			-	0.98	-	-
			-	0.98	-	-
			-	0.98	-	-
Startup Surge Current (Inrush)	$V_{IN,AC} = 480$ VAC	$I_{IN,surge}$	-	-	60	$A_{PK}$
Input Fuse (Double Line Fusing)	Internal, Fast acting, 500 VAC		-	-	20	A
Efficiency	$V_{IN,AC} = 480$ VAC $I_O = 10\% I_{O,max}$ $I_O = 20\% I_{O,max}$ $I_O = 50\% I_{O,max}$ $I_O = 80\% I_{O,max}$ $I_O = 100\% I_{O,max}$	$\eta$	-	91.5	-	%
			-	93.5	-	%
			-	97	-	%
			-	96.3	-	%
			-	96.3	-	%
System Stability	Phase Margin Gain Margin		45	-	-	$\emptyset$
			-6	-	-	dB

## SECTION 2 ELECTRICAL SPECIFICATIONS

### 2.3 Output Specifications

Table 3. Output - Module In Voltage Source Mode							
Parameter	Condition	Symbol	Min	Typ	Max	Unit	
Nominal Output Voltage	All	$V_O$	-	54.5	-	VDC	
Standby Output Voltage	All	$V_{Standby}$	-	-	5	VDC	
Output Current	All	$I_O$	0	-	183.5	A	
Standby Output Current	All	$I_{Standby}$	0	-	2	A	
Output Voltage Adjustment Range	All	$V_O$	48	-	60	VDC	
Programming Accuracy <sup>1</sup>	Via digital command	$\pm\%V_O$	-	-	0.5	%	
	Via analog	$\pm\%V_O$	-	-	1	%	
Output Static Regulation <sup>1</sup>	At steady state line	$\pm V_O$ $\pm V_{Standby}$	- -	- -	0.5 5	%	
	At steady state load	$\pm V_O$ $\pm V_{Standby}$	- -	- -	0.5 5	%	
Line Transient Regulation <sup>2</sup>	Peak Deviation	10% line change	$\pm V_O$ $\pm V_{Standby}$	- -	- -	3 5	%
Load Transient Regulation <sup>2</sup>	Peak Deviation	25% load change	$\pm\%V_O$	-	-	5	%
Output Ripple, pk-pk <sup>3, 4, 5, 6</sup>			$V_O$ $V_{Standby}$	- -	- -	1 100	% mV
Overshoot & Undershoot		$I_O = 0$ to 183.5A	$\pm\%V_O$	-	-	5	%
Output Load Capacitance	All	$C_O$	0	-	22000	$\mu$ F	
Output Rise Time		$V_O = 48$ VDC	$t_{Rise}$	-	70	-	ms
		$V_O = 54.5$ VDC		-	80	-	ms
		$V_O = 60$ VDC		-	88	-	ms
Hold Up Time <sup>7</sup>		$V_O = 54.5$ VDC	$t_{Hold-up}$	-	20	-	ms
		$P_O = 6$ kW, $P_O = 10$ kW		-	12	-	ms

Note 1 - Ambient temperature at 23°C  $\pm$  5°C (with 30 minutes warm-up period).

Note 2 - Minimum dynamic load is 9.175A; maximum test capacitance = 22,000  $\mu$ F.

Note 3 - The Value measured at room temperature, overload, and line range at the nominal output voltage.

Note 4 - In case the voltage is adjusted above the nominal setting, the ripple expected is 1% of the output voltage.

Note 5 - Main Output Ripple at absolute no load: PSU expected to enter burst operation mode, peak-to-peak ripple on main output shall still be 1% max pk-pk.

Note 6 - Ripple noise at extremely low temperatures (below 0°C) is expected higher until the unit gets stabilized due to the ESR change of the E-Caps. Ripple noise at -20°C ambient is expected to be around +/-10% of output voltage.

Note 7 - The main output remains within its error band for a minimum of 12 ms from a complete line loss, occurring at any point in the line cycle, at the maximum rated output loading when tested at nominal output voltage.

## SECTION 2 ELECTRICAL SPECIFICATIONS

### 2.4 System Timing Specifications

Table 4. System Timing Specifications					
Item	Parameter	Min	Typ	Max	Unit
Tac_Vreg	Delay from AC being applied to main output being within regulation.	-	-	2.5	s
Tac_acok_on	Delay from AC being applied to ACOK signal assertion (going Low).	-	-	1000	ms
TVreg_PWR_OK_ON	Delay from main output within regulation to PWR_OK# signal assertion (going Low).	10	-	500	ms
Tac_5Vsb_Vreg	Delay from AC being applied to 5Vsb being within regulation.	-	-	1.9	s
Tac_5Vsb_OFF	Delay from AC loss to 5Vsb going out of regulation.	120	-	-	ms
T_hold	Delay from AC loss to main output falling out of regulation. Main output at nominal set point. Output Power: 6 kW Output Power: 10 kW	-	-	20	ms
		-	-	12	ms
Tac_acok_off	Delay from AC loss to ACOK signal de-assertion (going High).	20	-	50	ms
TVreg_PWR_OK_OFF	Hold up time - time output voltages stay within regulation after the loss of AC.	100	-	-	us
Tpson#_Vreg	Delay from PSON# asserted (pulled LOW) to output voltages being within regulation.	5	-	400	ms
Tpson#_PWR_OK_OFF	Delay from PSON# going HIGH to PWR_OK deassertion.	-	-	300	ms
Tpskill_OFF	Delay from PSKILL going HIGH to main output turning off.	-	-	1	ms
Tpskill_Vreg	Delay from PSKILL deassertion (pulled LOW) to main output voltage being within regulation	5	-	400	ms



## SECTION 2 ELECTRICAL SPECIFICATIONS

### 2.5 System Timing Diagram

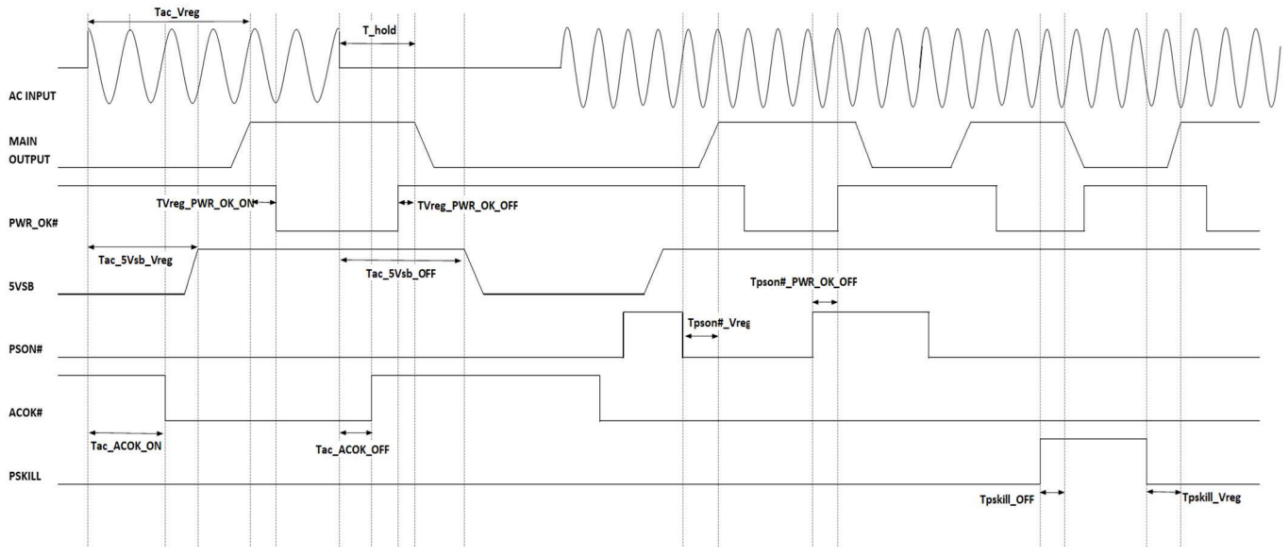

## SECTION 2 ELECTRICAL SPECIFICATIONS

### 2.6 FCM10K Performance Curves - Voltage Source Mode

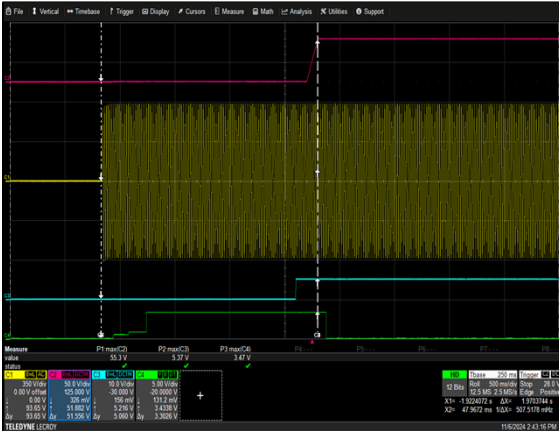

Figure 1: FCM10K Turn-on delay via AC mains  
 Vin = 480Vac Load: Io = 0A  
 Ch 1: Vin Ch 2: Vo Ch 3: VSB Ch 4: PWR\_OK

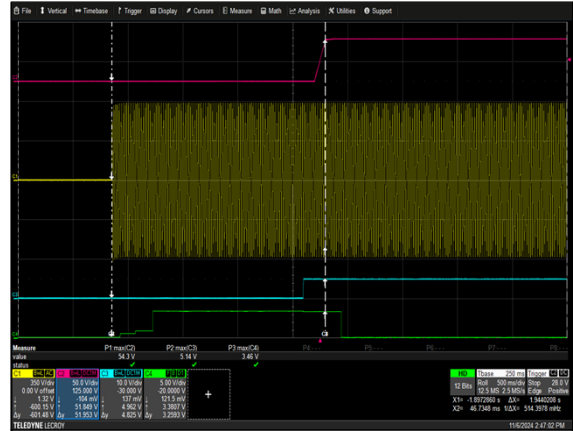

Figure 2: FCM10K Turn-on delay via AC mains  
 Vin = 520Vac Load: Io = 183.5A  
 Ch 1: Vin Ch 2: Vo Ch 3: VSB Ch 4: PWR\_OK

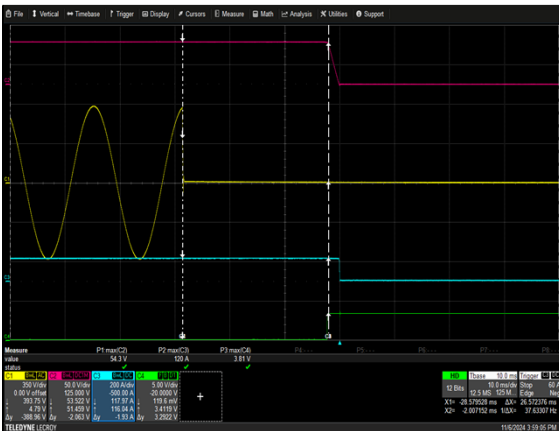

Figure 3: FCM10K Hold-up Time  
 Vin = 480Vac Load: Io = 110.1A Turn-Off Phase = 90°  
 Ch 1: Vin Ch 2: Vo Ch 3: Io Ch 4: PWR\_OK

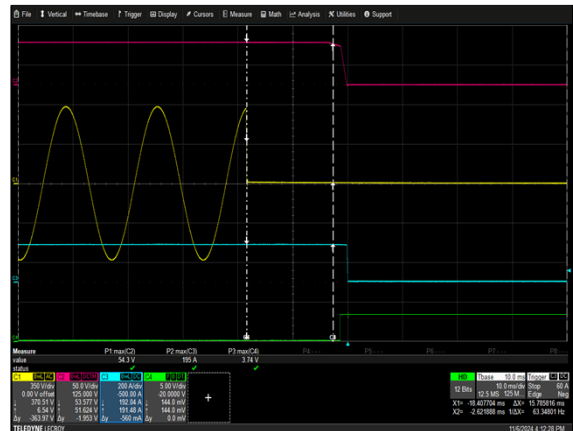

Figure 4: FCM10K Hold-up Time  
 Vin = 480Vac Load: Io = 183.5A Turn-Off Phase = 90°  
 Ch 1: Vin Ch 2: Vo Ch 3: Io Ch 4: PWR\_OK

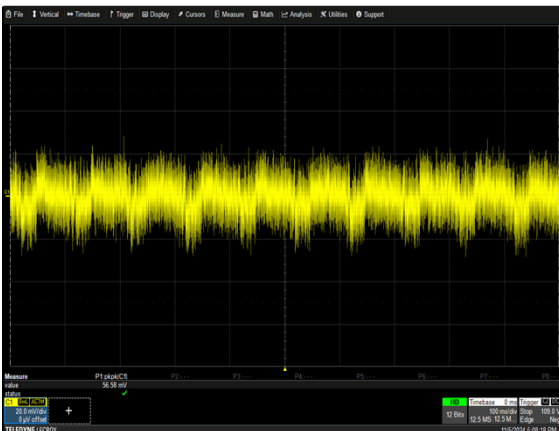

Figure 5: FCM10K Ripple and Noise Measurement  
 Vin = 480Vac Load: Io = 183.5A Resolution = 100ms  
 Ch 1: Vo

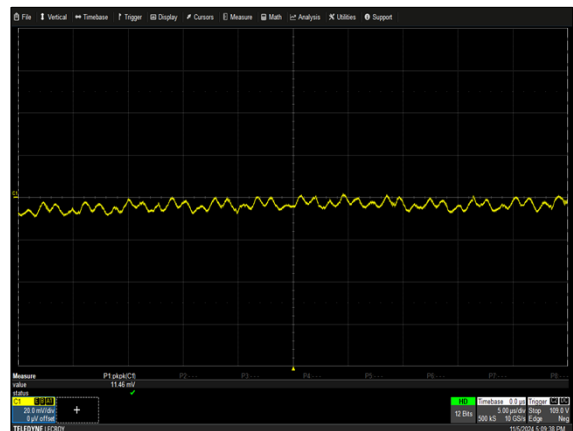

Figure 6: FCM10K Ripple and Noise Measurement  
 Vin = 480Vac Load: Io = 183.5A Resolution = 2 to 4 cycle  
 Ch 1: Vo

## SECTION 2 ELECTRICAL SPECIFICATIONS

### 2.6 FCM10K Performance Curves - Voltage Source Mode



Figure 7: FCM10K Transient Response - Vo Deviation  
 50% to 75% load change, 1A/uS slew rate Vin = 480Vac  
 Ch 1: Vo Ch 2: Io



Figure 8: FCM10K Transient Response - Vo Deviation  
 75% to 100% load change, 1A/uS slew rate Vin = 480Vac  
 Ch 1: Vo Ch 2: Io

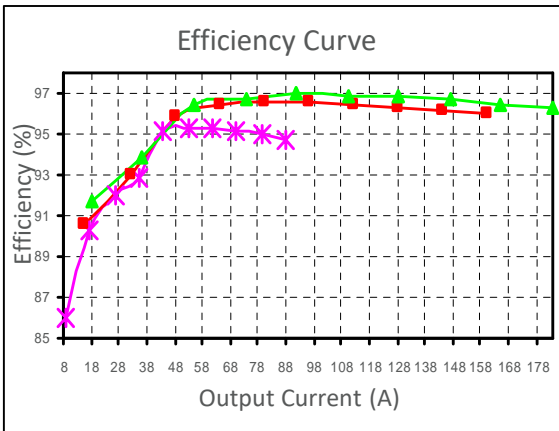

Figure 9: FCM10K Efficiency Curve @ 25°C  
 —\*— 208Vac —■— 380Vac —▲— 480Vac  
 Loading:  $I_{o,max} = 10\% I_{o,max}$  increment to  $I_{o,max}$

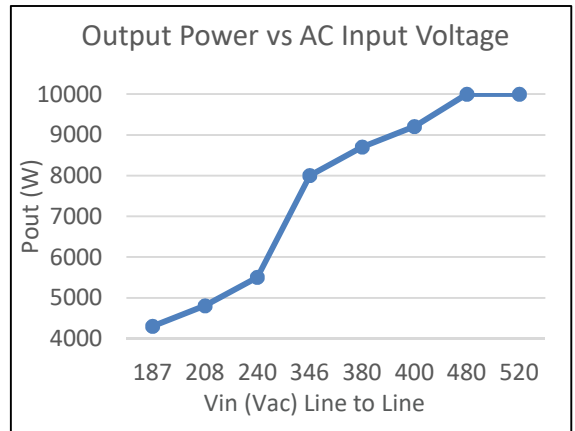

Figure 10: FCM10K Output Power vs AC Input Voltage

## SECTION 2 ELECTRICAL SPECIFICATIONS

### 2.7 Protection Function Specifications

#### Input Fuse

The FCM10K series is equipped with an internal non-user serviceable 20 A, 500 VAC fast acting fuse to protect against catastrophic failures.

#### Over Voltage Protection (OVP)

The FCM10K series power supply is internally protected against output overvoltage.

Parameter	Main Output
First level OVP	<ul style="list-style-type: none"> <li>Tracking OVP</li> <li>Scales with output voltage</li> <li>Threshold should be 115% (+/- 2%) of voltage set-point</li> <li>Output can be reset/turned ON using PSON, PSKILL, MODBUS, and AC recycle.</li> </ul>
Second level OVP	<ul style="list-style-type: none"> <li>Threshold should be 65V</li> <li>Output can be reset/turned ON using PSON, PSKILL, MODBUS, and AC recycle.</li> </ul>

#### Over Current Protection (OCP)

The FCM10K series power supply is internally protected against output overcurrent.

Parameter	Main Output
First level OCP	<ul style="list-style-type: none"> <li>Fixed setting at typical of 200A (109% of 183.5A)</li> <li>Output voltage droops down to 87.5% of Vout or 44V whichever comes first.</li> <li>Once the output voltage reaches, 87.5% of Vout or 44V, the unit detects it as a fault and the main output turns off.</li> <li>During voltage droop, if the output load was removed (No Load) expect a 5% - 115% overshoot on the main Output voltage.</li> <li>Main output will continue to do a slow 10-time retry (2s OFF, 10ms ON validation of Fault), if the output fault is still present then unit main o/p remains OFF.</li> <li>Output can be reset/turned ON using PSON, PSKILL, MODBUS, and AC recycle.</li> </ul>
Second level OCP	<ul style="list-style-type: none"> <li>Tracking with respect to maximum output current set</li> <li>Set at 120% of aximum output current set</li> <li>If current exceeds then immediate output shut down</li> <li>Main output will continue to do a slow 10-time retry (2s OFF, 10ms ON validation of Fault), if the output fault is still present then unit main O/P remains OFF.</li> <li>Output can be reset/turned ON using PSON, PSKILL, MODBUS, and AC recycle.</li> </ul>

#### Standby Output:

Parameter	Main Output
5V Standby OCP	<ul style="list-style-type: none"> <li>OCP is 115%-140% of its full load current</li> <li>5V standby output will continue to do slow 10 time retry, if the output fault is still present then latch 5V stand by</li> <li>Can be reset / turned ON using PSON, PSKILL, MODBUS and AC recycle</li> </ul>

## SECTION 2 ELECTRICAL SPECIFICATIONS

### Short Circuit Protection (SCP)

The FCM10K series outputs are protected from continuous output shorted conditions (no damage or reliability issues).

Parameter	Main Output
Main Output Short Circuit	<ul style="list-style-type: none"> <li>• Immediate shutdown</li> <li>• Main output will continue to do slow 10-time retry, if the output fault is still present then unit main o/p remains OFF</li> <li>• Output can be reset/turned ON using PSON, PSKILL, MODBUS, and AC recycle.</li> </ul>
5V Standby Short Circuit	<ul style="list-style-type: none"> <li>• Immediate shutdown</li> <li>• Auto recover</li> </ul>

### Over Temperature Protection (OTP)

The FCM10K series power supply is internally protected against over temperature conditions. When the OTP circuit is activated, the power supply will shut-off and auto-recover once the OTP condition is gone.

### Line Protection (AC Input Fault)

Parameter	Main Output
Wrong installation/connection of L1 ,L2, L3 on the PSU AC input connector or Shelf.	<ul style="list-style-type: none"> <li>• Example is L1 of the 3 phase AC input is connected to L2 or L3 terminal of the power supply</li> <li>• Power supply will not power up</li> </ul>
Loss of one AC input Phase	<ul style="list-style-type: none"> <li>• Power supply will shutdown</li> <li>• Power supply will recover when AC input goes back to operating range.</li> </ul>
AC input Over Voltage	<ul style="list-style-type: none"> <li>• When line-to-line voltage exceeds 535Vac, power supply will shutdown</li> <li>• Power supply will recover when AC input goes back to the nominal high line of 480Vac.</li> </ul>
AC input Under Voltage	<ul style="list-style-type: none"> <li>• Power supply shall maintain output regulation when AC input drops below the minimum AC input level of 187Vac for the given duration and output load below.</li> <li>• The AC input drop can be at any one phase/line or all 3 phases. <ul style="list-style-type: none"> <li>- One full AC cycle with a load of 6kW</li> <li>- Half AC cycle with a load of 10kW</li> </ul> </li> </ul>

## SECTION 3 MECHANICAL SPECIFICATIONS

### 3.1 Mechanical Outlines (-P) (unit: mm)

FCM10K: 81.6 mm (H) x 125.85 mm (W) x 460 mm (L)

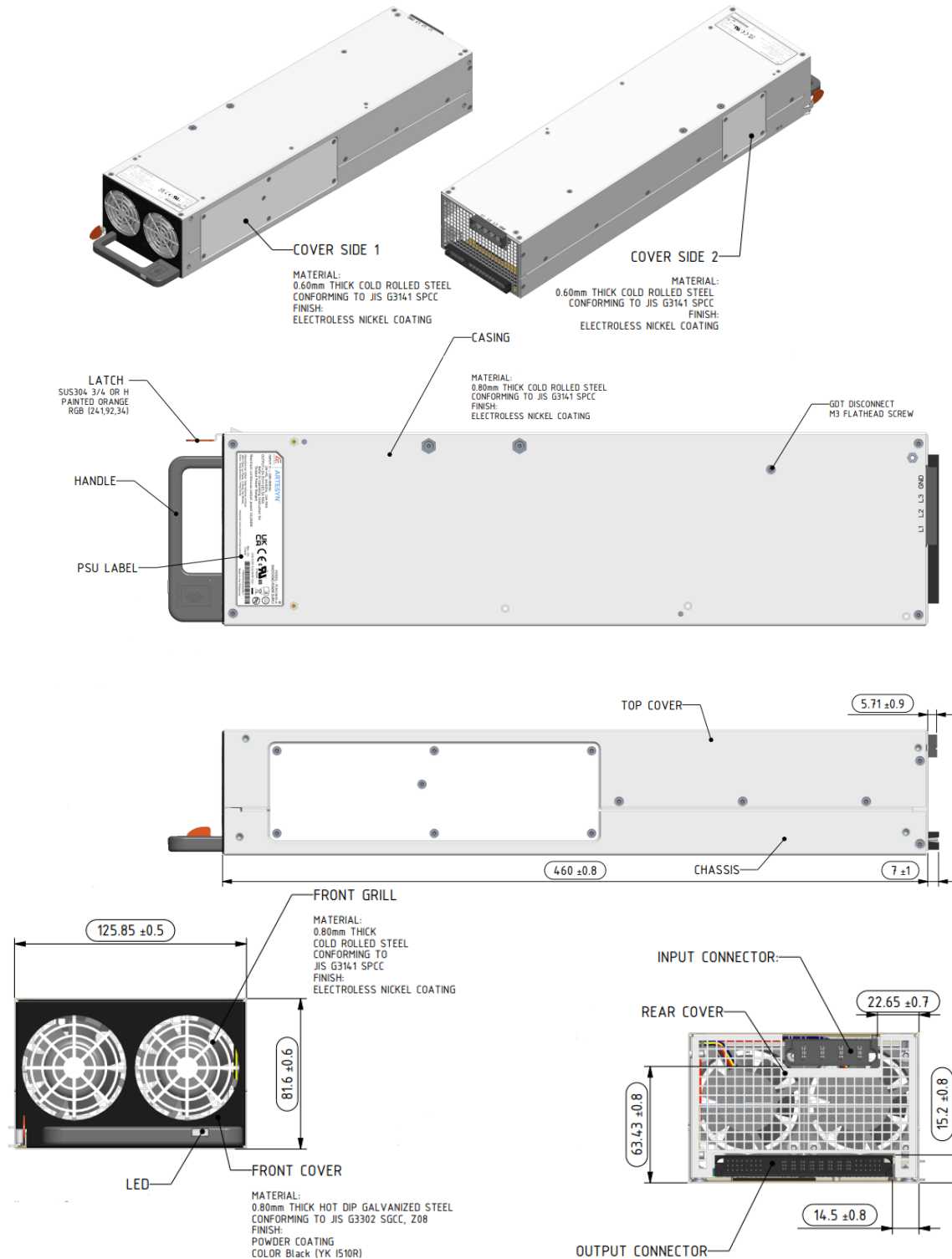

## SECTION 3 MECHANICAL SPECIFICATIONS

### 3.2 Mechanical Outlines (-T) (unit: mm)

FCM10K: 81.6 mm (H) x 125.85 mm (W) x 460 mm (L)

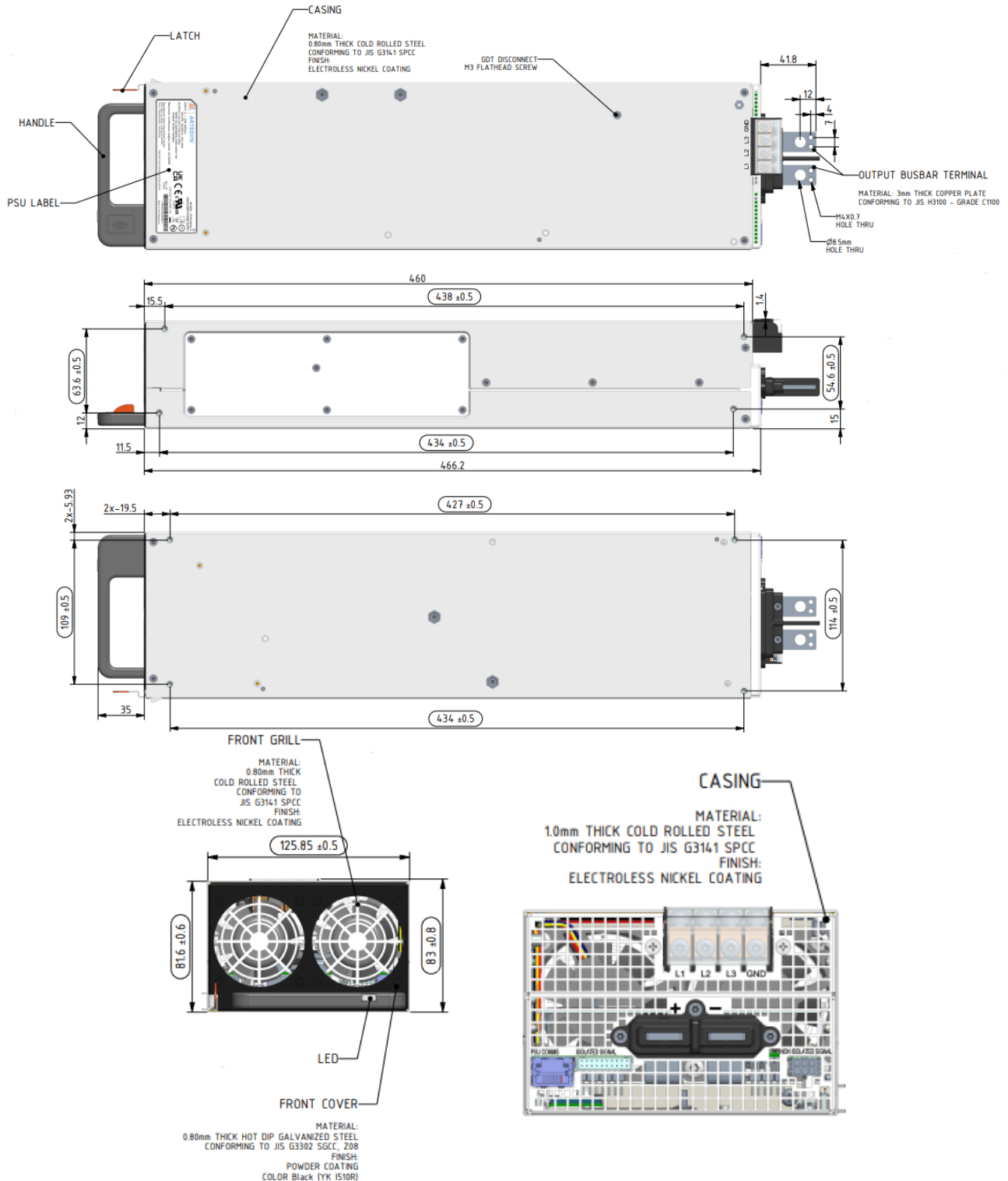

## SECTION 3 MECHANICAL SPECIFICATIONS

### 3.3 Connector Definitions (FCM10KW-N-P)

#### Input Connector – J25

- L1 – Line1
- L2 – Line2
- L3 – Line3
- GND – Earth Ground

Note 1- Three phase AC input using three wire and PE  
 Note 2- Supports star or Delta three phase (no corner grounding)



#### Output Terminal

- P2-P5 - Main Output (+)
- P6-P9 - Main Output Return (-)

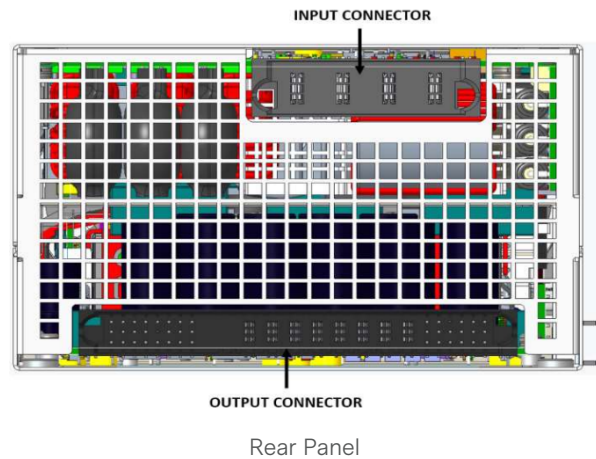

#### Non-Isolated Signals

- C10 – SYS\_GND
- C11 – PSKILL
- C9 – ISHARE\_RETURN
- C14 – ISHARE
- B12 – SHLF\_DET
- C13 – PSU\_SYNC

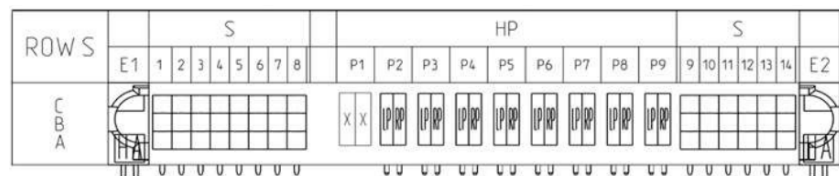
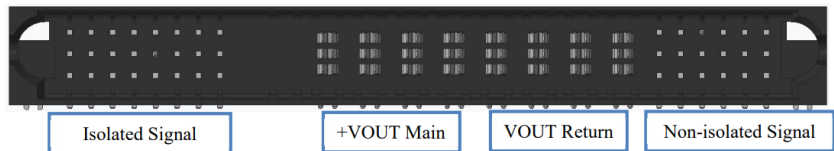

Output Connector



## SECTION 3 MECHANICAL SPECIFICATIONS

### 3.3 Connector Definitions (FCM10KW-N-P)

#### Isolated Signals

- B2 – 5VSB\_GND
- A1 – 5VSB
- B6 – RS485\_GND
- B3<sup>1</sup> – V\_PROG
- A7 – RS485\_ADDR0
- A8 – GNDL
- C7 – RS485\_ADDR1
- B1 – ACOK#
- C8 – RS485\_ADDR2
- C1 – PWR\_OK#
- C5 – RS485\_A\_EXT
- C3 – PSON#
- C6 – RS485\_B\_EXT
- C4 – CC/CV\_MODE
- B8 – PSU\_PRESENT
- A2 – PSU\_SYNC\_ISO
- A3 – ANALOG/DIGITAL\_MODE
- C2 – I\_PROG
- A5 – VPROG/IPROG\_GND
- B4 – ALERT#

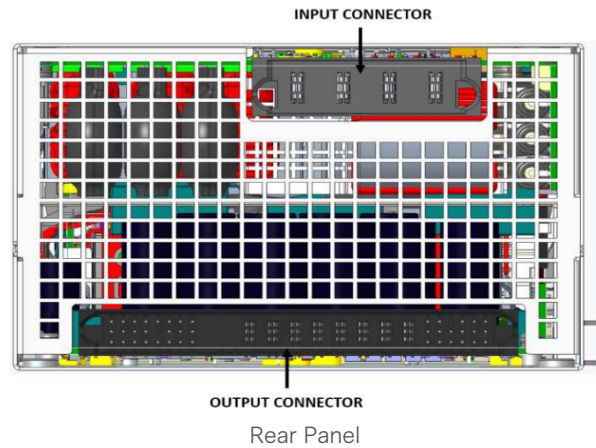

Note 1 - To enable Vout trimming using external supply voltage, You need to short ANALOG/DIGITAL\_MODE pin to GNDL pin. Apply external voltage 0 to 10 V across V\_PROG pin and GNDL pin. No need to short ANALOG/ DIGITAL\_MODE pin to GNDL pin by default Vout trimming is thru RS485

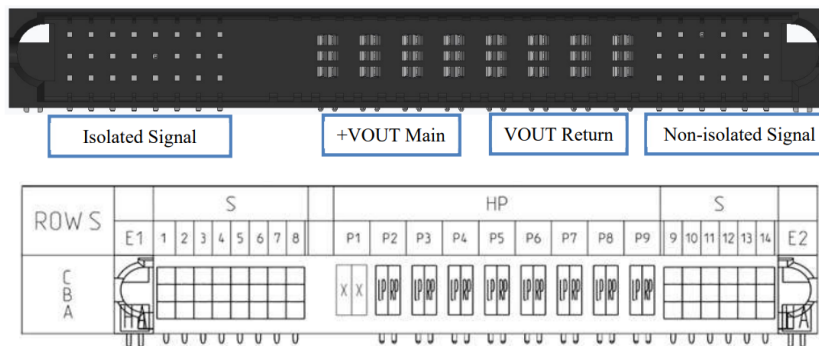

Output Connector Pin Diagram

## SECTION 3 MECHANICAL SPECIFICATIONS

### 3.4 Connector Definitions (FCM10KW-N-T)

#### Input Connector

- L1 – Line1
- L2 – Line2
- L3 – Line3
- GND – Earth Ground

Note 1- Three phase AC input using three wire and PE  
 Note 2- Supports star or Delta three phase(no corner g

#### Output Terminal

- Main Output (+)
- Main Output Return (-)

#### Non-Isolated Signals - J5

- Pin 1 – SYS\_GND
- Pin 2 – N/A
- Pin 3 – ISHARE\_RETURN
- Pin 4 – ISHARE
- Pin 5 – SHLF\_DET
- Pin 6 – PSU\_SYNC

#### Communication Connector Signals – J2

- Pin 1 – RS485A
- Pin 2 – RS485B
- Pin 3 – N/A
- Pin 4 – N/A
- Pin 5 – N/A
- Pin 6 – N/A
- Pin 7 – N/A
- Pin 8 – RS485\_GND

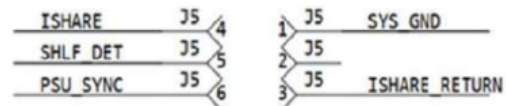
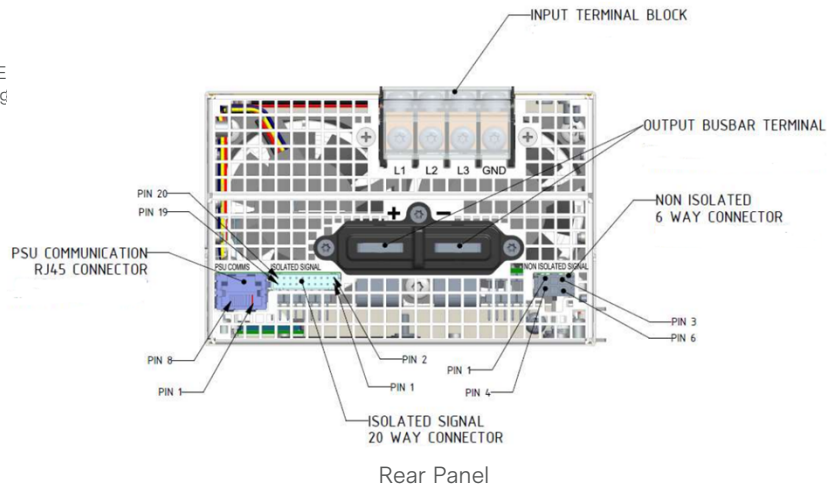

Non-isolated Signals

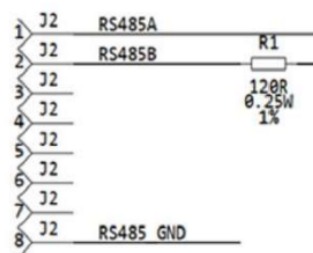

Communication Connector Signals

## SECTION 3 MECHANICAL SPECIFICATIONS

### 3.4 Connector Definitions (FCM10KW-N-T)

#### Isolated Signals – J3

- Pin 1 – 5VSB\_GND
- Pin 2 – 5VSB
- Pin 3 – RS485\_GND
- Pin 4 – V\_PROG
- Pin 5 – RS485\_ADDR0
- Pin 6 – GNDL
- Pin 7 – RS485\_ADDR1
- Pin 8 – ACOK#
- Pin 9 – RS485\_ADDR2
- Pin 10 – PWR\_OK#
- Pin 11 – RS485\_A\_EXT
- Pin 12 – PSON#
- Pin 13 – RS485\_B\_EXT
- Pin 14 – CC/CV\_MODE
- Pin 15 – PSU\_PRESENT
- Pin 16 – PSU\_SYNC\_ISO
- Pin 17 – ANALOG/DIGITAL\_MODE
- Pin 18 – I\_PROG
- Pin 19 – VPROG/IPROG\_GND
- Pin 20 – ALERT#

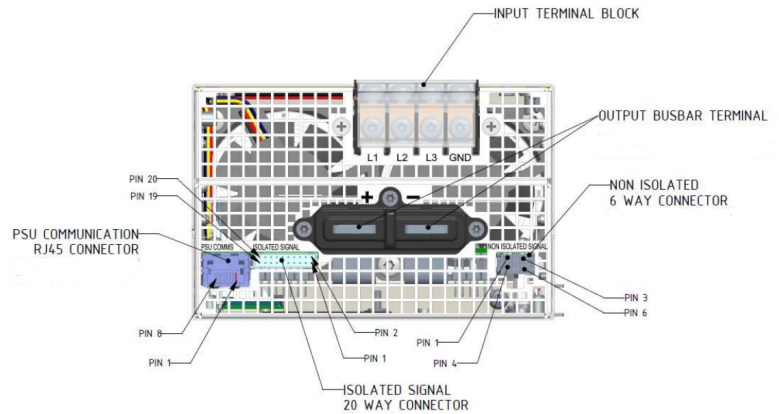

Rear Panel



Isolated Signals

Note 1 - To enable Vout trimming using external supply voltage, You need to short ANALOG/DIGITAL\_MODE pin to GNDL pin. Apply external voltage 0 to 10 V across V\_PROG pin and GNDL pin. No need to short ANALOG/ DIGITAL\_MODE pin to GNDL pin by default Vout trimming is thru RS485

## SECTION 3 MECHANICAL SPECIFICATIONS

### 3.5 Power / Signal Mating Connectors and Pin Types

Table 5. Mating Connectors for FCM10KW-N-P		
Reference	On Power Supply	Mating Connector or Equivalent
Input Connector	Amphenol-FCI: 10106262-4000006LF	Amphenol-FCI: 10128858-177LF
Output Connector	Amphenol-FCI: 10127397-00H4014LF	Amphenol-FCI: 10127401-00H4014LF

Table 6. Mating Connectors for FCM10KW-N-T		
Reference	On Power Supply	Mating Connector or Equivalent
Input Connector	764-001553-00XX	
Output Terminal	500-011906-00XX	
Non-Isolated Signals	Molex: 43045-0602	Molex: 43025-0600
Isolated Signals	Landwin: 2052P2000T-01 CVILUX: CI0120P1HDC-NH	Landwin: 2052S20 00
Communication Connector Signals	Molex: 43202-8819	FCC 68 Plugs

## SECTION 3 MECHANICAL SPECIFICATIONS

### 3.6 LED Indicator Definitions

One bi-color (blue/amber) LED is provided on the power supply chassis at the end opposite to the input-output connectors. The status LED conditions is shown on the table below.

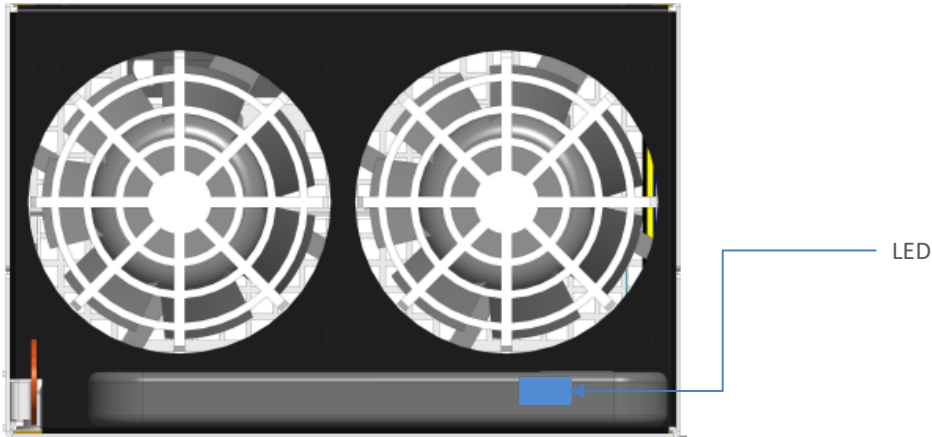

Conditions	LED Status
AC present, main output ON, standby output ON	Solid Blue
Standby mode	Blinking Blue (1s ON; 1s OFF)
Any kind of fault (output over voltage/over current/over temperature/ short circuit)	Solid Amber
In system programming	Fast Blinking Blue (0.5s ON; 0.5s OFF)
Wrong installation/connection of L1, L2 or L3 on the PSU AC input connector or Shelf	Blinking Amber (1s ON; 1s OFF)
AC input under voltage/over voltage/out of operating condition	Blinking Amber (3s ON; 3s OFF)

## SECTION 3 MECHANICAL SPECIFICATIONS

### 3.7 Weight

The FCM10K series weight is 5.3kg.

## SECTION 4 NFC TAG SPECIFICATIONS

### NFC Tag Interface (FCM10KW Series)

The power supply comes with a Passive NFC tag device located on its handle. Users can read and configure the power supply parameters even if the power supply is not powered. As shown on the diagram an NFC Phone or RFID reader device will be able to read and access the NFC Tag.

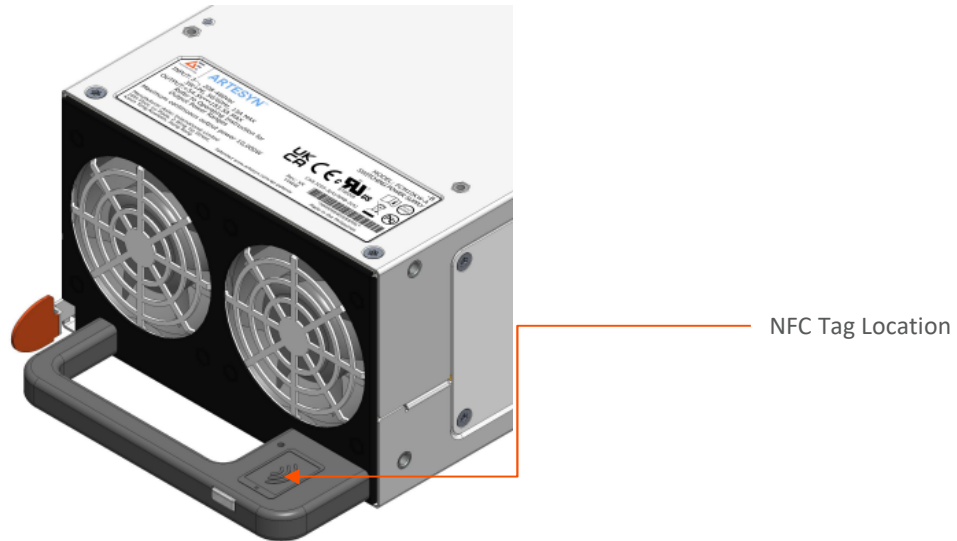

As shown on the diagram an NFC Phone or RFID reader device will be able to read and access the NFC Tag using suitable application developed by AEI.

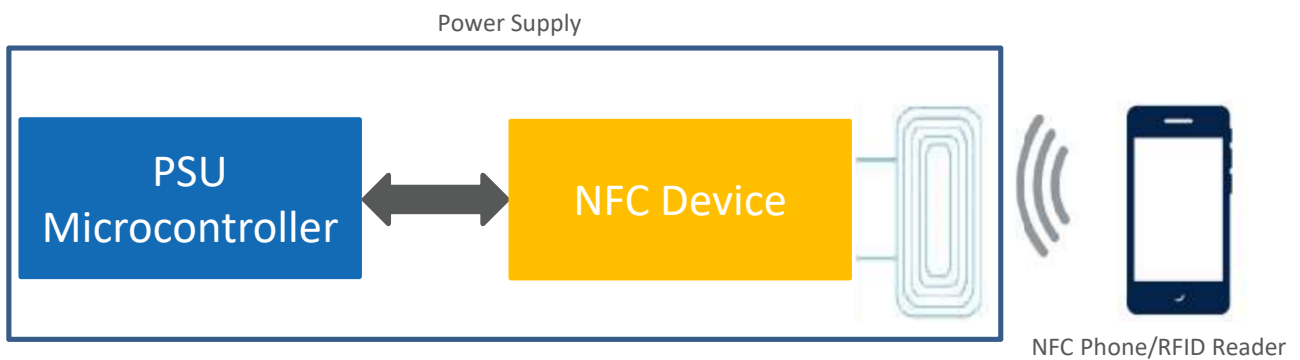

## SECTION 5 ENVIRONMENTAL SPECIFICATIONS

### 5.1 EMC Immunity

FCM10K series power supply is designed to meet the following EMC immunity specifications.

Table 7. Environmental Specifications			
Test Items	Standard	Test Level	Criteria <sup>1</sup>
Conducted Emissions	CISPR 32/EN 55032	Class B. 150k to 30MHz	6dB Margin, average
Radiated Emissions	CISPR 32/EN 55032, FCC CFR 47 Part 15 Subpart B	Class B. 30M to 1GHz	6dB Margin, average
Harmonic Current Emissions	EN 61000-3-2	-	-
Voltage Fluctuations	IEC 61000-3-3	-	-
Electro Static Discharge (ESD) Immunity	EN/IEC 61000-4-2	8kV contact, 15kV air 6kV contact, 8kV air	A A
Radiated RF EM Fields Susceptibility	EN/IEC 61000-4-3	80MHz-1GHz, Level 3 (10V/m)	A
Electrical Fast Transients (EFT) / Bursts	EN/IEC 61000-4-4	AC Power Port: +/-4kV I/O Signal Port: +/-0.5kV	A B
Surges - Line to Line (DM) and Line to GND (CM)	EN/IEC 61000-4-5 IEEE C62.41	2kV DM, 4kV CM 2kV DM, 2kV CM	A A
Conducted Immunity	EN/IEC 61000-4-6	150kHz-80MHz, Level 3 (10V/m)	A
Power Frequency Magnetic Field Immunity	EN 61000-4-8	50kHz, Level 3 (10A/m)	A
Voltage Dips and Interruptions	IEC 61000-4-11	10ms, >95% Reduction 500ms, >30% Reduction 5s, >95% Reduction 500ms, >95% Reduction	A A C C

Note 1 - Performance criteria of EN61000-4-X standards as defined by EN55035. According to the standards, performance criteria are defined as following:

Performance criterion A: During and after the test, no degradation of performance or loss of function is allowed below a minimum performance level in the EUT specifications.

Performance criterion B: During the test, temporary degradation of performance is allowed which is self-recoverable, without change in operating state. After the application of the disturbance, no degradation of performance or loss of function is allowed.

Performance criterion C: Loss of function is allowed, provided the function is self-recoverable, or can be restored by the operation of the controls by the user. A reboot or re-start is allowed.



## SECTION 5 ENVIRONMENTAL SPECIFICATIONS

### 5.2 Safety Certifications

The FCM10K series are intended for inclusion in other equipment and the installer must ensure that it is in compliance with all the requirements of the end application. This product is only for inclusion by professional installers within other equipment and must not be operated as a standard alone product.

Table 8. Safety Certifications for FCM10K Series Power Supply System		
Standard	Agency	Description
UL 62368-1, 3 <sup>rd</sup> Ed Recognized	UL	US
CAN/CSA C22.2 No. 62368-1:19, 3 <sup>rd</sup> Ed		Canada Requirements
EN IEC 62368-1: 2020/A11:2020	TUV	European Requirements
IEC 62368-1: 2018 3 <sup>rd</sup> Edition		International Electrotechnical Commission
CE (LVD + RoHS), EN 62368-1 3 <sup>rd</sup> Edition		European Requirements
CB Certifications and Report		All CENELEC Countries

## SECTION 5 ENVIRONMENTAL SPECIFICATIONS

### 5.3 EMI Emissions

The FCM10K series has been designed to comply with the Class A limits of EMI requirements of EN55032 for emissions and relevant sections of EN61000 (IEC 61000) for immunity. The unit is tested at 10000 W load.

#### Conducted Emissions

The applicable standard for conducted emissions is EN55032. Conducted noise can appear as both differential mode and common mode noise currents. Differential mode noise is measured between the two input lines, with the major components occurring at the supply fundamental switching frequency and its harmonics. Common mode noise, a contributor to both radiated emissions and input conducted emissions, is measured between the input lines and system ground and can be broadband in nature.

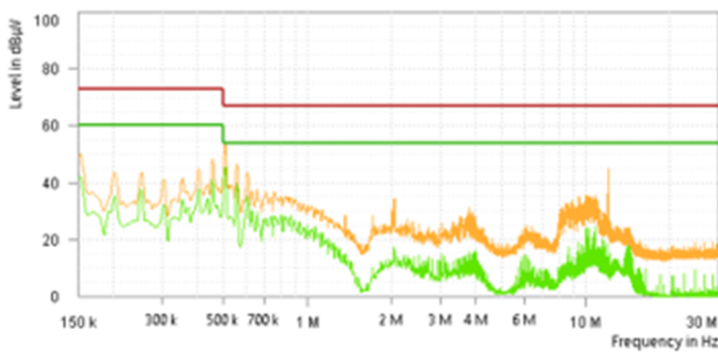

The FCM10K series has internal EMI filters to ensure the converters' conducted EMI levels comply with EN55032 Class A limits. The EMI measurements are performed with resistive loads at maximum rated loading.

Sample of EN55032 Conducted EMI Measurement at 480 Vac three phase input.

Conducted EMI emissions specifications of the FCM10K series power system:

Parameter	Model	Symbol	Min	Typ	Max	Unit
FCC Part 15, class A	All	Margin	6	-	-	dB
CISPR 32 (EN55032), class A	All	Margin	6	-	-	dB

## SECTION 5 ENVIRONMENTAL SPECIFICATIONS

### Radiated Emissions

Unlike conducted EMI, radiated EMI performance in a system environment may differ drastically from that in a stand-alone power supply. The shielding effect provided by the system enclosure may bring the EMI level from Class A to Class B. It is thus recommended that radiated EMI be evaluated in a system environment. The applicable standard is EN55032 Class A. Testing ac-dc convertors as a stand-alone component to the exact requirements of EN55032 can be difficult, because the standard calls for 1 m leads to be attached to the input and outputs and aligned such as to maximize the disturbance. In such a set-up, it is possible to form a perfect dipole antenna that very few AC-DC convertors could pass. However, the standard also states that an attempt should be made to maximize the disturbance consistent with the typical application by varying the configuration of the test sample.

## SECTION 5 ENVIRONMENTAL SPECIFICATIONS

### 5.4 Operating Temperature

The FCM10K series power supplies can start and operate within the stated specifications at an ambient temperature from -40°C to 50°C under all load conditions with an internal fan (full performance). Above 50°C to 70°C, the output power will be derated linearly. The FCM10K series power supplies are able to start at -40°C rated full load.

### 5.5 Forced Air Cooling

The FCM10K series power supplies will operate with forced air. Fan noise 63dB with 60% load at 30°C. The fan speed is internally controlled by the PSU and will vary depending on its internal thermal sense circuit. The worst case fan noise will not exceed 75 dBA (average).

Ambient Temp	Loading Condition	Fan Noise
≤ 30°C	60%	>63 dB

Note: To aide in dust control, fans will be turned off when the main output is off.

## SECTION 5 ENVIRONMENTAL SPECIFICATIONS

### 5.6 Storage Temperature

The FCM10K series can be stored or shipped at temperatures between -40°C to +85°C.

### 5.7 Altitude

The FCM10K series will operate within specifications at altitudes up to 9,842.52 feet (3,000 meters) above sea level. The power supply shall not be damaged when stored at altitudes of up to 30,000 feet (9,144 meters) above sea level.

### 5.8 Humidity

The FCM10K series will operate within specifications when subjected to a relative humidity from 20% to 90% non-condensing. The FCM10K series can be stored in a relative humidity from 10% to 95% non-condensing.

### 5.9 Vibration

The FCM10K series will pass the following vibration specifications:

Non-Operating Random Vibration (Class I Acceleration Specification)

Acceleration	1.9	gRMS	
Duration	30	Mins	
Direction	3 mutually perpendicular axis		
PSD Profile	FREQ (Hz)	SLOPE (db/oct)	PSD (g <sup>2</sup> /Hz)
	5	/	0.01
	200	/	0.01
	500	/	0.003

Non-Operating Random Vibration (Class II Acceleration Specification)

Acceleration	3.8	gRMS	
Duration	30	Mins	
Direction	3 mutually perpendicular axis		
PSD Profile	FREQ (Hz)	SLOPE (db/oct)	PSD (g <sup>2</sup> /Hz)
	5	/	0.052
	200	/	0.052
	500	/	0.003

## SECTION 5 ENVIRONMENTAL SPECIFICATIONS

Operating Random Vibration (Class I Acceleration Specification)

Acceleration	0.71	gRMS	
Duration	30	Mins	
Direction	3 mutually perpendicular axis		
PSD Profile	FREQ (Hz)	SLOPE (db/oct)	PSD (g <sup>2</sup> /Hz)
	5	/	0.000229
	30	/	0.0021
	200	/	0.0021
	500	/	0.000054

Operating Random Vibration (Class II Acceleration Specification)

Acceleration	2.4	gRMS	
Duration	30	Mins	
Direction	3 mutually perpendicular axis		
PSD Profile	FREQ (Hz)	SLOPE (db/oct)	PSD (g <sup>2</sup> /Hz)
	5	/	0.00046
	30	/	0.0052
	200	/	0.0052
	500	/	0.0001

## SECTION 5 ENVIRONMENTAL SPECIFICATIONS

### 5.10 Shock

The FCM10K series will pass the following shock specifications:

Operating Half-Sine Shock

Acceleration	30	G
Duration	11	ms
Pulse	Half-Sine	
Number of Shock	3 shocks for each of the six axes	

Non- operating Half-Sine Shock

Acceleration	40	G
Duration	15	ms
Pulse	Half-Sine	
Number of Shock	3 shocks for each of the six axes	

## SECTION 6 POWER AND CONTROL SIGNAL DESCRIPTIONS

### 6.1 Input Terminal

This connector supplies the AC Mains to the FCM10K series power supply.

L1 – Line1

L2 – Line2

L3 – Line3

GND – Earth Ground

PSU Input Voltage		
Nominal	Range	Remarks
208 Vac	187 to 229 VAC	Derived from 3 phase 208 VAC Mains (Line-to-Line)
240 Vac	216 to 264 VAC	Derived from 3 phase 240 VAC Mains (Line-to-Line)
346 Vac	311 to 381 VAC	Derived from 3 phase 346 VAC Mains (Line-to-Line)
380 Vac	342 to 418 VAC	Derived from 3 phase 380 VAC Mains (Line-to-Line)
400 Vac	360 to 480 VAC	Derived from 3 phase 400 VAC Mains (Line-to-Line)
480 Vac	432 to 528 VAC	Derived from 3 phase 480 VAC Mains (Line-to-Line)

### 6.2 Output Terminal (-P)

This connector provides the main output for the FCM10K series power supply.

P2-P5 - Main Output (+)

P6-P9 - Main Output Return (-)

### 6.3 Output Terminal (-T)

This connector provides the main output for the FCM10K series power supply.

Main Output (+)

Main Output Return (-)



## SECTION 6 POWER AND CONTROL SIGNAL DESCRIPTIONS

### 6.4 Isolated Signals

#### RS485\_A\_EXT (C5, Pin 11 of J3)

Communication lines for RS485 Modbus Protocol.

The 120 Ohm terminating resistor is not available inside the PSU and should be added externally.

#### RS485\_B\_EXT (C6, Pin 13 of J3)

Communication lines for RS485 Modbus Protocol.

The 120 Ohm terminating resistor is not available inside the PSU and should be added externally.

#### RS485 RTN (B6, Pin 3 of J3)

Communication lines RTN for RS485 Modbus Protocol.

#### RS485\_ADDR0 # (A7, Pin 5 of J3)

Communication line address. Internally pulled up to 3V\_ISO via 10kOhm resistor.

External interface:

Logic Low: short address line to GNDL

Logic High: float address line or use open collector.

#### RS485\_ADDR1 # (C7, Pin 7 of J3)

Communication line address. Internally pulled up to 3V\_ISO via 10kOhm resistor.

External interface:

Logic Low: short address line to GNDL

Logic High: float address line or use open collector.

#### RS485\_ADDR2 # (C8, Pin 9 of J3)

Communication line address. Internally pulled up to 3V\_ISO via 10kOhm resistor.

External interface:

Logic Low: short address line to GNDL

Logic High: float address line or use open collector.

#### ACOK# (B1, Pin 8 of J3)

Active low signal. Indicates that the input supply voltage is within allowable limits and the power supply can be used and turned on. Internally pulled up to 3V\_ISO via 10kOhm resistor.

#### PWR\_OK# (C1, Pin 10 of J3)

Active low signal. Indicates that the main output is within the regulation band. Internally pulled up to 3V\_ISO via 10kOhm resistor.

## SECTION 6 POWER AND CONTROL SIGNAL DESCRIPTIONS

### ALERT# (B4, Pin 20 of J3)

Active low signal. Indicates that there is a fault present in the power supply. Internally pulled up to 3V\_ISO via 10kOhm resistor.

### PSON# (C3, Pin 12 of J3)

Active low signal as default. Controls the main output of the power supply on and off. Internally pulled up to 3V\_ISO via 10kOhm resistor.

Configurable to active high to allow power supply to operate without waiting for an external switch from the user as a stand-alone power supply.

Logic Low: short PSON# pin to GNDL

Logic High: float PSON# or use open collector

### V\_PROG (B3, Pin 4 of J3)

An analog programming command that accepts a DC voltage up to 10V in order to adjust the output voltage set points when the power supply is in voltage source mode operation.

0-10V programming range ( default range).

0-5V programming range (needs H/W or software modification).

### I\_PROG (C2, Pin 18 of J3)

An analog programming command that accepts a DC voltage up to 10V in order to adjust the output current set points when the power supply is in current source mode operation.

0-10V programming range ( default range).

0-5V programming range (needs H/W or software modification).

### CC/CV\_MODE (C4, Pin 14 of J3)

Sets the power supply to current source mode or voltage source operation. Shorting to isolated return (ISO\_RTN) will set the power supply to the current source mode. The open pin can be set to voltage source mode. Internally pulled up to 3V\_ISO via 10kOhm resistor.

### PSU\_PRESENT (B8, Pin 15 of J3)

Used by the shelf to detect the presence of power supply inside the shelf whether operating or not. Internally shorted to isolated signal return ground.

### GNDL (A8, Pin 6 of J3)

The isolated signal RTN (or ground).

### 5VSB\_GND# (B2, Pin 1 of J3)

This signal is the RTN of 5V standby output.

### 5VSB# (A1, Pin 2 of J3)

This pin is the standby output of the power supply rated 5V/2A.

## SECTION 6 POWER AND CONTROL SIGNAL DESCRIPTIONS

### PSKILL\_ISO (B5)

This signal has a short pin in the output connector. It functions as the first break/ last mate. This enables or disables the main output of the power supply. When this signal is shorted to ISO\_RTN by the system, the main output shall be enabled. The signal can source a maximum of 1mA in this state. When this signal is opened by the power supply removal from the system, the main output will shut down within TBA us.

### ANALOG/DIGITAL\_MODE (A3, Pin 17 of J3)

Set the method of Vout or Iout trimming.

- Pulled to GNDL will enable Vout and Iout trimming via analog (V\_PROG and I\_PROG)
- Open will enable Vout and Iout trimming via digital command (RS485).

Internally pulled up to 3V\_ISO via 10kOhm resistor.

### VPROG/IPROG\_GND (A5, Pin 19 of J3)

Return signal for VPROG and IPROG

## SECTION 6 POWER AND CONTROL SIGNAL DESCRIPTIONS

### 6.5 Non- Isolated Signals

#### PSKILL (C11)

This signal has short pin in the output connector. It functions as the first break/ last mate. This enables or disables the main output of the power supply. When this signal is shorted to SYS\_GND by the system, the main output shall be enabled. The signal can source a maximum of 1mA in this state. When this signal is opened by the power supply removal from the system, the main output will shut down within TBA us.

It should be configurable to active low to allow the power supply to operate without waiting for an external switch from the user as a stand-alone power supply

#### ISHARE (C14, Pin 4 of J5)

Provides active current sharing feature for main output using single wire loop signal connection. This signal should be tied with the same signal of other the power supply intended to do current sharing. Short trace length with a good ground (SYS\_GND) shield is recommended for better performance on the system back plane.

#### ISHARE\_RETURN (C9, Pin 3 of J5)

This signal is the RTN of ISHARE. Same reference ground for main output.

#### SYS\_GND (C10, Pin 1 of J5)

Non-isolated signal return (or ground). Same reference ground for the main output.

#### PSU\_SYNC (C13, Pin 6 of J5)

This signal allows multiple power supplies in parallel to synchronize start-up. This signal is connected together in the backplane/ shelf. Low on this pin (< 0.7V) disables the power supply to start up high on this pin (3V) enables the power supply to start up. Internally pulled up to 3V via 10kOhm resistor.

## SECTION 7 COMMUNICATION BUS DESCRIPTIONS

### FRU (EEPROM) Data

The FCM10K series uses 1 page of EEPROM for FRU purpose. A page of EEPROM contains up to 118 byte-sized data locations.

Where:	OFFSET	-The OFFSET denotes the address in decimal format of a particular data byte within FCM10K Series EEPROM.
	VALUE	-The VALUE details data written to a particular memory location of the EEPROM.
	DEFINITION	-The contents DEFINITION refers to the definition of a particular data byte.

FCM10K Series FRU (EEPROM) Data:

OFFSET		DEFINITION	SPEC VALUE	
(DEC)	(HEX)	(REMARKS)	(DEC)	(HEX)
0	00	<b>PSU_MODEL_ID</b>		
1	01	"S" = 53h	83	53
2	02	"O" = 30h	48	30
3	03	"7" = 37h	55	37
		"6" = 36h	54	36
4	04	<b>PSU_MFR_MODEL</b>		
5	05	"F" = 46h	70	46
6	06	"C" = 43h	67	43
7	07	"M" = 4Dh	77	4D
8	08	"1" = 31h	49	31
9	09	"O" = 30h	48	30
10	0A	"K" = 4Bh	75	4B
11	0B	"W" = 57h	87	57
12	0C	"_" = 2Dh	45	2D
13	0D	"N" = 50h	78	4E
14	0E	"_" = 2Dh	45	2D
15	0F	"P" = 50h ("T" = 54h )	80/84	50/54
16	10		32	20
17	11		32	20
18	12		32	20
19	13		32	20
20	14		32	20
21	15		32	20
22	16		32	20
23	17		32	20
24	18	<b>PSU_MFR_LOCATION</b>		
25	19	"L" = 4Ch	76	4C
26	1A	"A" = 41h	65	41
27	1B	"G" = 47h	71	47
28	1C	"U" = 55h	85	55
29	1D	"N" = 4Eh	78	4E
30	1E	"A" = 41h	65	41
31	1F		32	20
32	20		32	20
33	21		32	20
34	22		32	20
35	23		32	20
36	24		32	20
37	25		32	20
38	26		32	20
39	27		32	20
40	28		32	20
41	29		32	20
42	2A		32	20
43	2B		32	20

## SECTION 7 COMMUNICATION BUS DESCRIPTIONS

FCM10K Series FRU (EEPROM) Data:

OFFSET		DEFINITION (REMARKS)	SPEC VALUE	
(DEC)	(HEX)		(DEC)	(HEX)
		<b>PSU_MFR_DATE</b>		
44	2C	"W" = 57h	87	57
45	2D	"W" = 57h	87	57
46	2E	"/" = 2Fh	47	2F
47	2F	"Y" = 59h	89	59
48	30	"Y" = 59h	89	59
49	31	"Y" = 59h	89	59
50	32	"Y" = 59h	89	59
51	33		32	20
52	34	"s" = 73h	115	73
53	35	"s" = 73h	115	73
54	36	"s" = 73h	115	73
55	37	"s" = 73h	115	73
56	38	"s" = 73h	115	73
57	39		32	20
58	3A		32	20
59	3B		32	20
60	3C		32	20
61	3D		32	20
62	3E		32	20
63	3F		32	20
64	40		32	20
65	41		32	20
66	42		32	20
67	43		32	20
68	44		32	20
69	45		32	20
70	46		32	20
71	47		32	20
		<b>PSU_HW_REVISION</b>		
72	48	"Z" = 5Ah	90	5A
73	49	"Z" = 5Ah	90	5A
74	4A	"Z" = 5Ah	90	5A
75	4B		32	20
		<b>PSU_FW_REVISION</b>		
76	4C		32	20
77	4D		32	20
78	4E		32	20
79	4F		32	20
80	50		32	20
81	51		32	20
82	52		32	20
83	53		32	20
84	54		32	20
85	55		32	20
86	56		32	20
87	57		32	20
88	58		32	20
89	59		32	20
90	5A		32	20
91	5B		32	20
92	5C		32	20
93	5D		32	20
94	5E		32	20
95	5F		32	20
96	60		32	20
97	61		32	20
98	62		32	20
99	63		32	20

## SECTION 7 COMMUNICATION BUS DESCRIPTIONS

FCM10K Series FRU (EEPROM) Data:

OFFSET		DEFINITION (REMARKS)	SPEC VALUE	
(DEC)	(HEX)		(DEC)	(HEX)
100	64	Reserve	XX	XX
101	65		XX	XX
102	66		XX	XX
103	67		XX	XX
104	68		XX	XX
105	69		XX	XX
106	6A		XX	XX
107	6B		XX	XX
108	6C		XX	XX
109	6D		XX	XX
110	6E		XX	XX
111	6F	XX	XX	
112	70	PSU_CALIB_DATE "Y" = 59h	89	59
113	71	"Y" = 59h	89	59
114	72	"M" = 4Dh	77	4D
115	73	"M" = 4Dh	77	4D
116	74	"D" = 44h	68	44
117	75	"D" = 44h	68	44

## SECTION 8 MODBUS SPECIFICATIONS

The FCM10K series is compliant with the MODBUS application protocol for monitoring and control of the power supply via the RS485 communication port.

### 8.1 FCM10K Series MODBUS General Instructions

#### Equipment Setup

The following is typical RS485 MODBUS communication setup:

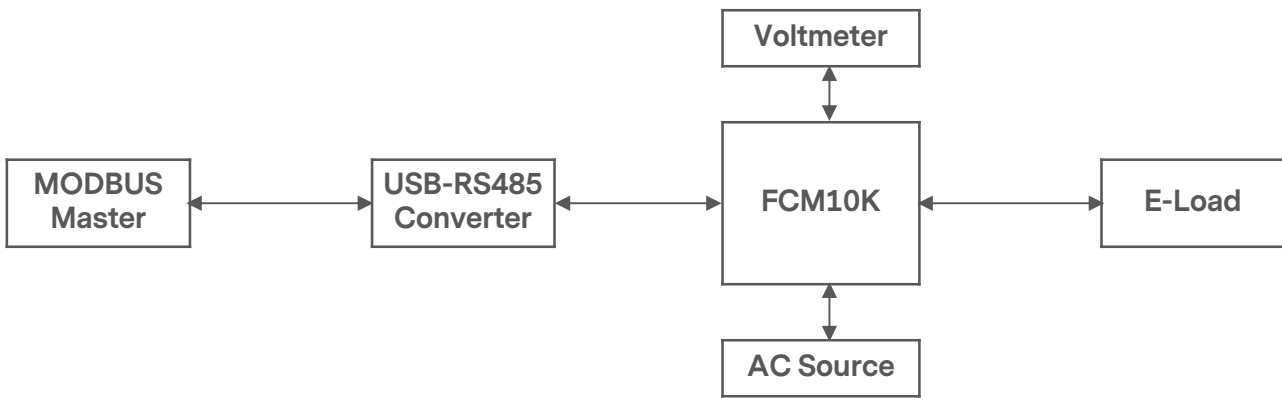

#### Serial Configuration

The Baud Rate (Data Rate) can be set by the MODBUS register (0xAB).

Parameter	Settings
Data Rate	115200 (Default)
Data Bits	8
Parity	Even
Stop Bits	1

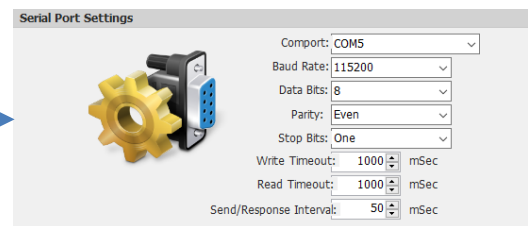

The Data Rate is configurable using the Baud Rate Config Register (0xAB).

Register Address 0xAB	
Value (Hex)	Baud Rate Configuration
0	9600
1	19200
2	38400
3	115200 (Default)



## SECTION 8 MODBUS SPECIFICATIONS

### Device Addressing

The default device base address is 0x0C and the Default Modbus Address configuration is 0xC0. Note: The 0x00 Modbus address is not supported.

Register Address 0xAA				
DEVICE_BASE_ADDRESS	RS485_ADDR2	RS485_ADDR1	RS485_ADDR0	PSU Address (Hex)
0x00	0	0	1	0x01
0x00	0	1	0	0x02
0x00	0	1	1	0x03
0x00	1	0	0	0x04
0x00	1	0	1	0x05
0x00	1	1	0	0x06
0x00	1	1	1	0x07
0x01	0	0	1	0x10
0x01	0	0	0	0x11
0x01	0	1	1	0x12
0x01	0	1	0	0x13
0x01	1	0	1	0x14
0x01	1	0	0	0x15
0x01	1	1	1	0x16
0x01	1	1	0	0x17
0x02	0	0	1	0x20
0x02	0	0	0	0x21
0x02	0	1	1	0x22
0x02	0	1	0	0x23
0x02	1	0	1	0x24
0x02	1	0	0	0x25
0x02	1	1	1	0x26
0x02	1	1	0	0x27
0x03	0	0	1	0x30
0x03	0	0	0	0x31
0x03	0	1	1	0x32
0x03	0	1	0	0x33
0x03	1	0	1	0x34
0x03	1	0	0	0x35
0x03	1	1	1	0x36
0x03	1	1	0	0x37

## SECTION 8 MODBUS SPECIFICATIONS

### Device Addressing

Register Address 0xAA				
DEVICE_BASE_ADDRESS	RS485_ADDR2	RS485_ADDR1	RS485_ADDR0	PSU Address (Hex)
...	...	...	...	...
0x0F	0	0	1	0xF0
0x0F	0	0	0	0xF1
0x0F	0	1	1	0xF2
0x0F	0	1	0	0xF3
0x0F	1	0	1	0xF4
0x0F	1	0	0	0xF5
0x0F	1	1	1	0xF6
0x0F	1	1	0	0xF7

### CRC Checking

The PSU includes an error-checking field that is based on a Cyclical Redundancy Checking (CRC) method performed on the message contents. Details are found in “MODBUS over Serial Line Specification and Implementation Guide” V1.02 document section 2.5.1.2 CRC Checking.

### Error Handling

The PSU will report MODBUS error codes if the request command is invalid. Details are found in “MODBUS over Serial Line Specification and Implementation Guide” V1.02 document section 7 MODBUS Exception Responses.

Error Code	Description
01	Illegal Function
02	Illegal Data Address
03	Illegal Data Value
04	Slave Device Failure

## SECTION 8 MODBUS SPECIFICATIONS

### Reporting Accuracy

Parameter Type	Reporting Function	Hex Address	Command Name	Accuracy Range		
				0% to 20% Load	20% to 100% Load	30% to 100% Load
Output	Output Voltage	0xB0	PSU_OUTPUT_VOLTAGE	±2%	±2%	
Output	Output Current	0xB1	PSU_OUTPUT_CURRENT	Fixed ±3% of rated max output current	±3%	
Output	Output Power	0xB2	PSU_OUTPUT_POWER	Fixed ±5% of rated max output power	±5%	
Input	Input Voltage	0xB4	PSU_INPUT_VOLTAGE_A	±5%	±5%	
Input	Input Voltage	0xD7	PSU_INPUT_VOLTAGE_B	±5%	±5%	
Input	Input Voltage	0xD8	PSU_INPUT_VOLTAGE_C	±5%	±5%	
Input	Input Current	0xB5	PSU_INPUT_CURRENT_A	Fixed ±7% of rated max input current	±15%	±10%
Input	Input Current	0xDC	PSU_INPUT_CURRENT_B	Fixed ±7% of rated max input current	±15%	±10%
Input	Input Current	0xDD	PSU_INPUT_CURRENT_C	Fixed ±7% of rated max input current	±15%	±10%
Input	Input Power	0xB6	PSU_INPUT_POWER_TOTAL	Fixed ±7% of rated max input current	±15%	±10%
Input	Input Power	0xDE	PSU_INPUT_POWER_A	Fixed ±7% of rated max input current	±15%	±10%
Input	Input Power	0xDF	PSU_INPUT_POWER_B	Fixed ±7% of rated max input current	±15%	±10%
Input	Input Power	0xE0	PSU_INPUT_POWER_C	Fixed ±7% of rated max input current	±15%	±10%
Thermal	Temperature	0xB7	PSU_TEMP1-PRI	±5°C		
Thermal	Temperature	0xB8	PSU_TEMP2- SEC	±5°C		
Thermal	Temperature	0xB9	PSU_TEMP3- BUCK	±5°C		
Thermal	Temperature	0xBA	PSU_TEMP4- AMBIENT	±5°C		
Thermal	Temperature	0xBB	PSU_TEMP5-NFC	±5°C		

## SECTION 8 MODBUS SPECIFICATIONS

### 8.2 The FCM10K Series Supported Modbus Command List

This section summarizes all Modbus Registers that are supported which can be read by either Read Holding Register (function code 03h) or Read Input Register (function code 04h), and can be write by Write Single Register (function code 06h).

Command Code	Command Name	Default Value	Access Type	Data Bytes	Data Format	Description
70h	STATUS_WORD	-	R	2	Bitmapped	Summary of the unit's fault condition
	b15 - VOUT					Asserts when any of the bit is set in STATUS_VOUT register
	b14 - IOOUT					Asserts when any of the bit is set in STATUS_IOOUT register
	b13 - INPUT					Asserts when any of the bit is set in STATUS_INPUT register
	b12 - MFR_SPECIFIC					Asserts when any of the bit is set in STATUS_MFR_SPECIFIC register
	b11- STANDBY					Asserts when any of the bit is set in STATUS_STANDBY register
	b10 - FANS					Asserts when any of the bit is set in STATUS_FAN_1_2 register
	b9:3					
	b2 - TEMPERATURE					Asserts when any of the bit is set in STATUS_TEMPERATURE register
	b1:0					
71h	STATUS_INPUT	-	R	2	Bitmapped	
	b15 - INPUT_FREQUENCY_OUT_OF_RANGE					Asserts when there is an Input line frequency out of range Auto recoverable
	b14 - INPUT_LINE_MIXED_UP_FAULT					Asserts when there is an Input line mixed up fault
	b13:8					
	b7 - VIN_OV_FAULT					Asserts when there is an input overvoltage fault auto recoverable
	B6:5					
	b4 - VIN_UV_FAULT					Asserts when there is an input under voltage fault auto recoverable
	b3					
	b2 - IIN_OC_FAULT					Asserts when there is an input overcurrent fault auto recoverable
	b1 - IIN_POWER_DERATING					Asserts when there is an input power derating auto recoverable
	b0					

## SECTION 8 MODBUS SPECIFICATIONS

The FCM10K Series Supported Modbus Command List

Command Code	Command Name	Default Value	Access Type	Data Bytes	Data Format	Description
72h	STATUS_VOUT	-	R	2	Bitmapped	
	b15 - VOUT_SC_FAULT					Asserts when there is an output short circuit fault. This can be cleared by Input power recycle
	b14:8					
	b7 - VOUT_OV_FAULT					Asserts when there is an output overvoltage fault. This can be cleared by input power recycle
	b6:5					
	b4 - VOUT_UV_FAULT					Asserts when there is an output under voltage fault at voltage source mode. This can be cleared by Input power recycle
	b3					
	b2 - TON_MAX_FAULT					Device is unable to reach the target output within the stated power up time. This Can be cleared by Input Power Recycle.
	b1:0					
73h	STATUS_IOUT	-	R	2	Bitmapped	
	b15:8					
	b7 - IOUT_OC_FAULT					Asserts when there is an Output Overcurrent Fault. This Can be cleared by Input Power Recycle.
	b6 - IOUT_OC_LV_FAULT					Asserts when there is an output overpower fault at current source mode. This can be cleared by input power recycle.
	b5:0					

## SECTION 8 MODBUS SPECIFICATIONS

The FCM10K Series Supported Modbus Command List

Command Code	Command Name	Default Value	Access Type	Data Bytes	Data Format	Description
74h	STATUS_MFR_SPECIFIC	-	R	2	Bitmapped	
	b15 - SECONDARY_RAIL_FAULT					
	b14 - BOOST_SCP					Any of the two Bulk output voltage below short circuit protection level. This can be cleared by input power recycle.
	b13 - BOOST_TON_MAX_FAULT					Device is unable to reach the target bulk voltage within the stated power up time. This can be cleared by input power recycle.
	b12 - BOOST_OVP					Bulk Voltage is above overvoltage protection level. This Can be cleared by Input Power Recycle.
	b11 - BOOST_DIFF_PROT					An event when there is a significant difference between VBulk1 and VBulk2 Regulation. This Can be cleared by Input Power Recycle.
	b10					
	b9 - BOOST_UVP					<b>Bulk voltage is below under voltage protection level. This can be cleared by Input Power Recycle.</b>
	b8 - BOOST_BAD					A Bulk voltage at nominal voltage threshold
	b7 - BOOST_OVP_NEGATIVE					Bulk Voltage on negative rail is above overvoltage protection level. This Can be cleared by Input Power Recycle.
	b6 - BOOST_OVP_POSITIVE					Bulk Voltage on positive rail is above overvoltage protection level. This Can be cleared by Input Power Recycle.
	b5					
	b4					
	b3					
	b2 - PRIMARY_OC_FAULT					Primary overcurrent fault. Latch
	b1 - SECONDARY_STUCK_ISP					The SECONDARY_STUCK_ISP is a status if secondary controller is stuck in ISP Mode.
	b0 - PRIMARY_STUCK_ISP					The PRIMARY_STUCK_ISP is a status if primary controller is stuck in ISP Mode.

## SECTION 8 MODBUS SPECIFICATIONS

The FCM10K Series Supported Modbus Command List

Command Code	Command Name	Default Value	Access Type	Data Bytes	Data Format	Description
76h	STATUS_TEMPERATURE	-	R	2	Bitmapped	
	b15 - BOOST_LLC_OT_FAULT					Primary boost temperature is above over temperature fault limit. Auto recoverable.
	b14 - BOOST_PFC_OT_FAULT					Primary boost temperature is above over temperature fault limit. Auto recoverable.
	b13 - DCDC_OR_OT_FAULT					Secondary DCDC Oring temperature is above over temperature fault limit. Auto recoverable.
	b12 - DCDC_SYNC_A_OT_FAULT					Secondary DCDC SYNC_A temperature is above over temperature fault limit. Auto recoverable.
	b11 - DCDC_SYNC_B_OT_FAULT					Secondary DCDC SYNC_B temperature is above over temperature fault limit. Auto recoverable.
	b10 - DCDC_SYNC_C_OT_FAULT					Secondary DCDC SYNC_C temperature is above over temperature fault limit. Auto recoverable.
	b9 - AMBIENT_OT_FAULT					Logic ambient temperature is above over temperature fault limit. Auto recoverable
	b8					
	b7 - OT_FAULT					Asserts when any of the bit [15:9] in STATUS_TEMPERATURE register is set. Auto recoverable.
B6:0						
77h	STATUS_FANS_1_2	-	R	2	Bitmapped	Report the status of any fans installed in position 1 or position 2.
	b15:8					
	b7 - FAN_1_FAULT					Fan 1 failed completely or not able to provide the target RPM to cool the device. Auto recoverable.
	b6 - FAN_2_FAULT					Fan 2 failed completely or not able to provide the target RPM to cool the device. Auto recoverable.
	B5:4					
	b3 - FAN_1_SPEED_OVERRIDDEN					
	b2 - FAN_2_SPEED_OVERRIDDEN					
	B1:0					

## SECTION 8 MODBUS SPECIFICATIONS

The FCM10K Series Supported Modbus Command List

Command Code	Command Name	Default Value	Access Type	Data Bytes	Data Format	Description
7Ch	STATUS_STANDBY	-	R	2	Bitmapped	
	b15:5					
	b4 - STANDBY_SC_FAULT					Standby voltage is below short circuit voltage protection level and standby output is over current protection level. This can be cleared by input power recycle.
	b3 - STANDBY_VOUT_OV_FAULT					Standby voltage is above over voltage protection level. This can be cleared by input power recycle.
	b2 - STANDBY_VOUT_UV_FAULT					Standby voltage is below under voltage protection level. This can be cleared by input power recycle.
	b1 - STANDBY_IOUT_OC_FAULT					Standby output is above over current protection level. This can be cleared by input power recycle.
	b0 - STANDBY_VOUT_BAD					Standby output is below nominal voltage threshold
84h	OPERATION	0080	R/W	2		Used to turn the device on and off.
	b15:9					
	b8 - CLEAR_FAULT_LATCH					0 - Do nothing 1 - Clear all latching faults
	b7 - ON					0 - PSU Off 1 - PSU On
87h	MODULE_CONFIG	-	R/W	2		Used to configure the module.
	b15:4					
	b3 - OPERATION MODE					0 - Voltage Source Mode 1 - Current Source Mode
	b2					
	b1 - REMOTE MODE					0 - Digital Mode 1 - Analog Mode
88h	MODULE_OPERATION	-	R/W	2		Used to enable/disable the module configuration.
	b15:2					
	b1 - Module Sync Start Override					0- Disable override for sync start (Do Sync) 1- Enable override for sync start (Not ready for Sync)
	b0 - Enable Module Configuration					0 - Disable Configuration (This will turn on the PSU) 1 - Enable Configuration (This will turn off the PSU)



## SECTION 8 MODBUS SPECIFICATIONS

The FCM10K Series Supported Modbus Command List

Command Code	Command Name	Default Value	Access Type	Size in Word	Data Format	Description
00h	PSU_MODEL_ID	-	R	2	ASCII	Varies
02h	PSU_MFR_MODEL	-	R	10	ASCII	Varies
0Ch	PSU_MFR_LOCATION	-	R	10	ASCII	Default: "LAGUNA"
16h	PSU_MFR_DATE	-	R	4	ASCII	Format: "WW/YYYY"
1Ah	PSU_MFR_SERIAL	-	R	10	ASCII	Format: "SSSSS"
24h	PSU_HW_REVISION	-	R	2	ASCII	Format: "ZZZ"
26h	PSU_FW_REVISION	-	R	12	ASCII	Varies
38h	PSU_CALIB_DATE	-	R	3	ASCII	Format: "YYMMDD"
3Bh to 6Fh	RESERVED FOR MFR SPECIFIC RELATED COMMANDS					
70h	STATUS_WORD	-	R	1	Bitmapped	
71h	STATUS_INPUT	-	R	1	Bitmapped	
72h	STATUS_VOUT	-	R	1	Bitmapped	
73h	STATUS_IOUT	-	R	1	Bitmapped	
74h	STATUS_MFR_SPECIFIC	-	R	1	Bitmapped	
75h	RESERVED FOR STATUS MONITORING COMMANDS					
76h	STATUS_TEMPERATURE	-	R	1	Bitmapped	
77h	STATUS_FAN_1_2	-	R	1	Bitmapped	
78h to 7Bh	RESERVED FOR STATUS MONITORING COMMANDS					
7Ch	STATUS_STANDBY	-	R	1	Bitmapped	
7Dh to 7Fh	RESERVED FOR CONFIGURABLE RELATED COMMANDS					
80h to 81h	RESERVED FOR CONFIGURABLE RELATED COMMANDS					
82h	FAN1 RPM OVERRIDE	0%	R/W	1	x1	Range: 0% to 100%
84h	OPERATION	0x0080	R/W	1	Bitmapped	-
85h	VREF_TRIM	54.5	R/W	1	x100	Range: 48.0V to 60.0V (VREF_MAX_LIMIT)
86h <sup>1</sup>	IREF_TRIM	-	R/W	1	x100	Voltage Source Mode: Default: 183.5A Range: 9.175A to 183.5A (IREF_MAX_LIMIT) Current Source Mode: Default 9.175A Range: 9.175A to 183.5A (IREF_MAX_LIMIT)
87h	MODULE CONFIG	-	R/W	1	Bitmapped	-
88h	MODULE OPERATION	-	R/W	1	Bitmapped	-
89h to 8Ah	RESERVED FOR CONFIGURABLE RELATED COMMANDS					
8Bh	DSP_PROG_RESCALE_PROFILE	-	R/W	1	-	Default: 0x00 - Default Profile 0x01 - (Profile 1) 0x02 - (Profile 2) 0x03 - (Profile 3)
8Ch	VPROG_RESCALE_MIN	48	R/W	1	x100	Range: 48V to 60V
8Dh	VPROG_RESCALE_MAX	60	R/W	1	x100	Range: VPROG_RESCALE_MIN to 60V
8Eh	VPROG_RESCALE_PT1	1	R/W	1	x100	Range: VPROG_TURN_ON_POINT to 10V
8Fh	VPROG_RESCALE_PT2	10	R/W	1	x100	Range: VPROG_RESCALE_PT1 to 10V

Note 1 - Applicable for wide trim Variant.

## SECTION 8 MODBUS SPECIFICATIONS

The FCM10K Series Supported Modbus Command List

Command Code	Command Name	Default Value	Access Type	Size in Word	Data Format	Description
90h	VPROG_TURN_ON_POINT	0.48	R/W	1	x100	Range: 0.48V to 10V
91h <sup>1</sup>	IPROG_RESCALE_MIN	0.48	R/W	1	x100	Range: 0.48A to 183.5A
92h <sup>1</sup>	IPROG_RESCALE_MAX	183.5	R/W	1	x100	Range: IPROG_RESCALE_MIN to 183.5A
93h <sup>1</sup>	IPROG_RESCALE_PT1	1	R/W	1	x100	Range: IPROG_TURN_ON_POINT to 10V
94h <sup>1</sup>	IPROG_RESCALE_PT2	10	R/W	1	x100	Range: IPROG_RESCALE_PT2 to 10V
95h <sup>1</sup>	IPROG_TURN_ON_POINT	0.48	R/W	1	x100	Range: 0.48V to 10V
96h	IO_POLARITY	-	R/W	1	-	Default: 0x01 - Disabled Standalone Mode 0x02 - Enable Standalone Mode Range: 0x00 to 0x03
97h <sup>1</sup>	VREF_MAX_LIMIT	60	R/W	1	x100	Range: 48V to 60V (Auto save in Non Volatile Memory after Writing)
98h <sup>1</sup>	IREF_MAX_LIMIT	-	R/W	1	x100	Range: 0.48A to 183.5A (Auto save in Non Volatile Memory after Writing)
99h to A9h	RESERVED FOR CONFIGURABLE RELATED COMMANDS					
AAh	DEVICE_BASE_ADDRESS	0x0C	R/W	1	-	0x00 – 0x0F
ABh	BAUD_RATE_CONFIG	-	R/W	1	-	
ACh to AFh	RESERVED FOR CONFIGURABLE RELATED COMMANDS					
B0h	PSU_OUTPUT_VOLTAGE	-	R	1	x100	Varies
B1h	PSU_OUTPUT_CURRENT	-	R	1	x100	Varies
B2h	PSU_OUTPUT_POWER	-	R	1	x1	Varies
B3h	PSU_OUTPUT_VOR_VOLTAGE	-	R	1	x10	Varies
B4h	PSU_INPUT_VOLTAGE_A	-	R	1	x100	Varies
B5h	PSU_INPUT_CURRENT_A	-	R	1	x100	Varies
B6h	PSU_INPUT_POWER	-	R	1	x1	Varies
B7h	PSU_TEMP1-PRI	-	R	1	x100	Varies
B8h	PSU_TEMP2- SEC	-	R	1	x100	Varies
B9h <sup>1</sup>	PSU_TEMP3- BUCK	-	R	1	x100	Varies
BAh	PSU_TEMP4- AMBIENT	-	R	1	x100	Varies
BBh	PSU_TEMP5-NFC	-	R	1	x100	Varies
BCh to BDh	RESERVED FOR MONITORING RELATED COMMANDS					
BEh	PSU RPM FAN0	-	R	1	x1	Varies
BFh	PSU RPM FAN1	-	R	1	x1	Varies
C0h to D4h	RESERVED FOR MONITORING RELATED COMMAND					
D5h	PSU_STANDBY_VOLTAGE	-	R	1	x100	Varies
D6h	PSU_STANDBY_CURRENT	-	R	1	x10000	Varies
D7h	PSU_INPUT_VOLTAGE_B	-	R	1	x1	Varies
D8h	PSU_INPUT_VOLTAGE_C	-	R	1	x1	Varies
D9h to DBh	RESERVED FOR MONITORING RELATED COMMANDS					

Note 1 - Applicable for wide trim Variant.

## SECTION 8 MODBUS SPECIFICATIONS

The FCM10K Series Supported Modbus Command List

Command Code	Command Name	Default Value	Access Type	Size in Word	Data Format	Description
DCh	PSU_INPUT_CURRENT_B	-	R	1	x100	Varies
DDh	PSU_INPUT_CURRENT_C	-	R	1	x100	Varies
DEh	PSU_INPUT_POWER_A	-	R	1	x1	Varies
DFh	PSU_INPUT_POWER_B	-	R	1	x1	Varies
E0h	PSU_INPUT_POWER_C	-	R	1	x1	Varies
E1h	PSU_INPUT_LINE_FREQ	-	R	1	x10	Varies
E2h to FFh	RESERVED FOR MONITORING RELATED COMMANDS					
600h	BLACKBOX_PAGE	0	R	1	-	Value: 0-9
610h	FAULT_RECORD_STATUS_WORD	-	R	1	Bitmapped	Varies
611h	FAULT_RECORD_STATUS_INPUT	-	R	1	Bitmapped	Varies
612h	FAULT_RECORD_STATUS_VOUT	-	R	1	Bitmapped	Varies
613h	FAULT_RECORD_STATUS_IOUT	-	R	1	Bitmapped	Varies
614h	FAULT_RECORD_STATUS_MFR_SPECIFIC	-	R	1	Bitmapped	Varies
615h	FAULT_RECORD_STATUS_STANDBY	-	R	1	Bitmapped	Varies
616h	FAULT_RECORD_STATUS_TEMPERATURE	-	R	1	Bitmapped	Varies
617h	FAULT_RECORD_STATUS_FAN_1_2	-	R	1	Bitmapped	Varies
618h	FAULT_RECORD_PSU_OUTPUT_VOLTAGE	-	R	1	x100	Varies
619h	FAULT_RECORD_PSU_OUTPUT_CURRENT	-	R	1	x100	Varies
61Ah	FAULT_RECORD_PSU_OUTPUT_POWER	-	R	1	x1	Varies
61Bh	FAULT_RECORD_PSU_OUTPUT_VOLTAGE	-	R	1	x100	Varies
61Ch	FAULT_RECORD_PSU_INPUT_VOLTAGE_A	-	R	1	x1	Varies
61Dh	FAULT_RECORD_PSU_INPUT_CURRENT_A	-	R	1	x100	Varies
61Eh	FAULT_RECORD_PSU_INPUT_VOLTAGE_B	-	R	1	x1	Varies
61Fh	FAULT_RECORD_PSU_INPUT_CURRENT_B	-	R	1	x100	Varies
620h	FAULT_RECORD_PSU_INPUT_VOLTAGE_C	-	R	1	x1	Varies
621h	FAULT_RECORD_PSU_INPUT_CURRENT_C	-	R	1	x100	Varies
622h	FAULT_RECORD_PSU_INPUT_POWER_TOTAL	-	R	1	x1	Varies
623h	FAULT_RECORD_TEMP1-PRI	-	R	1	x100	Varies
624h	FAULT_RECORD_TEMP2-SEC	-	R	1	x100	Varies

## SECTION 8 MODBUS SPECIFICATIONS

The FCM10K Series Supported Modbus Command List

Command Code	Command Name	Default Value	Access Type	Size in Word	Data Format	Description
625h	FAULT_RECORD_TEMP3-BUCK	-	R	1	x100	Varies
626h	FAULT_RECORD_TEMP4-AMBIENT	-	R	1	x100	Varies
627h	FAULT_RECORD_TEMP5-NFC	-	R	1	x100	Varies
628h	FAULT_RECORD_PSU_FAN1	-	R	1	x100	Varies
629h	FAULT_RECORD_PSU_FAN2	-	R	1	x100	Varies
62Ah	FAULT_RECORD_PSU_STANDBY_VOLTAGE	-	R	1	x100	Varies
62Bh	FAULT_RECORD_PSU_STANDBY_CURRENT	-	R	1	x10000	Varies
62Ch	FAULT_RECORD_PSU_MODULE_CONFIG	-	R	1	Bitmapped	Varies
62Dh	FAULT_RECORD_PSU_VREF_TRIM	-	R	1	x100	Varies
62Eh	FAULT_RECORD_PSU_IREF_TRIM	-	R	1	x100	Varies
62Fh	FAULT_RECORD_PSU_BAUD_RATE_CONFIG	-	R	1	-	Varies
630h	FAULT_RECORD_PSU_VREF_MAX_LIMIT	-	R	1	x100	Varies
631h	FAULT_RECORD_PSU_IREF_MAX_LIMIT	-	R	1	x100	Varies
632h	FAULT_RECORD_PSU_PRI_ADPUART_ERROR_COUNT	-	R	1	x1	Varies
633h	FAULT_RECORD_PSU_SEC_PRI_ADPUART_ERROR_COUNT	-	R	1	x1	Varies
634h	FAULT_RECORD_PSU_SEC_LOGIC_ADPUART_ERROR_COUNT	-	R	1	x1	Varies
635h	FAULT_RECORD_PSU_LOGIC_ADPUART_ERROR_COUNT	-	R	1	x1	Varies
636h	FAULT_RECORD_PSU_TOTAL_TIME	-	R	2	-	Varies
638h	FAULT_RECORD_PSU_TIME_SINCE_LAST_ON	-	R	2	-	Varies
63Ah	FAULT_RECORD_HIGH_AMBIENT_TIMER	-	R	2	-	Varies
63Ch	FAULT_RECORD_VOR_LLC_OVP	-	R	1	x100	Varies
63Dh	FAULT_RECORD_PSU_INPUT_POWER_A	-	R	1	x1	Varies
63Eh	FAULT_RECORD_PSU_INPUT_POWER_B	-	R	1	x1	Varies
63Fh	FAULT_RECORD_PSU_INPUT_POWER_C	-	R	1	x1	Varies
640h	FAULT_RECORD_Ambient Temp I2C Error Count	-	R	1	x1	Varies

## SECTION 8 MODBUS SPECIFICATIONS

The FCM10K Series Supported Modbus Command List

Command Code	Command Name	Default Value	Access Type	Size in Word	Data Format	Description
641h	FAULT_RECORD_NFC I2C Error Count	-	R	1	x1	Varies
642h to 6HHh	RESERVED FOR FAULT RECORD RELATED COMMANDS					

## SECTION 9 APPLICATION NOTES

### 9.1 Mode of Operation

The power supply is configurable between voltage source and current source. At voltage source mode, the output voltage is kept regulated at different line, load, operating temperature, and any other conditions (as long as it is within the normal operating range). At current source mode, the output current is the one to be kept within regulation level.

### 9.2 Digital and Analog Command

The output of the power supply is remotely programmable, only one programming method is allowed at a time. The default Output Voltage and Current trimming is through digital command via Modbus.

Methods for Output Adjustment	
Voltage Source	Digital Command via RS485 ModBus Analog via CC/CV_MODE input signal pin <ul style="list-style-type: none"> <li>• Adjustment of Vout through external voltage on V_prog output signal</li> <li>• 0-10V Remote Programming on V_PROG output signal</li> </ul>
Current Source	Digital Command via RS485 ModBus Analog via CC/CV_MODE input signal pin <ul style="list-style-type: none"> <li>• Adjustment of Vout through external voltage on V_prog output signal</li> <li>• 0-10V Remote Programming on I_PROG output signal</li> </ul>
Digital Command to Analog	Digital Command via RS485 ModBus ANALOG/DIGITAL_MODE signal Pin out <ul style="list-style-type: none"> <li>• Pulled to GNDL will enable Vout and Iout trimming via analog (CC/CV_MODE)</li> <li>• OPEN will enable Vout and Iout trimming via digital command</li> </ul>

## SECTION 9 APPLICATION NOTES

### 9.3 Output Adjustability and Programmability

#### Output Adjusted via RS485 ModBus Communication Commands

Applicable for both Voltage Source and Current Source mode operation.

#### 0-10V Remote Programming (V\_PROG and I\_PROG)

Applicable for both voltage source and current Source mode operation. The table below is for reference only.

##### Output Voltage adjustment via V\_PROG pin

0-10V_PROG (V)	Output Voltage (V)
0	48
1	49.2
2	50.4
3	51.6
4	52.8
5	54
6	55.2
7	56.4
8	57.6
9	58.8
10	60

##### Output Voltage adjustment via I\_PROG pin

0-10V_PROG (V)	Output Current (A)
0	TBA
1	TBA
2	TBA
3	TBA
4	TBA
5	TBA
6	TBA
7	TBA
8	TBA
9	TBA
10	TBA

## SECTION 9 APPLICATION NOTES

### 0-10V re-scaling function (VPROG / IPROG RESCALING)

This section describes the Analog Vprog and Iprog Rescaling function of the PSU (See under Output Adjustability and Programmability, 0-10V re-scaling function section of the Product Specification) and corresponding rescale profiles.

Note: Vprog or Iprog rescaling is only available for Wide trim Range Variant PSU.

#### Vprog Rescaling

The PSU's mode of operation must be on analog Voltage Source mode when MODULE\_CONFIG (command code 87h) is set to 02h.

Note: The PSU should be on standby mode when adjusting Vprog rescale profile.

#### Vprog Rescaling Default Profile

This describes the setting for analog Vprog default profile. Writing 00h (default) to DSP\_PROG\_RESCALE\_PROFILE (command code 8Bh) will update the Vprog profile to default. This profile will set target voltage to TBA V to TBA V for 0V to 10V Vprog respectively.

PSU target voltage versus the 0-10V Vprog for Vprog rescale default profile.

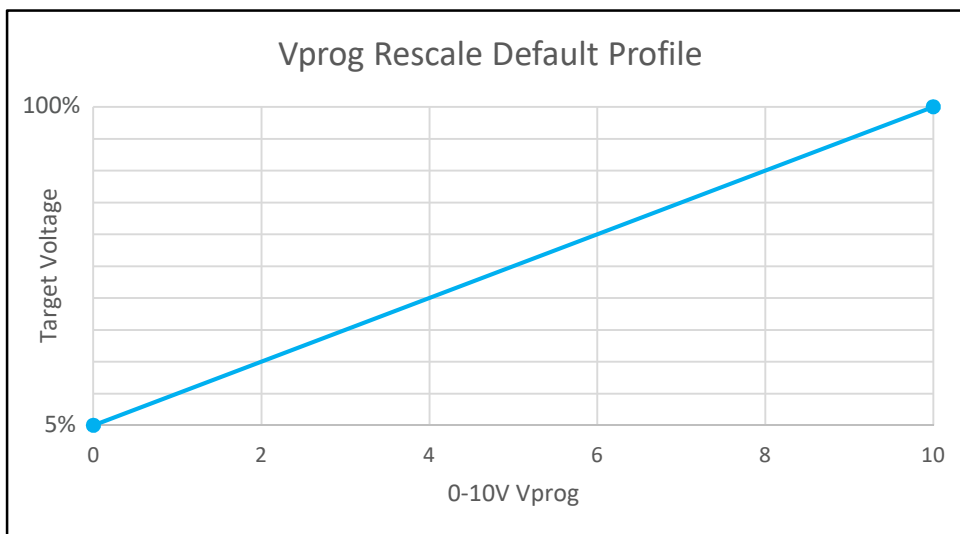



## SECTION 9 APPLICATION NOTES

### VPROG Rescaling Profile 1

The following sequence of commands should be followed to set Vprog Profile 1:

1. Set VPROG\_RESCALE\_MIN (command code 8Ch) to adjust the minimum rescale value.
2. Set VPROG\_RESCALE\_MAX (command code 8Fh) to adjust to adjust the maximum rescale value.
3. Set DSP\_PROG\_RESCALE\_PROFILE (command code 8Bh) to 01h (profile 1) to update the Vprog profile based on the written values from the rescale commands.

Sample Vprog rescale profile 1 adjustment is shown below, VPROG\_RESCALE\_MIN is set to 14000 (140V), and VPROG\_RESCALE\_MAX is set to 20000 (200V).

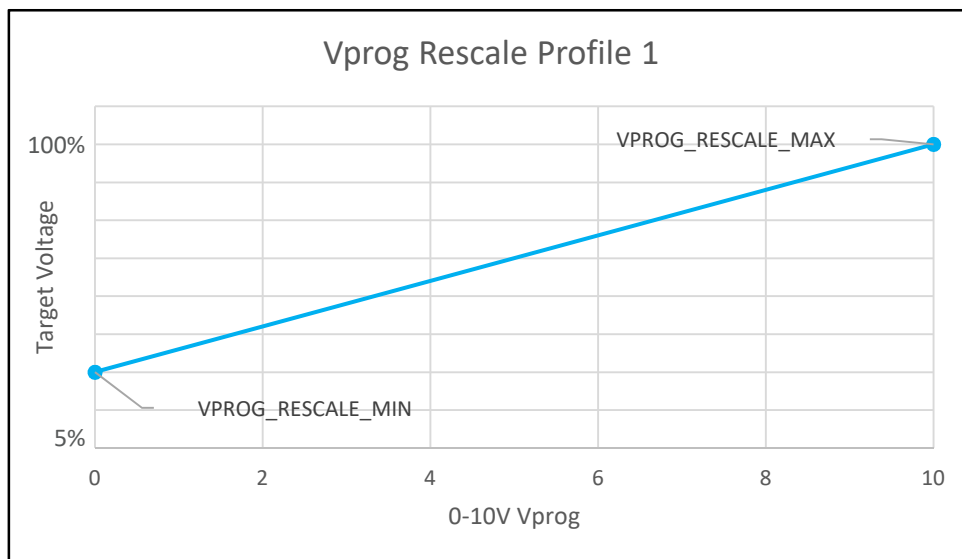

Note: VPROG\_RESCALE\_MIN must be less than VPROG\_RESCALE\_MAX.

## SECTION 9 APPLICATION NOTES

### Vprog Rescaling Profile 2

The following sequence of commands should be followed to set Vprog Profile 2:

1. Set VPROG\_RESCALE\_PT1 (command code 8Eh) to adjust the Vprog Low Point.
2. Set VPROG\_RESCALE\_PT2 (command code 8Fh) to adjust the Vprog High Point.
3. Set DSP\_PROG\_RESCALE\_PROFILE (command code 8Bh) to 02h (profile 2) to update the Vprog profile based on the written values from the rescale commands.

Sample Vprog rescale profile 2 adjustment is shown below, VPROG\_RESCALE\_PT1 is set to 200 (2V), and VPROG\_RESCALE\_PT2 is set to 500 (5V).

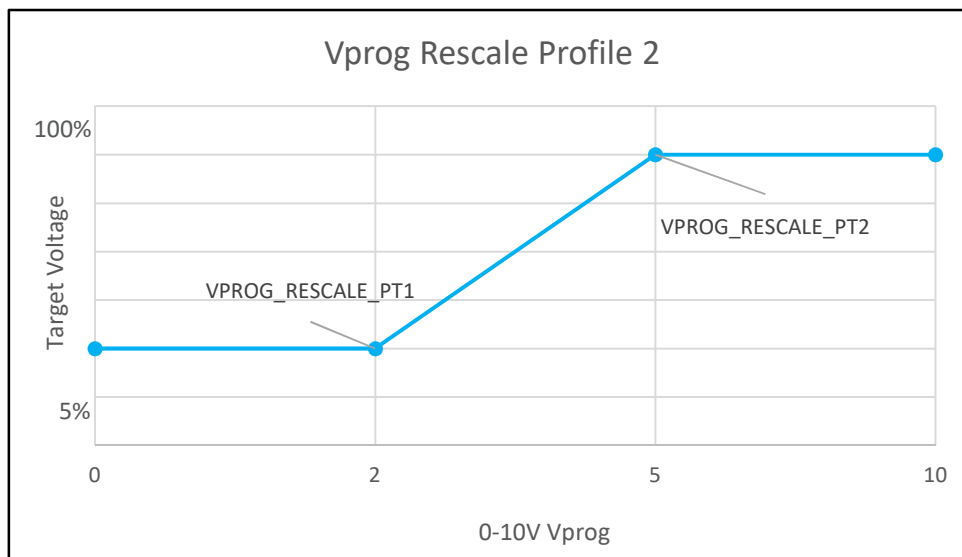

Note: VPROG\_RESCALE\_PT1 must be less than VPROG\_RESCALE\_PT2.

## SECTION 9 APPLICATION NOTES

### Vprog Rescaling Profile 3

The following sequence of commands should be followed to set Vprog Profile 3:

1. Set VPROG\_TURN\_ON\_POINT (command code 90h) to adjust Vprog Turn on Point.
2. Set VPROG\_RESCALE\_PT1 (command code 8Eh) to adjust the Vprog Low Point.
3. Set VPROG\_RESCALE\_PT2 (command code 8Fh) to adjust the Vprog High Point.
4. Set DSP\_PROG\_RESCALE\_PROFILE (command code 8Bh) to 03h (profile 3) to update the Vprog profile based on the written values from the rescale commands.

Sample Vprog rescale profile 3 adjustment is shown below, VPROG\_TURN\_ON\_POINT is set to 50 (0.5V), VPROG\_RESCALE\_PT1 is set to 200 (2V), and VPROG\_RESCALE\_PT2 is set to 500 (5V).

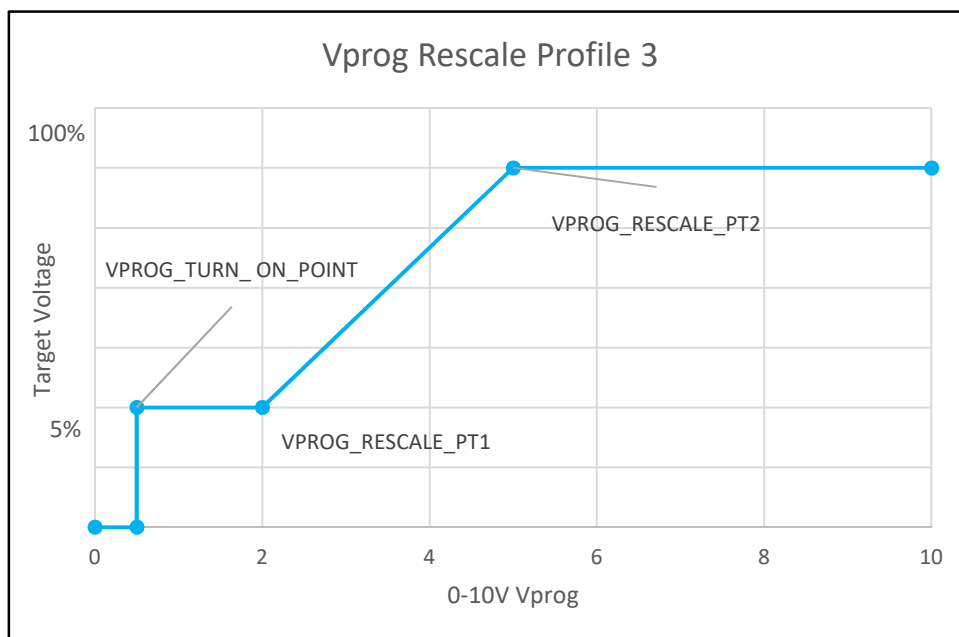

Note: VPROG\_TURN\_ON\_POINT must be less than VPROG\_RESCALE\_PT1, and VPROG\_RESCALE\_PT1 must be less than VPROG\_RESCALE\_PT2.

## SECTION 9 APPLICATION NOTES

### Iprog Rescaling

The PSU's mode of operation must be on analog Current Source mode when MODULE\_CONFIG (command code 87h) is set to 0Ah. The PSU should be on standby mode when adjusting Iprog rescale profile.

### Iprog Rescaling Default Profile

This describes the setting for analog Iprog default profile. Writing 00h (default) to DSP\_PROG\_RESCALE\_PROFILE (command code 8Bh) will update the Iprog profile to default. This profile will set target current to 0.48-16A for 0-10V Iprog respectively.

PSU target Current versus the 0-10V Iprog for Iprog rescale default profile.

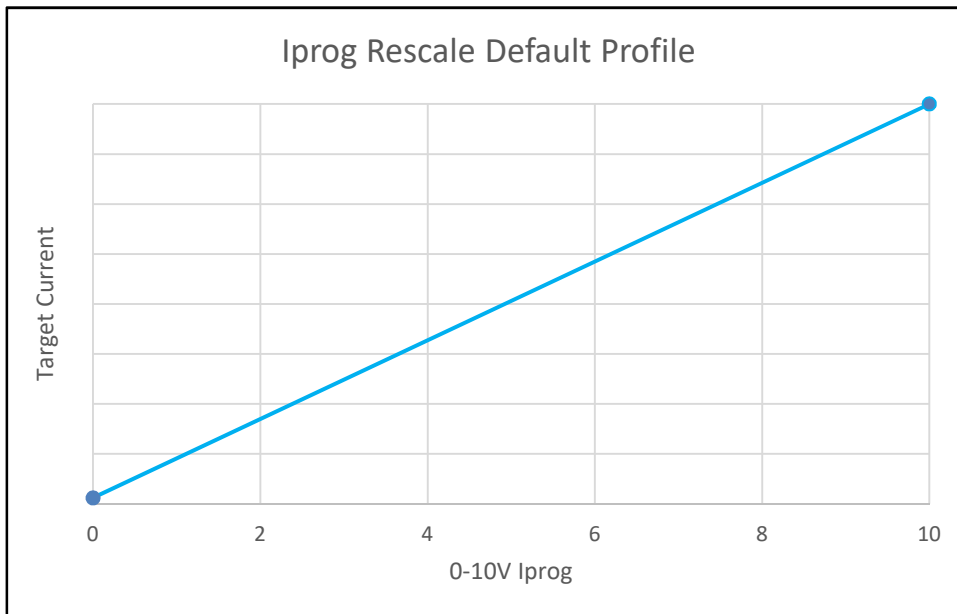

## SECTION 9 APPLICATION NOTES

### Iprog Rescaling Profile 1

The following sequence of commands should be followed to set Iprog Profile 1:

1. Set IPROG\_RESCALE\_MIN (command code 91h) to adjust the minimum rescale value.
2. Set IPROG\_RESCALE\_MAX (command code 92h) to adjust to adjust the maximum rescale value.
3. Set DSP\_PROG\_RESCALE\_PROFILE (command code 8Bh) to 01h (profile 1) to update the Iprog profile based on the written values from the rescale commands.

Sample Iprog rescale profile 1 adjustment is shown below, IPROG\_RESCALE\_MIN is set to 300 (3A), and IPROG\_RESCALE\_MAX is set to 1440 (14.4A).

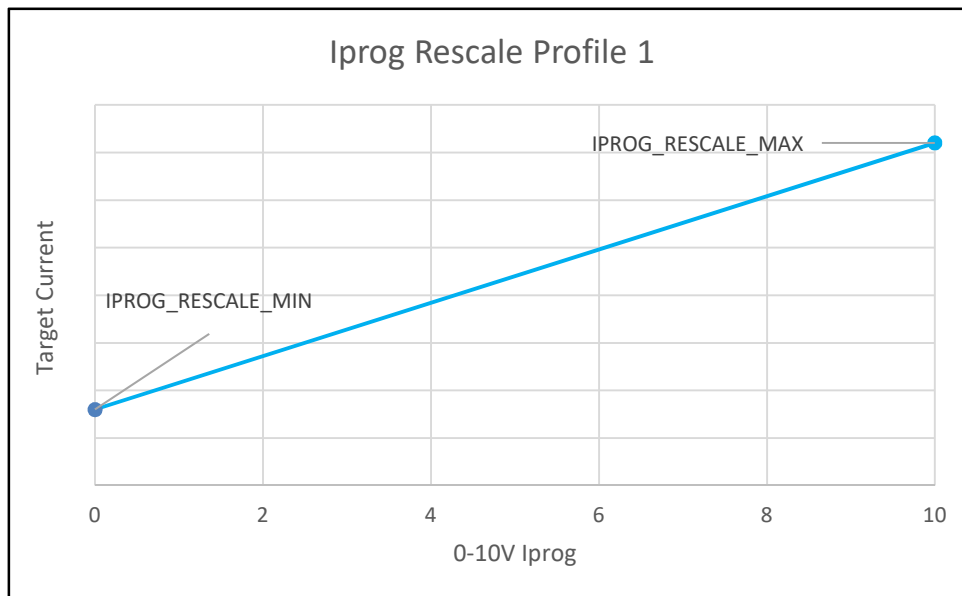

Note: IPROG\_RESCALE\_MIN must be less than IPROG\_RESCALE\_MAX.

## SECTION 9 APPLICATION NOTES

### Iprog Rescaling Profile 2

The following sequence of commands should be followed to set Iprog Profile 2:

1. Set IPROG\_RESCALE\_PT1 (command code 93h) to adjust the Iprog Low Point.
2. Set IPROG\_RESCALE\_PT2 (command code 94h) to adjust the Iprog High Point.
3. Set DSP\_PROG\_RESCALE\_PROFILE (command code 8Bh) to 02h (profile 2) to update the Iprog profile based on the written values from the rescale commands.

Sample Iprog rescale profile 2 adjustment is shown below, IPROG\_RESCALE\_PT1 is set to 200 (2V), and IPROG\_RESCALE\_PT2 is set to 900 (9V).

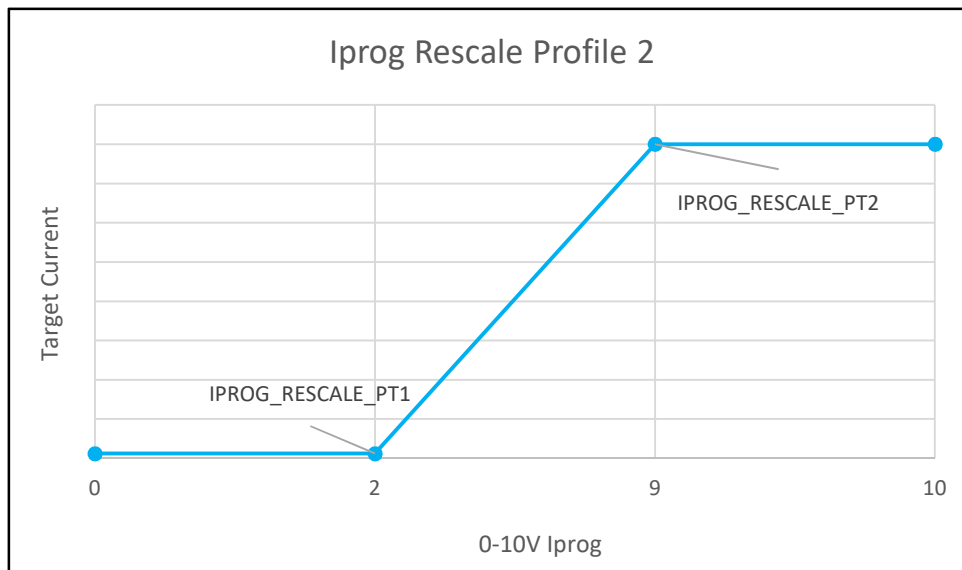

Note: IPROG\_RESCALE\_PT1 must be less than IPROG\_RESCALE\_PT2.

## SECTION 9 APPLICATION NOTES

### Iprog Rescaling Profile 3

The following sequence of commands should be followed to set Vprog Profile 3:

1. Set IPROG\_TURN\_ON\_POINT (command Code 95h) to adjust Iprog Turn on Point.
2. Set IPROG\_RESCALE\_PT1 (command code 93h) to adjust the Iprog Low Point.
3. Set IPROG\_RESCALE\_PT2 (command code 94h) to adjust the Iprog High Point.
4. Set DSP\_PROG\_RESCALE\_PROFILE (command code 8Bh) to 03h (profile 3) to update the Iprog profile based on the written values from the rescale commands.

Sample Iprog rescale profile 3 adjustment is shown below, IPROG\_TURN\_ON\_POINT is set to 100 (1V), IPROG\_RESCALE\_PT1 is set to 200 (2V), and IPROG\_RESCALE\_PT2 is set to 500 (5V).

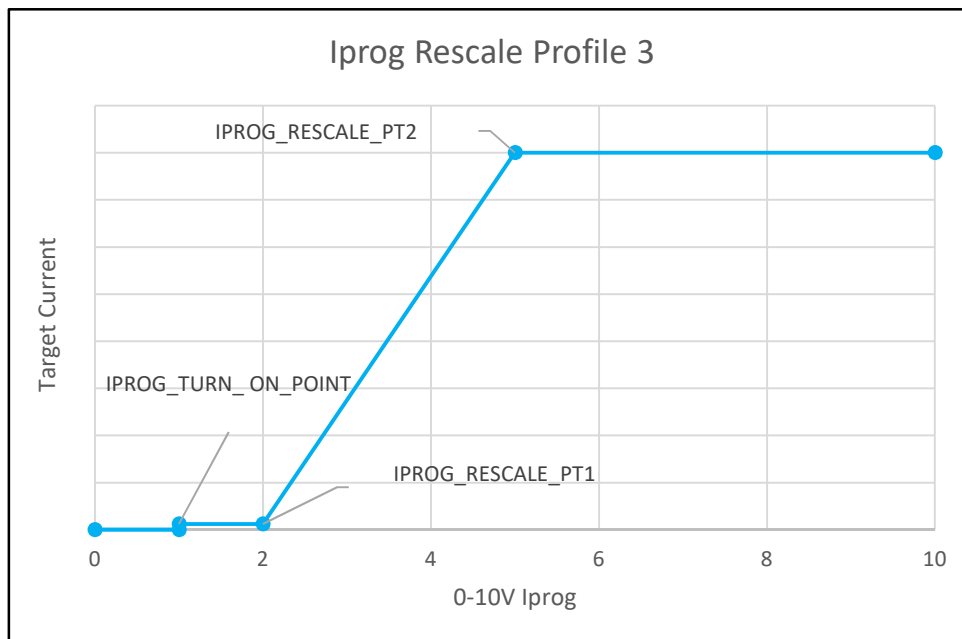

Note: IPROG\_TURN\_ON\_POINT must be less than IPROG\_RESCALE\_PT1, and IPROG\_RESCALE\_PT1 must be less than IPROG\_RESCALE\_PT2.

## SECTION 9 APPLICATION NOTES

### 9.4 Current Sharing

The FCM10K series shall have a dedicated analog bus for active current sharing. The PSU input impedance of the current sharing shall be 30kR & 100pF or better. Current sharing bus (Ishare) full-scale voltage shall be 7V at full load.

The PSU will have an active load sharing percentage as shown below.

Rail Loading (%)	Sharing Percent Error(%)
25%	±10%
50%	±5%
75%	±4%
100%	±4%

Percent Error =  $ABS (PSU_n - \text{Average Current}) / (\text{Average Current})$

$PSU_n$  – Current delivered by  $PSU_n$

Average Current =  $(PSU_1 + PSU_2 + PSU_3 + \dots + PSU_6) / (\text{number of PSU in parallel})$



## SECTION 9 APPLICATION NOTES

### 9.5 Output Ripple and Noise Measurement

The setup outlined in the diagram below has been used for output ripple and noise measurements on the FCM10K series (Voltage Source Mode). When measuring output ripple and noise, a scope jack in parallel with a 0.1 $\mu$ F ceramic chip capacitor, and a 10 $\mu$ F tantalum capacitor should be used. oscilloscope should be set to 20MHz bandwidth for this measurement.

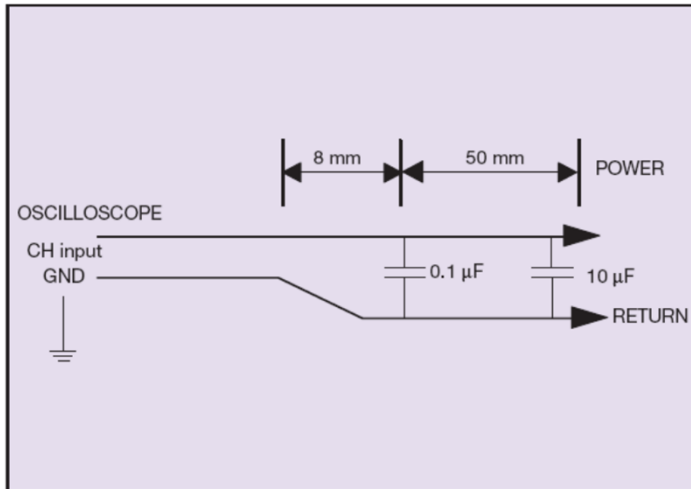

SECTION 9 APPLICATION NOTES

9.6 Accessories

Kit-1 FCM10K-P Test Kits: 83-788-001

Orderable Part Number	Description	Diagram
750-018626-0000	Input Mating Connector	<p>The diagram shows a side view of a black rectangular connector with a vertical row of pins on the left. A label 'PIN 1' points to the first pin. A top view shows a black PCB with three wires (red, blue, green) extending from it. Dimensions include a total length of <math>4.00 \pm 10</math> mm, a 30 mm distance from the PCB edge to the start of the wires, and a 30 mm distance between the wires. Components are labeled as HTSH107 (L=30mm) and HTSH109 (L=80mm).</p>
750-018627-0000	6-way Connector (Non-isolated Signal)	<p>The diagram shows a top view of a yellow 6-way connector with six colored wires (yellow, purple, green, blue, red, black). A label 'PIN 1' points to the first pin. The total length of the cable is 420 mm. The distance from the connector to the start of the wires is 100 mm, and the distance from the end of the wires to the other connector is also 100 mm. The component is labeled as OTHR209.</p>
750-018627-0000	20-way Mating Connector (Isolated Signal)	<p>The diagram shows a top view of a 20-way mating connector with two 10-pin connectors (J301 and J302) connected by a black cable (CBLD300). The total length of the cable is <math>4.00 \pm 10</math> mm. The distance from each connector to the center of the cable is 4.0 mm. A label 'PIN 1' points to the first pin on connector J301.</p>

## SECTION 9 APPLICATION NOTES

### 9.6 Accessories

Kit-2 FCM10K DC Back Plane Test Kits: 83-788-002

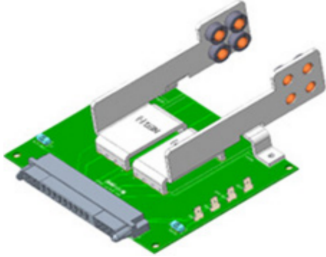
Orderable Part Number	Description	Diagram
790-026751-0000	Single DCDC Back Plane	

Kit-3 FCM10K-T Test Kits: 83-788-003

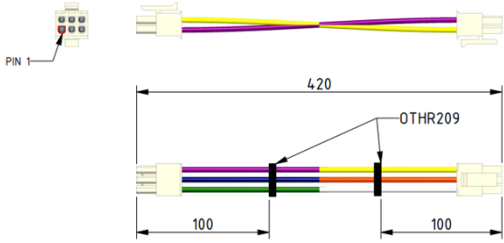
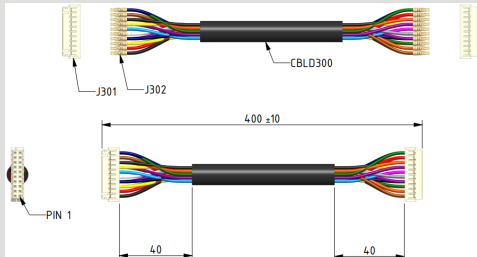
Orderable Part Number	Description	Diagram
750-018627-0000	6-way Connector (Non-isolated Signal)	
750-018627-0000	20-way Mating Connector (Isolated Signal)	

**SECTION 10 RECORD OF REVISION AND CHANGES**

Issue	Date	Description	Originators
1.0	02.08.24	First Issue	Z. Yasheng



For international contact information,  
visit [advancedenergy.com](http://advancedenergy.com).

[powersales@aei.com](mailto:powersales@aei.com) (Sales Support)  
[productsupport.ep@aei.com](mailto:productsupport.ep@aei.com) (Technical Support)  
+1 888 412 7832

## ABOUT ADVANCED ENERGY

Advanced Energy (AE) has devoted more than four decades to perfecting power for its global customers. AE designs and manufactures highly engineered, precision power conversion, measurement and control solutions for mission-critical applications and processes.

Our products enable customer innovation in complex applications for a wide range of industries including semiconductor equipment, industrial, manufacturing, telecommunications, data center computing, and medical. With deep applications know-how and responsive service and support across the globe, we build collaborative partnerships to meet rapid technological developments, propel growth for our customers, and innovate the future of power.

PRECISION | POWER | PERFORMANCE | TRUST

---

Specifications are subject to change without notice. Not responsible for errors or omissions. ©2025 Advanced Energy Industries, Inc. All rights reserved. Advanced Energy®, and AE® are U.S. trademarks of Advanced Energy Industries, Inc.

FCM10K Series Rev.02.08.25\_#1.0