

ARTESYN LPQ200-M SERIES

200 Watts (forced air)
100 Watts (convection)



PRODUCT DESCRIPTION

Advanced Energy’s Artesyn LPQ200-M series with a 3 x 5 in footprint and a height of 1.32 in (less than 1U), offer a power density of more than 10 W per cubic inch and are capable of achieving efficiencies of up to 84 percent at full load. They are certified with ITE and medical safety approvals, making them ideal for use in a variety of IT, communications, medical, dental and laboratory applications. Outputs are adjustable from minus 20 percent to plus 10 percent and the power supplies can operate with input voltages of 90 Vac to 264 Vac (120 Vdc to 300 Vdc) and feature a maximum safety ground leakage current of just 275 uA with a 264 Vac input. LPQ200-M series power supplies are rated for operation from 0 to plus 50 degrees Celsius without derating, up to 70 degrees Celsius with derating, and can cold-start from temperatures as low as minus 20 degrees Celsius.

SPECIAL FEATURES

- Medical and ITE safeties
- Active power factor correction
- 3” x 5” footprint
- Less than 1U high
- EN61000-3-2 compliant
- Remote sense
- Power fail
- Adjustable output
- Built-in Class B EMI filter
- Overvoltage protection
- Overload protection
- Thermal overload protection
- LPX200 enclosure kit available

SAFETY

- TUV 62368 / 60601-1
- UL 60950 / 60601-1
- CSA 62368 / 60601-1
- CB Certificate and report
- CE Mark (LVD)

AT A GLANCE

Total Power

100 to 200 Watts

Input Voltage

90 to 264 Vac

of Outputs

Quad



MODEL NUMBERS

Standard	Output Voltage	Minimum Load	Maximum Load Convection Cooling (IO,maxCC)	Maximum Load Forced Air 30CFM (IO,maxFA)	Peak Load ¹	Regulation ²	Ripple P/P(PARD) ³
LPQ201-M	+3.3 V	0 A	13 A	18 A	20 A	± 2%	50 mV
	+5 V	0 A	13 A	18 A	20 A	± 5%	50 mV
	+12 V	0 A	5 A	9 A	10 A	± 5%	120 mV
	-12 V	0 A	1 A	2 A	2.5 A	± 5%	120 mV
LPQ202-M	+5 V	0 A	13 A	18 A	20 A	± 2%	50 mV
	+12 V	0 A	5 A	9 A	10 A	± 5%	120 mV
	+24 V	0 A	1.5 A	3 A	3.5 A	± 7%	240 mV
	-12 V	0 A	1 A	2 A	2.5 A	± 5%	120 mV

Note 1 - Peak current lasting <30 seconds with a maximum 10% duty cycle.

Note 2 - At 25 °C including initial tolerance, line voltage, load currents and output voltages adjusted to factory settings.

Note 3 - Peak-to-peak with 20 MHz bandwidth and 10 μF (tantalum capacitor) in parallel with a 0.1 μF capacitor at rated line voltage and ranges.

Options

None

ELECTRICAL SPECIFICATIONS

Absolute Maximum Ratings

Stress in excess of those listed in the “Absolute Maximum Ratings” may cause permanent damage to the power supply. These are stress ratings only and functional operation of the unit is not implied at these or any other conditions above those given in the operational sections of this TRN. Exposure to any absolute maximum rated condition for extended periods may adversely affect the power supply’s reliability.

Table 1. Absolute Maximum Ratings							
Parameter	Model	Symbol	Min	Typ	Max	Unit	
Input Voltage	AC continuous operation	All models	$V_{IN,AC}$	90	-	264	Vac
	DC continuous operation	All models	$V_{IN,DC}$	120	-	300	Vdc
Maximum Output Power Convection continuous operation	All models All models	$P_{O,maxCC}$	-	-	100	W	
Maximum Output Power Forced air continuous operation – 30CFM	All models All models	$P_{O,maxFA}$	-	-	200	W	
Isolation Voltage	Input to outputs	All models	-	-	4000	Vac	
	Input to safety ground	All models	-	-	1500	Vac	
	Output to output	All models	-	-	100	Vdc	
	Outputs to ground	All models	-	-	500	Vac	
Ambient Operating Temperature	All models	T_A	0	-	+70 ¹	°C	
Cold Start-up Temperature	All models	T_{ST}	-20	-	-	°C	
Storage Temperature	All models	T_{STG}	-40	-	+85	°C	
Humidity (non-condensing)	Operating	All models	10	-	90	%	
	Non-operating	All models	10	-	95	%	
Altitude	Operating	All models	-500	-	13,000 ²	feet	
	Non-operating	All models	-1,000	-	50,000	feet	

Note 1 - Derate each output at 2.5% per degree C from 50°C to 70°C.

Note 2 - Derate maximum operating temperature by 1°C per 1,000 feet above 13,000 feet.

ELECTRICAL SPECIFICATIONS

Input Specifications

Table 2. Input Specifications						
Parameter	Condition	Symbol	Min	Typ	Max	Unit
Operating Input Voltage, AC	All	$V_{IN,AC}$	90	230	264	Vac
Input AC Frequency	All	F_{IN}	47	-	63	Hz
Operating Input Voltage, DC	All	$V_{IN,DC}$	120	-	300	Vdc
Maximum steady state Input Current	$V_{IN,AC} = 90 V_{AC}$	$I_{IN,max}$	-	-	2.6	Aac
No Load Input Current ($V_O = \text{nominal}$, $I_O = 0A$)	$V_{IN,AC} = 90 V_{AC}$ $V_{IN,AC} = 264 V_{AC}$	$I_{IN,no-load}$	-	150 250	-	mAac
Harmonic Line Currents	All	THD	Per EN61000-3-2			
Power Factor	$V_{IN,AC} = 115Vac$ $P_O = P_{O,maxFA}$	PF	0.90	-	-	
Startup Surge Current (Inrush) @ 25°C	$V_{IN,AC} = 230V_{AC}$	$I_{IN,inrush}$	-	-	50	A_{PK}
Input Fuse	Internal, L and N F2A5, 250V, Type 392		-	-	2.5	A
Input AC Undervoltage Lockout Voltage	$P_O = P_{O,maxFA}$	$V_{IN,AC-stop}$	65	-	75	Vac
Input AC Low Line Start-up Voltage	$P_O = P_{O,maxFA}$	$V_{IN,AC-star}$	65	-	75	Vac
No Load Input Power ($V_O = \text{nominal}$, $I_O = 0$)	$V_{IN,AC} = 115/230V_{AC}$	$P_{IN,no-load}$	-	-	12	W
PFC Switching Frequency	All	$f_{SW,PFC}$	45	-	55	KHz
Ripple Switching Frequency	All	$f_{SW,DC-DC}$	115	-	135	KHz
Efficiency ($T_A = 25^\circ C$, forced air cooling)	$V_{IN,AC} = 100Vac$ $P_O = P_{O,maxFA}$	η	84	-	-	%
Hold Up Time	$V_{IN,AC} = 115Vac$ $P_O = P_{O,maxFA}$	$t_{Hold-Up}$	16	-	-	mSec
Turn On Delay Time	$V_{IN,AC} = 90Vac$ $P_O = P_{O,maxFA}$	$t_{Turn-On}$	-	-	2	Sec
Leakage Current to safety ground	$V_{IN} = 264Vac$ $f_{IN} = 50/60 \text{ Hz}$	$I_{IN,leakage}$	-	-	275	μA
System	Phase Margin Gain Margin	330mF/A Capacitive Load	45 10	- -	- -	\emptyset dB

ELECTRICAL SPECIFICATIONS

Output Specifications

Table 3. Output Specifications							
Parameter		Condition	Symbol	Min	Typ	Max	Unit
Output Regulation	LPQ201-M	Inclusive of setpoint, line, load temperature change, warm-up drift and cross regulation	V ₁	3.234	3.30	3.366	V
			V ₂	4.9	5.0	5.1	
			V ₃	11.4	12.0	12.6	
			V ₄	-11.4	-12.0	-12.6	
	LPQ202-M		V ₁	4.9	5.0	5.1	V
			V ₂	11.4	12.0	12.6	
			V ₃	23.28	24.0	24.72	
			V ₄	-11.4	-12.0	-12.6	
Output Ripple, PK-PK	LPQ201-M	Measure with a 0.1µF ceramic capacitor in parallel with a 10µF tantalum capacitor	V ₁	-	-	50	mV _{PK-PK}
			V ₂	-	-	50	
			V ₃	-	-	120	
			V ₄	-	-	120	
	LPQ202-M		V ₁	-	-	50	mV _{PK-PK}
			V ₂	-	-	120	
			V ₃	-	-	240	
			V ₄	-	-	120	
Convection Output Current, continuous	LPQ201-M	Convection cooling	I _{O,maxCC}	0	-	13	A
				0	-	13	
		0		-	5		
		0		-	1		
	LPQ202-M		I _{O,maxCC}	0	-	13	A
		0		-	5		
		0		-	1.5		
		0		-	1		
Maximum Convection Output Power, continuous	All models	All outputs	P _{O,maxCC}	-	-	100	W
Force Air Output Current, continuous	LPQ201-M	30 CFM force air cooling	I _{O,maxFA}	0	-	18	A
				0	-	18	
		0		-	5		
		0		-	1		
	LPQ202-M		I _{O,maxFA}	0	-	18	A
		0		-	9		
		0		-	3		
		0		-	2		
Maximum Force air Output Power, continuous	All models	Main output , 30 CFM	P _{O,maxFA}	-	-	200	W
Output Current, peak	LPQ201-M	Maximum duration <30 seconds, maximum duty cycle <10%	I _{O,peak}	-	-	20	A
				-	-	20	
		-		-	10		
		-		-	2.5		
	LPQ202-M		I _{O,peak}	-	-	20	A
		-		-	10		
		-		-	3.5		
		-		-	2.5		

ELECTRICAL SPECIFICATIONS

Output Specifications

Table 3. Output Specifications Con't							
Parameter		Condition	Symbol	Min	Typ	Max	Unit
Output Adjust Range	LPQ201-M	$V_{IN,AC} = 100V_{AC}$ $I_O = 0A$	%V ₁	-15	-	+10	%
			%V ₂	-20	-	+10	
		%V ₃	-20	-	+10		
		%V ₄	-20	-	+10		
	LPQ202-M		%V ₁	-20	-	+10	%
			%V ₂	-20	-	+10	
			%V ₃	-10	-	+20	
			%V ₄	-20	-	+10	
V _O Capacitive Load	LPQ201-M	Startup	-	0	-	330	μF/A
			-		-	330	μF/A
			-	-	-	1500	μF
			-	-	-	330	μF/A
	LPQ201-M		-	0	-	330	μF/A
			-		-	-	1500
			-	-	-	330	μF
			-	-	-	330	μF/A
V _O Dynamic Response - Peak Deviation	LPQ201-M	50% (50% to 100% of I _{O,maxFA}) load change Slew rate = 1A/μs Output capacitance = 100μF/A	V	-	-	165	mV
			-	-	-	250	
			-	-	-	600	
			-	-	-	480	
	LPQ202-M		V	-	-	250	mV
			-	-	-	600	
			-	-	-	960	
			-	-	-	480	
V _O Dynamic Response - Setting Time	All models	50% (50% to 100% of I _{O,maxFA}) load change Slew rate = 1A/μs Output capacitance = 100μF/A	t _s	-	-	500	μSec
V _O Turn On Overshoot	LPQ201-M	I _O = 0	V	-	-	150	mV
			-	-	-	150	
			-	-	-	360	
			-	-	-	360	
	LPQ202-M		V	-	-	150	mV
			-	-	-	360	
			-	-	-	720	
			-	-	-	360	
V _O Long Term Stability	LPQ201-M	Max change over 24 hours after thermal equilibrium (30 mins)	±%V _O	-	-	0.1	%
			-	-	0.1		
			-	-	-	1.0	
			-	-	-	1.0	
	LPQ202-M		±%V _O	-	-	0.1	%
			-	-	-	1.0	
			-	-	-	1.0	
			-	-	-	1.0	
V _O Over Voltage Protection		Latch off (AC recycle to reset)	%V _O	130	-	150	%

ELECTRICAL SPECIFICATIONS

Output Specifications

Table 3. Output Specifications Con't						
Parameter	Condition	Symbol	Min	Typ	Max	Unit
V _O Over Current Protection	All	%I _O	110	-	160	%
Over Temperature Protection	All		Auto Recovery			
Short Circuit Protection	All		Auto Recovery			
Remote Sense, + and -	Maximum compensation at each output line	V _{SENSE}	-	-	500	mV

ELECTRICAL SPECIFICATIONS

System Timing Diagram

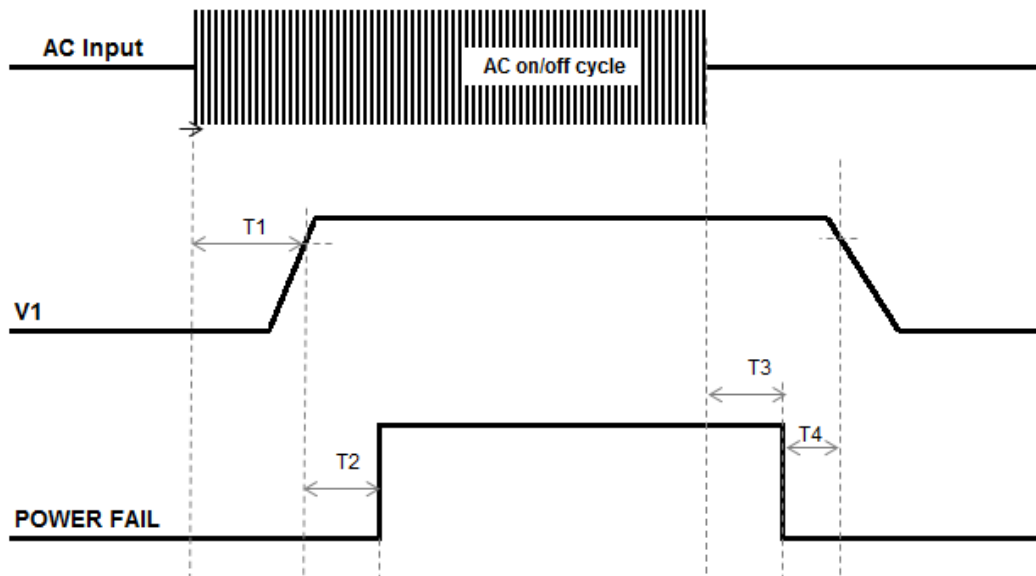

Table 7. Timing specifications of the Power Fail signal						
Parameter	Condition	Symbol	Min	Typ	Max	Unit
Turn On Delay T1	$V_{IN,AC} = 100Vac$ $P_O = P_{O,maxFA}$	T1	-	-	2	Sec
Power Fail Delay T2	$V_{IN,AC} = 100Vac$ $P_O = P_{O,maxFA}$	T2	100	-	500	mSec
Power Fail Warning T3	$V_{IN,AC} = 100Vac$ $P_O = P_{O,maxFA}$	T3	12	-	-	mSec
Turn Off Delay T4	$V_{IN,AC} = 100Vac$ $P_O = P_{O,maxFA}$	T4	4	-	-	mSec
Power Fail Delay T3+T4	$V_{IN,AC} = 100 Vac$ $P_O = P_{O,maxFA}$	T3+T4	16	-	-	mSec

ELECTRICAL SPECIFICATIONS

LPQ201-M Performance Curves

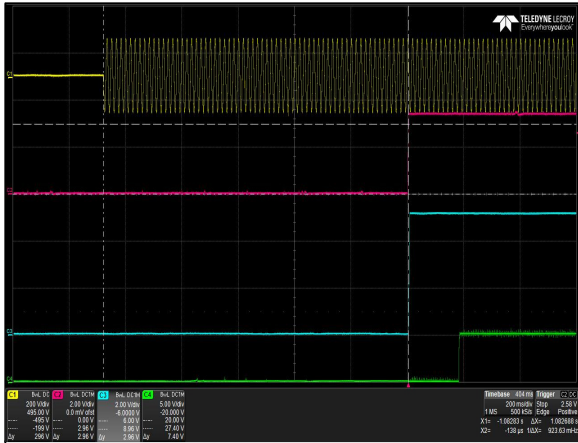

Figure 1: LPQ201-M Turn-on delay
 Vin = 100Vac Load: Pout = 200W
 Ch 1: VIN Ch 2: 3.3V Ch 3: 5.0V Ch 4: Power Fail

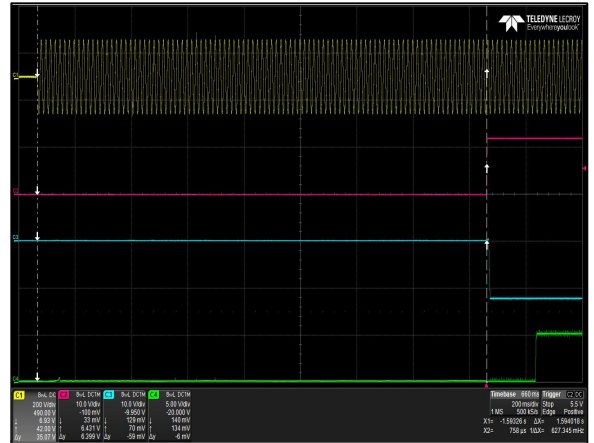

Figure 2: LPQ201-M Turn-on delay
 Vin = 100Vac Load: Pout = 200W
 Ch 1: VIN Ch 2: 12V Ch 3: -12.0V Ch 4: Power Fail

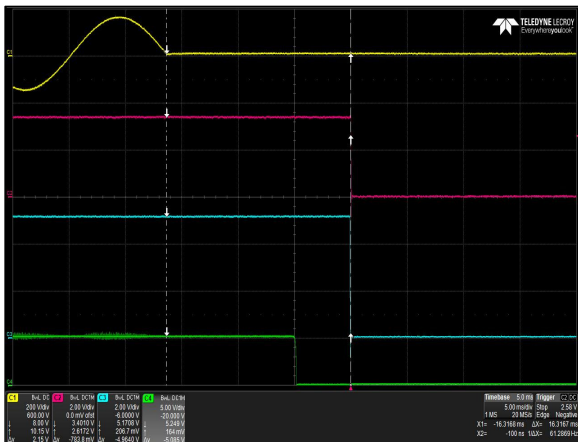

Figure 3: LPQ201-M Hold-up Time (time to decay)
 Vin = 100Vac Load: Pout = 200W
 Ch 1: VIN Ch 2: 3.3V Ch 3: 5.0V Ch 4: Power Fail

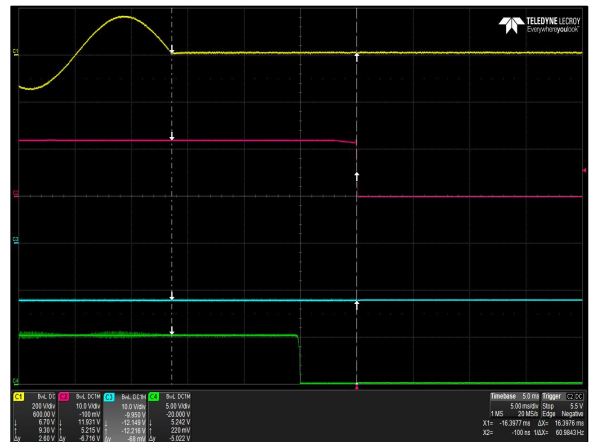

Figure 4: LPQ201-M Hold-up Time (time to decay)
 Vin = 100Vac Load: Pout = 200W
 Ch 1: VIN Ch 2: 12V Ch 3: -12.0V Ch 4: Power Fail

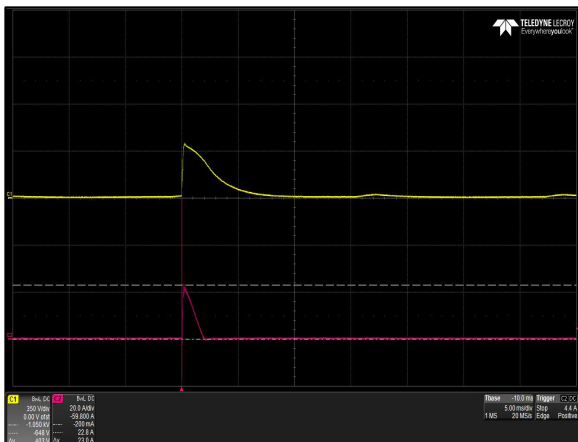

Figure 5: LPQ201-M Inrush Current
 Vin = 264Vac Load: Io = 0A, Turn on at 90 deg
 Ch 1: VIN Ch 2: IIN

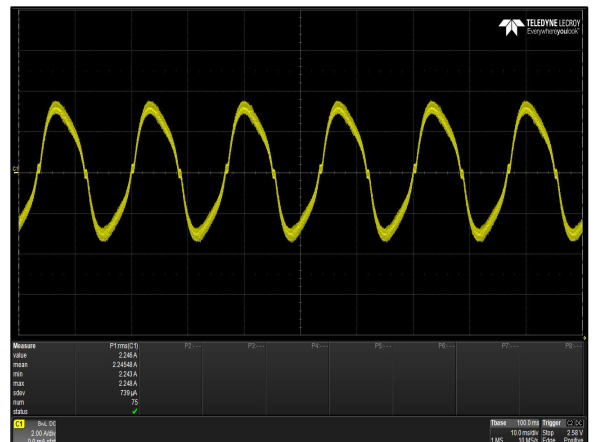

Figure 6: LPQ201-M Input Current Waveform
 Vin = 100Vac Load: Pout = 200W
 Ch 1: IIN

ELECTRICAL SPECIFICATIONS

LPQ201-M Performance Curves

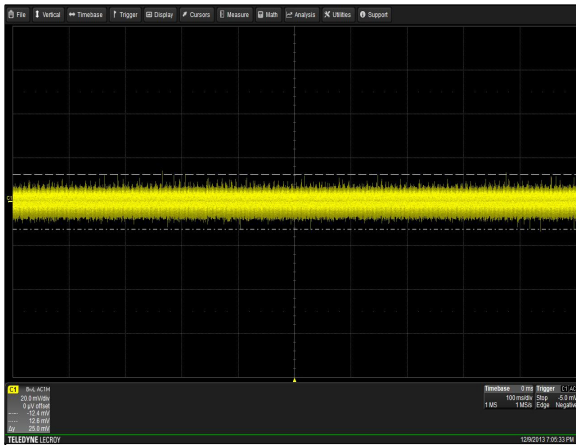

Figure 7: LPQ201-M Ripple and Noise Measurement
 Vin = 230Vac Load: Vout1 = 3.3V, Iout1 = 13A
 Ch 1: Vout1

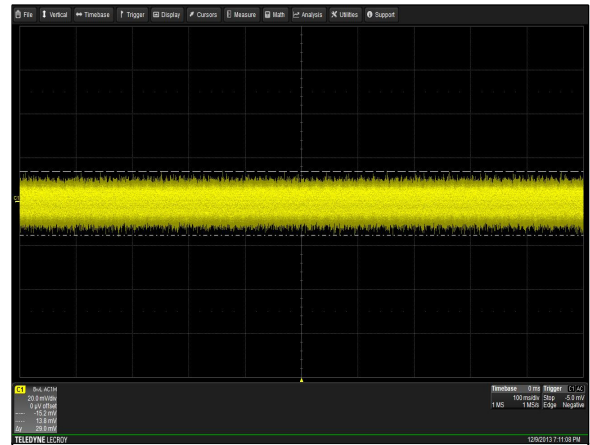

Figure 8: LPQ201-M Ripple and Noise Measurement
 Vin = 230Vac Load: Vout2 = 5.0V, Iout2 = 13A
 Ch 1: Vout2

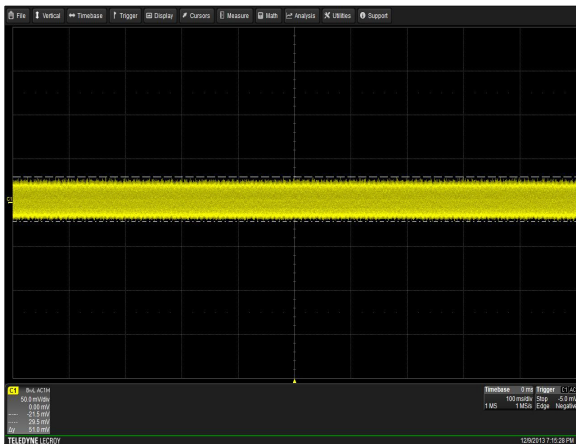

Figure 9: LPQ201-M Ripple and Noise Measurement
 Vin = 230Vac Load: Vout3 = 12V, Iout3 = 5A
 Ch 1: Vout3

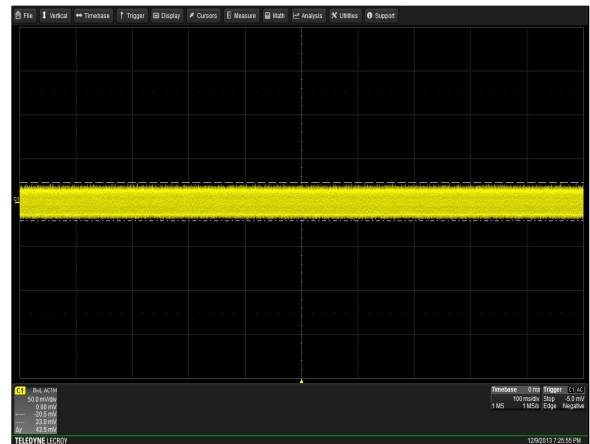

Figure 10: LPQ201-M Ripple and Noise Measurement
 Vin = 230Vac Load: Vout4 = -12V, Iout4 = 1A
 Ch 1: Vout4

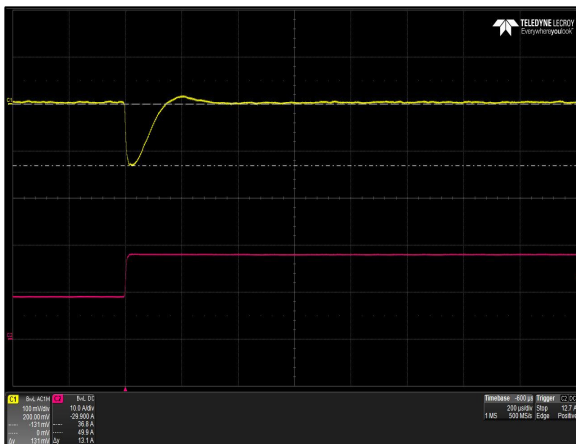

Figure 11: LPQ201-M Transient Response – Vo Deviation
 Vin = 230Vac Load: Vout1 = 3.3V, Iout1 = 9A to 18A
 Ch 1: Vout1 Ch 2: Iout1 Remote sense connected

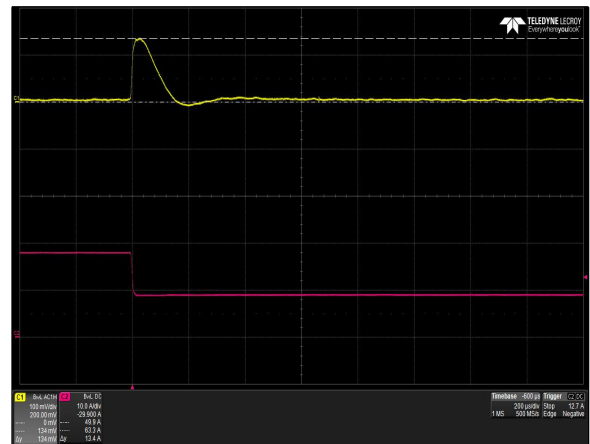

Figure 12: LPQ201-M Transient Response – Vo Deviation
 Vin = 230Vac Load: Vout1 = 3.3V, Iout1 = 18A to 9A
 Ch 1: Vout1 Ch 2: Iout1 Remote sense connected

ELECTRICAL SPECIFICATIONS

LPQ201-M Performance Curves

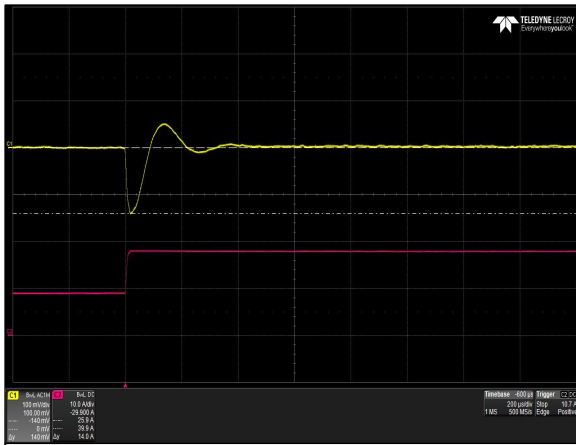

Figure 13: LPQ201-M Transient Response – Vo Deviation
 Vin = 230Vac Load: Vout2 = 5.0V, Iout2 = 9A to 18A
 Ch 1: Vout2 Ch 2: Iout2 Remote sense connected

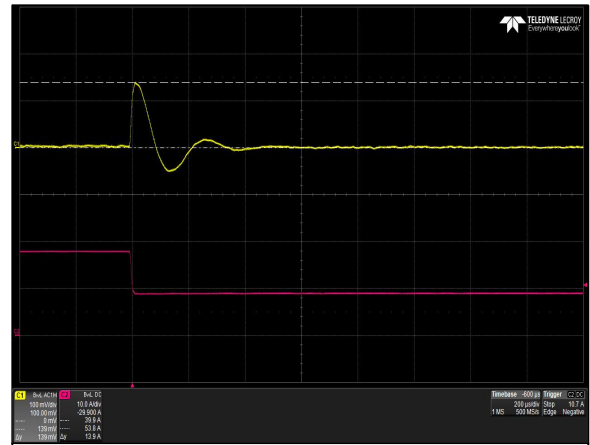

Figure 14: LPQ201-M Transient Response – Vo Deviation
 Vin = 230Vac Load: Vout2 = 5.0V, Iout2 = 18A to 9A
 Ch 1: Vout2 Ch 2: Iout2 Remote sense connected

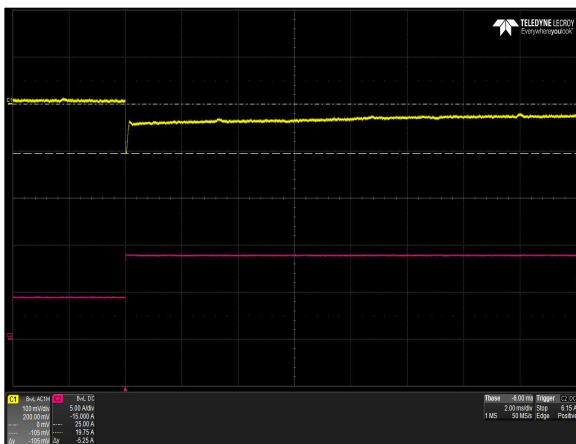

Figure 15: LPQ201-M Transient Response – Vo Deviation
 Vin = 230Vac Load: Vout3 = 12.0V, Iout3 = 4.5A to 9A
 Ch 1: Vout3 Ch 2: Iout3 Remote sense connected

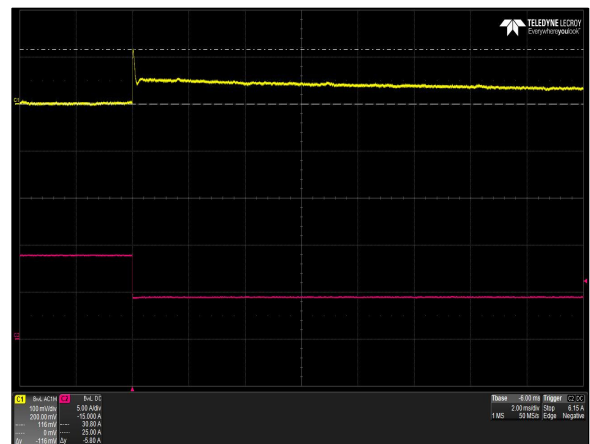

Figure 16: LPQ201-M Transient Response – Vo Deviation
 Vin = 230Vac Load: Vout3 = 12.0V, Iout3 = 9A to 4.5A
 Ch 1: Vout3 Ch 2: Iout3 Remote sense connected

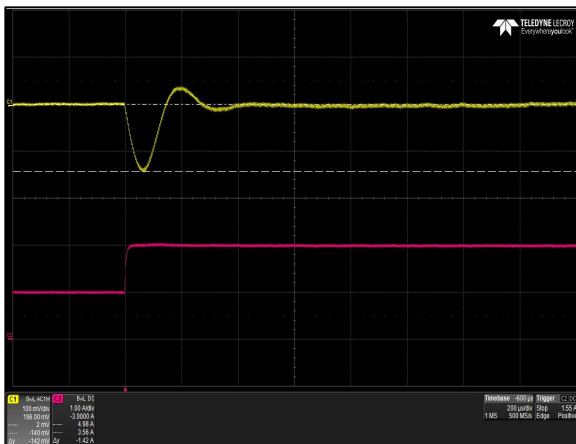

Figure 17: LPQ201-M Transient Response – Vo Deviation
 Vin = 230Vac Load: Vout4 = -12.0V, Iout4 = 1A to 2A
 Ch 1: Vout4 Ch 2: Iout4 Remote sense connected

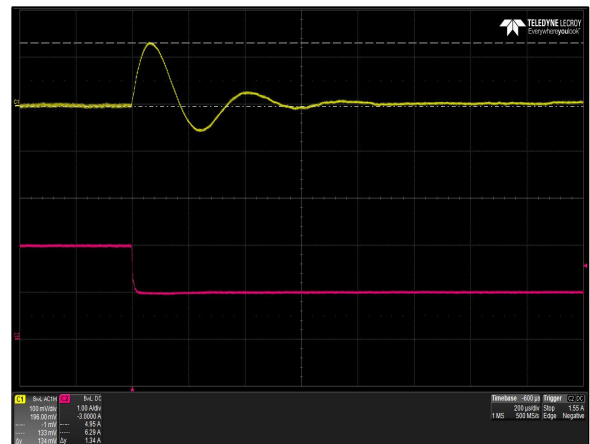

Figure 18: LPQ201-M Transient Response – Vo Deviation
 Vin = 230Vac Load: Vout4 = -12.0V, Iout4 = 2A to 1A
 Ch 1: Vout4 Ch 2: Iout4 Remote sense connected

ELECTRICAL SPECIFICATIONS

LPQ201-M Performance Curves

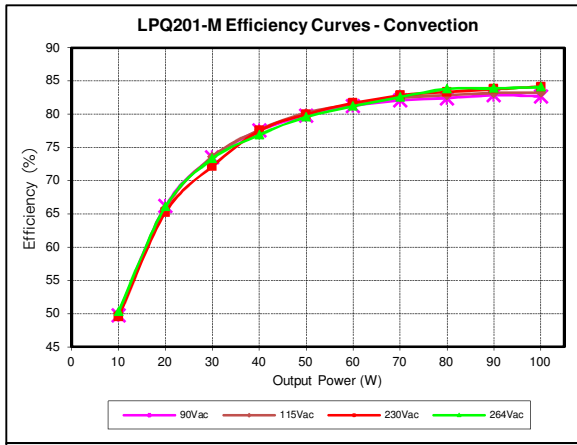

Figure 19: LPQ201-M Efficiency Curves @ 25 degC
Convection Cooling
Vin = 90 to 264Vac Load: Pout = 0 to 100W

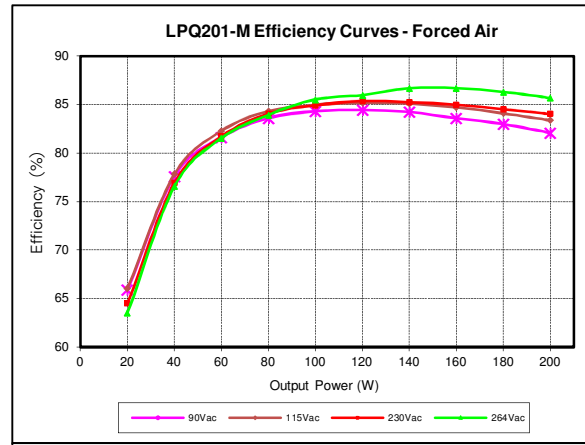

Figure 20: LPQ201-M Efficiency Curves @ 25 degC
30CFM Forced Air
Vin = 90 to 264Vac Load: Pout = 0 to 200W

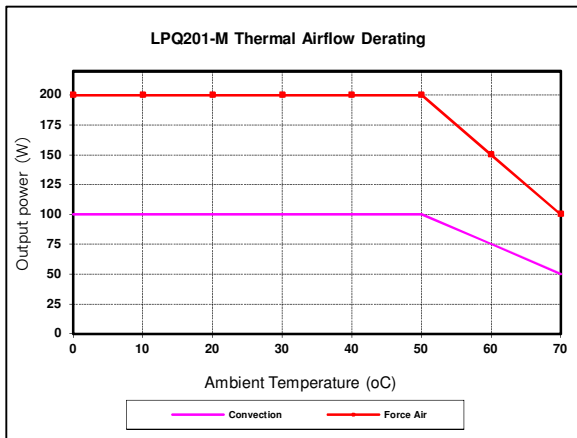
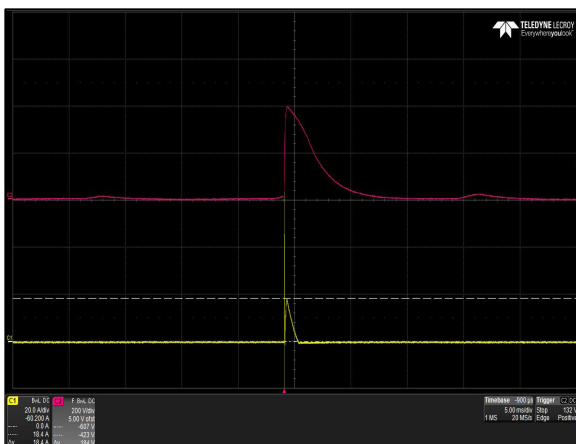
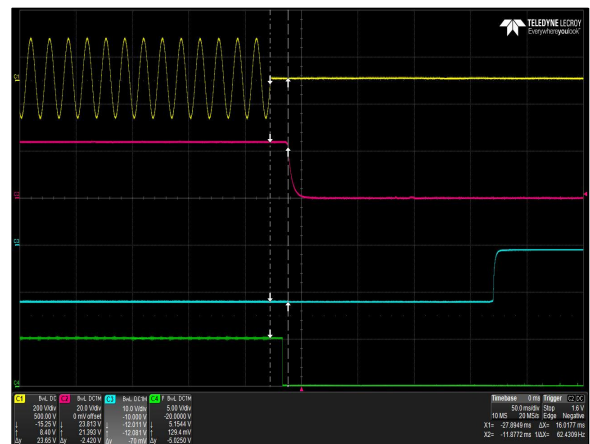
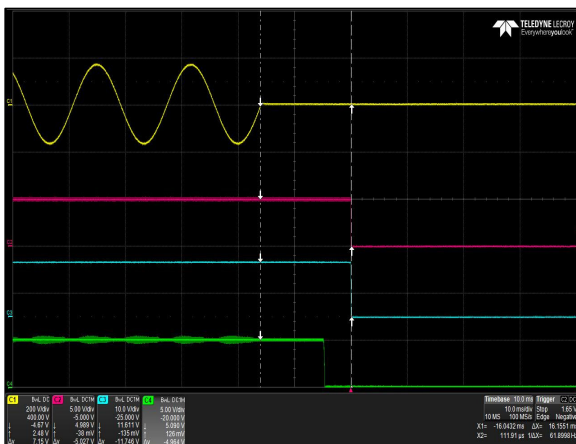
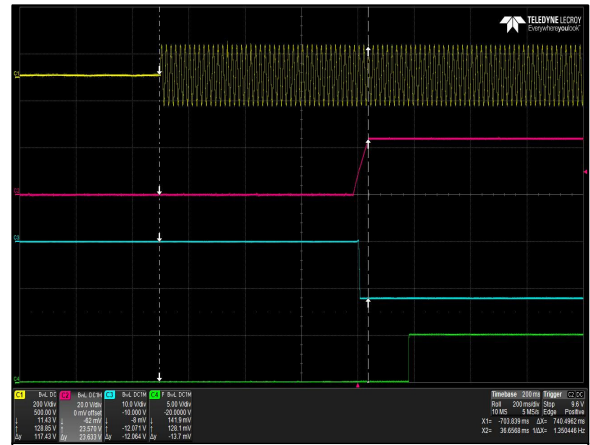
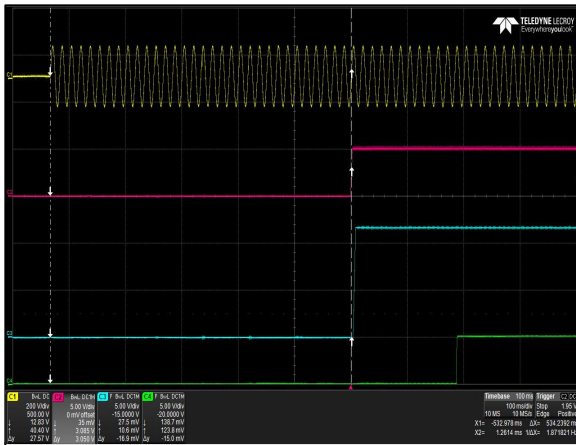

Figure 21: LPQ201-M Derating Curves
Vin = 115Vac Load: Pout = 0 to 200W

ELECTRICAL SPECIFICATIONS

LPQ202-M Performance Curves



ELECTRICAL SPECIFICATIONS

LPQ202-M Performance Curves

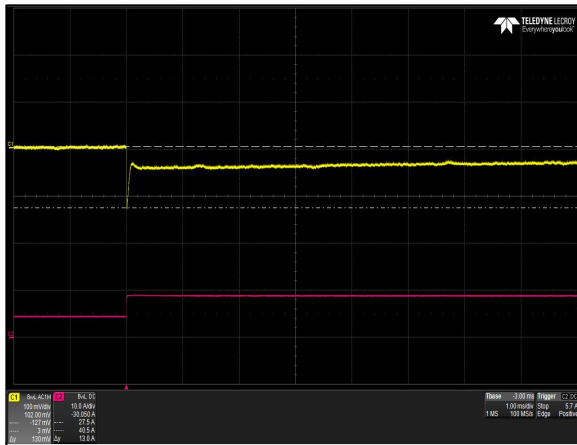

Figure 34: LPQ202-M Transient Response – Vo Deviation
 Vin = 230Vac Load: Vout2 = 12.0V, Iout2 = 4.5A to 9A
 Ch 1: Vout2 Ch 2: Iout2 Remote sense connected

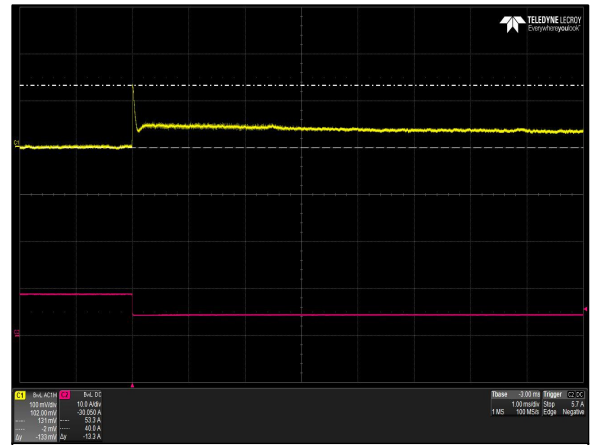

Figure 35: LPQ202-M Transient Response – Vo Deviation
 Vin = 230Vac Load: Vout2 = 12.0V, Iout2 = 9A to 4.5A
 Ch 1: Vout2 Ch 2: Iout2 Remote sense connected

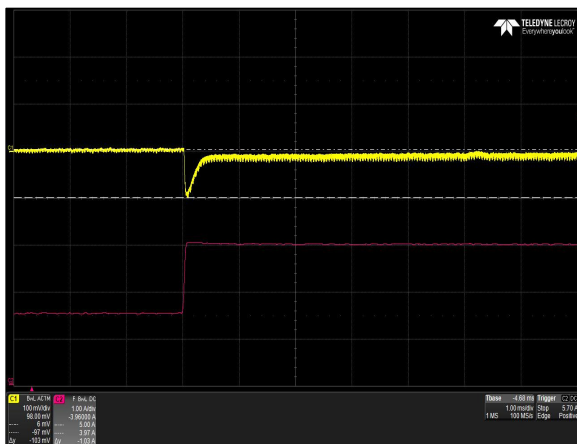

Figure 36: LPQ202-M Transient Response – Vo Deviation
 Vin = 230Vac Load: Vout3 = 24.0V, Iout3 = 1.5A to 3A
 Ch 1: Vout3 Ch 2: Iout3 Remote sense connected

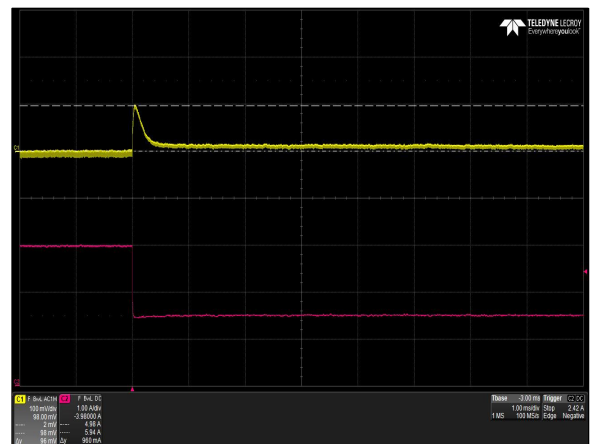

Figure 37: LPQ202-M Transient Response – Vo Deviation
 Vin = 230Vac Load: Vout3 = 24.0V, Iout3 = 3A to 1.5A
 Ch 1: Vout3 Ch 2: Iout3 Remote sense connected

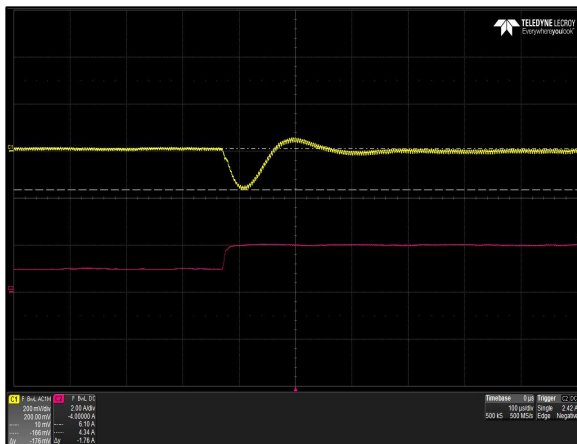

Figure 38: LPQ202-M Transient Response – Vo Deviation
 Vin = 230Vac Load: Vout4 = -12.0V, Iout4 = 1A to 2A
 Ch 1: Vout4 Ch 2: Iout4 Remote sense connected

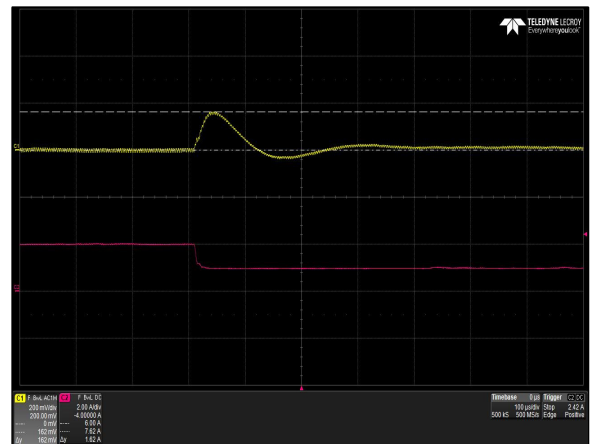

Figure 39: LPQ202-M Transient Response – Vo Deviation
 Vin = 230Vac Load: Vout4 = -12.0V, Iout4 = 2A to 1A
 Ch 1: Vout4 Ch 2: Iout4 Remote sense connected

ELECTRICAL SPECIFICATIONS

LPQ202-M Performance Curves

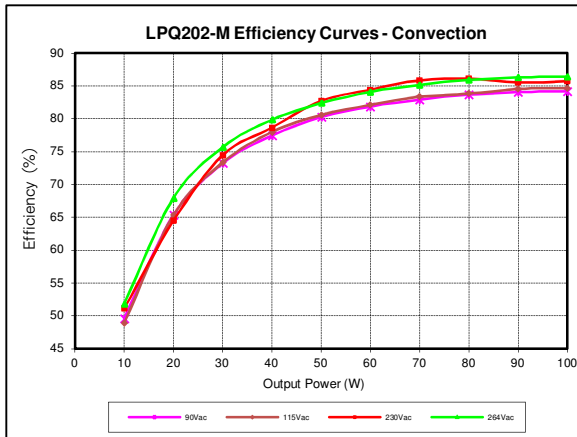

Figure 40: LPQ202-M Efficiency Curves @ 25 degC
Convection Cooling
Vin = 90 to 264Vac Load: Pout = 0 to 100W

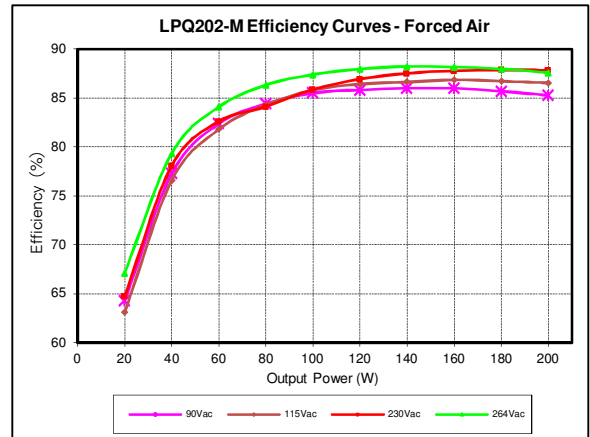

Figure 41: LPQ202-M Efficiency Curves @ 25 degC
30CFM Forced Air
Vin = 90 to 264Vac Load: Pout = 0 to 200W

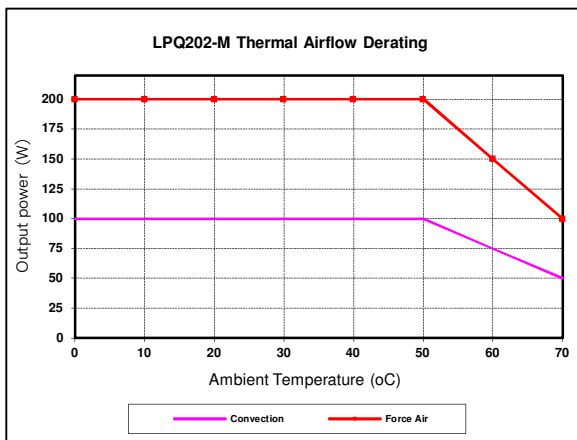

Figure 42: LPQ202-M Derating Curves
Vin = 115Vac Load: Pout = 0 to 200W

ELECTRICAL SPECIFICATIONS

Protection Function Specifications

Input Fuse

Protective fuse will be provided on the “Line” and “Neutral” side of the primary line of each power supply.

Over Voltage Protection (OVP)

Over-voltage protection will be provided for V1 and V2 on the LPQ201-M and V1 on the LPQ202-M referenced to the minus remote sense. The over-voltage point will be between 130% and 150% of nominal output. The power supply must latch off during over-voltage with the AC line recycled to reset the latch.

LPQ201-M

Parameter	Min	Typ	Max	Unit
3.3V Output Overvoltage	4.29	/	4.95	V
5V Output Overvoltage	6.5	/	7.5	V
12V Output Overvoltage	-	-	-	V
-12V Output Overvoltage	-	-	-	V

LPQ202-M

Parameter	Min	Typ	Max	Unit
5V Output Overvoltage	6.5	/	7.5	V
12V Output Overvoltage	-	-	-	V
24V Output Overvoltage	-	-	-	V
-12V Output Overvoltage	-	-	-	V

ELECTRICAL SPECIFICATIONS

Over Current Protection (OCP)

The OCP range for V1, V2 and V3 output is 110% - 160% of full load, and 150% - 250% for V4 output at nominal line 47 – 63Hz.

LPQ201-M

Parameter	Min	Typ	Max	Unit
3.3V Output Overvoltage	19.8	/	28.8	A
5V Output Overvoltage	19.8	/	28.8	A
12V Output Overvoltage	9.9	/	14.4	A
-12V Output Overvoltage	3	/	5	A

LPQ202-M

Parameter	Min	Typ	Max	Unit
5V Output Overvoltage	19.8	/	28.8	A
12V Output Overvoltage	9.9	/	14.4	A
24V Output Overvoltage	3.3	/	4.8	A
-12V Output Overvoltage	3	/	5	A

Short Circuit Protection (SCP)

The power supply will protect itself when any output is shorted to ground or to any other output. The power supply will withstand a continuous short circuit with no permanent damage. The power supply will automatically restart when shorts to ground are removed. A short is defined as impedance less than 50 milliohms.

Over Temperature Protection (OTP)

The power supply will shut down in the event over temperature. Automatic recovery when the temperature falls below OTP threshold (including hysteresis).

MECHANICAL SPECIFICATIONS

Mechanical Outlines (Dimensioning and Mounting Locations)

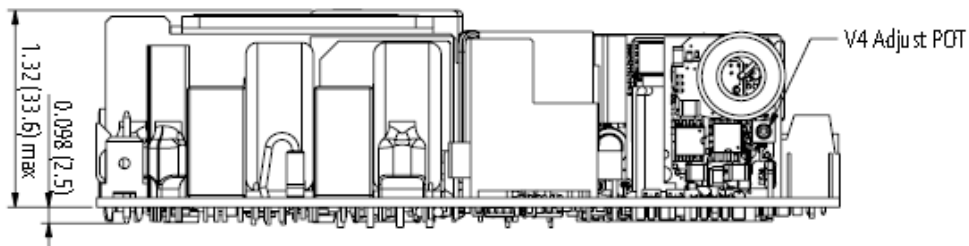
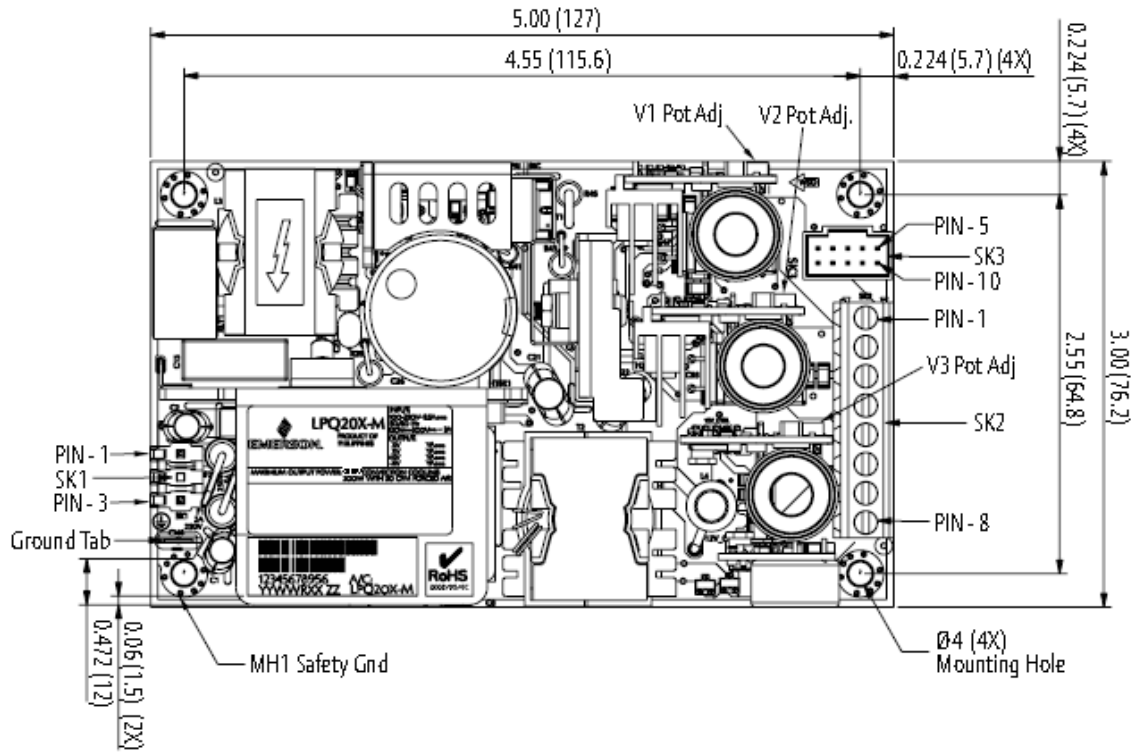

- All dimensions in inches [mm], tolerance is +/-0.02" [0.5mm]
- Mounting holes M1 should be grounded for EMI purpose
- Mounting hole M1 is safety ground connection
- This power supply requires mounting on standoffs 0.20" [5.0mm] in height

MECHANICAL SPECIFICATIONS

Connector Definitions

AC Input Connector – SK1

Pin 1 - Neutral

Pin 3 - Line

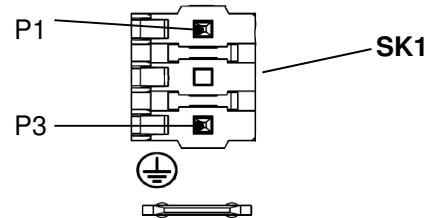

Output Connector – SK2

Pin 1 – V1 OUT

Pin 2 – V2 OUT

Pin 3 – GND OUT

Pin 4 – GND OUT

Pin 5 – GND OUT

Pin 6 – GND OUT

Pin 7 – V3 OUT

Pin 8 – V4 OUT

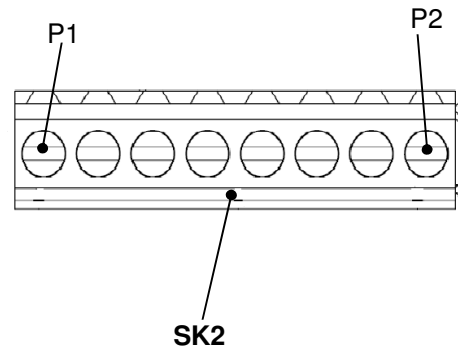

Control Signal Header – SK3

Pin 1 – +V1 Remote sense

Pin 2 – -V1 Remote sense

Pin 3 – N/C

Pin 4 – N/C

Pin 5 – + Power Fail

Pin 6 – Common

Pin 7 – N/C

Pin 8 – Common

Pin 9 – +V2 Remote Sense (LPQ201-M only)

Pin 10 – -V2 Remote Sense (LPQ201-M only)

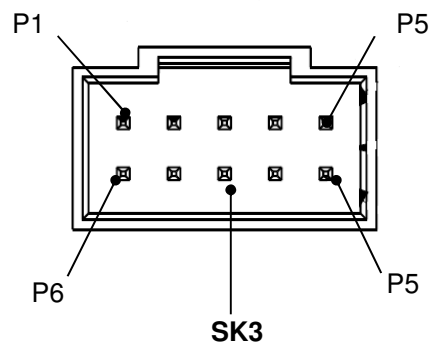

MECHANICAL SPECIFICATIONS

Power / Signal Mating Connectors and Pin Types

Table 4. Mating Connectors for LPQ200-M Series			
Reference	Vendor	Mating Connector or Equivalent	Mating Pins/Terminals or Equivalent
SK1	Molex	09-50-8031	08-52-0113
GND	Molex	01-90020001	
SK3	Molex	90142-0010 (USA)	90119-2110
	LANDWIN	2580S0803	2583T021V

Potentiometer Definitions

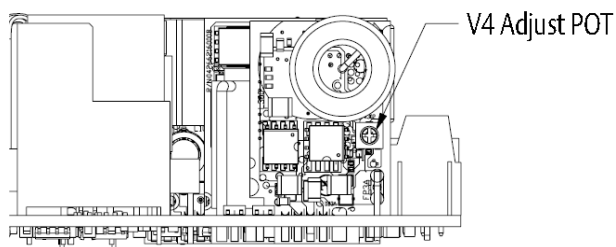
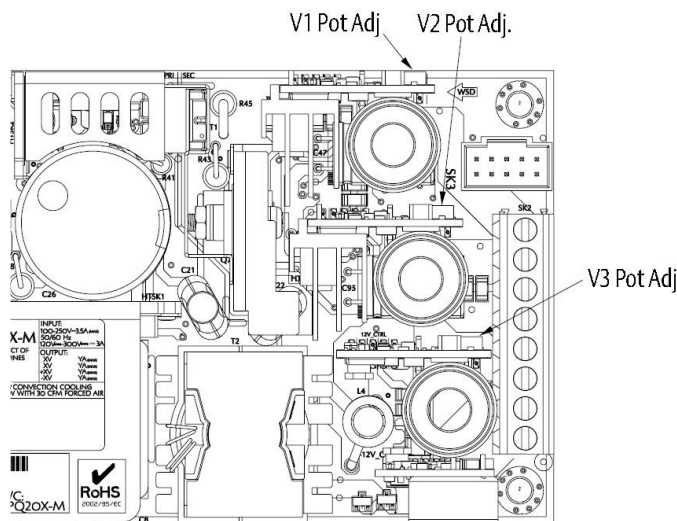

MECHANICAL SPECIFICATIONS

Weight

The LPQ200-M series weight is 1.5 lbs / 681g maximum.

ENVIRONMENTAL SPECIFICATIONS

EMC Immunity

LPQ200-M series power supply is designed to meet the following EMC immunity specifications.

Table 5. Environmental Specifications											
Document	Description										
EN 61000-4-2	ESD up to 4kV contact, 8kV discharge										
EN61000-4-3	RFI 3V/m										
EN 61000-4-4	Electrical Fast Transients level 3 minimum										
EN 61000-4-5	Surge level 3 minimum										
EN 61000-4-6	Radio frequency common mode, Levels 3V (rms) Modulated AM 80%, 1 kHz, 150 ohm source impedance										
EN 61000-4-8	Power Frequency Magnetic Immunity, 1 A/m										
EN 61000-4-11	<p>AC Input transients (Reference EN 60601-1:2001)</p> <table border="0"> <thead> <tr> <th>Condition</th> <th>Criteria</th> </tr> </thead> <tbody> <tr> <td>> 95% dip, 0.5 period</td> <td>A</td> </tr> <tr> <td>60% dip, 5.0 periods</td> <td>B (A when Vin >160 VAC)</td> </tr> <tr> <td>30% dip, 25 periods</td> <td>A</td> </tr> <tr> <td>> 95% dip, 5 Sec</td> <td>B</td> </tr> </tbody> </table> <p>Note: For conditions where Criteria A cannot be met, characterize the boundary condition (Line and/or Load) where Criteria A becomes Criteria B.</p>	Condition	Criteria	> 95% dip, 0.5 period	A	60% dip, 5.0 periods	B (A when Vin >160 VAC)	30% dip, 25 periods	A	> 95% dip, 5 Sec	B
Condition	Criteria										
> 95% dip, 0.5 period	A										
60% dip, 5.0 periods	B (A when Vin >160 VAC)										
30% dip, 25 periods	A										
> 95% dip, 5 Sec	B										
EN 61000-3-2	Harmonic currents emission										
EN60601-1-2 Latest amendment	European Community Safety investigated and marketed by TUV or VDE										
CSA 601-1 and -C22.2 No. 60950	Standards for safety										
CE Marking	LVD and EMC										

ENVIRONMENTAL SPECIFICATIONS

Safety Certifications

The LPQ200-M series power supply is intended for inclusion in other equipment and the installer must ensure that it is in compliance with all the requirements of the end application. This product is only for inclusion by professional installers within other equipment and must not be operated as a stand alone product.

Table 6. Safety Certifications for LPQ200-M Series Power Supply System		
Document	File #	Description
UL60950-1 (or latest)	E186249-A120-UL	Safety of information Technology Equipment, including electrical business equipment
IEC 60950-1(ed.2), IEC 60950-1(ed.2);am1, IEC 60950-1(ed.2);am2	DK-48619-UL	International Requirements
IEC 60601-1:2005, IEC 60601-1:2005/AMD1:2012	SG PSB-MD-00098	211-600479-000
UL 60601-1 1st Ed / CSA-C22.2 No. 601.1-M90	E182560-A16-UL	Safety of Medical Electric Equipment.
EN 62368-1:2014/A11:2017, EN 60601-1:2006/A1:2013	B 013890 3171 Rev. 00	European Community Safety investigated and marketed by TUV
EN60601-1 latest amendment	B 13 01 51485 01249	European Community Safety investigated and marketed by TUV or VDE
CB Certificate and Report	SG-MD-00153A1	(All CENELEC Countries)
CE Mark	13132	LVD

ENVIRONMENTAL SPECIFICATIONS

EMI Emissions

The LPQ200-M series has been designed to comply with the Class B limits of EMI requirements of EN55032 (FCC Part 15) and CISPR 22 (EN55022) for emissions and relevant sections of EN61000 (IEC 61000) for immunity.

The unit is enclosed inside a metal box, tested at 200W using resistive load with cooling fan.

Conducted Emissions

The applicable standard for conducted emissions is EN55022 (FCC Part 15). Conducted noise can appear as both differential mode and common mode noise currents. Differential mode noise is measured between the two input lines, with the major components occurring at the supply fundamental switching frequency and its harmonics. Common mode noise, a contributor to both radiated emissions and input conducted emissions, is measured between the input lines and system ground and can be broadband in nature.

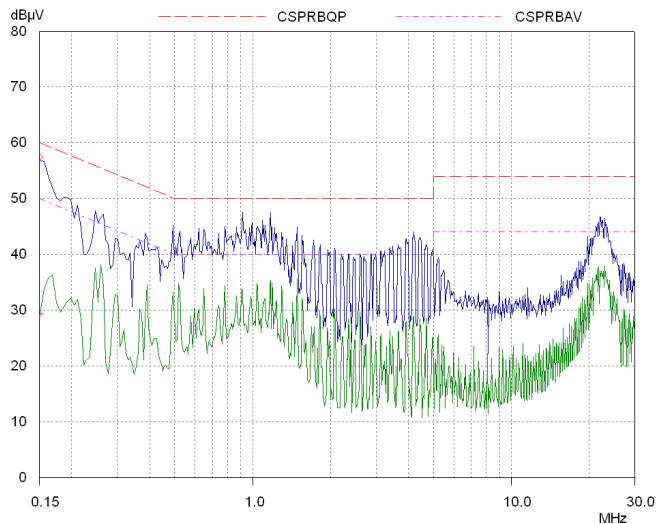

The LPQ200-M series power supply have internal EMI filters to ensure the convertor’s conducted EMI levels comply with EN55022 (FCC Part 15) Class B and EN55022 (CISPR 22) Class B limits. The EMI measurements are performed with resistive loads under forced air convection at maximum rated loading.

Sample of EN55022 Conducted EMI Measurement at 100Vac input

Note: Blue Line refers to Advanced Energy Quasi Peak margin, which is 6dB below the CISPR international limit. Pink Line refers to Advanced Energy Average margin, which is 6dB below the CISPR international limit.

Conducted EMI emissions specifications of the LPQ200-M series:

Parameter	Model	Symbol	Min	Typ	Max	Unit
FCC Part 15, class B	All	Margin	6	-	-	dB
CISPR 22 (EN55022) class B	All	Margin	6	-	-	dB

Radiated Emissions

Unlike conducted EMI, radiated EMI performance in a system environment may differ drastically from that in a stand-alone power supply. The shielding effect provided by the system enclosure may bring the EMI level from Class A to Class B. It is thus recommended that radiated EMI be evaluated in a system environment. The applicable standard is EN55022 Class A (FCC Part 15). Testing ac-dc convertors as a stand-alone component to the exact requirements of EN55022 can be difficult, because the standard calls for 1m leads to be attached to the input and outputs and aligned such as to maximize the disturbance. In such a set-up, it is possible to form a perfect dipole antenna that very few ac-dc convertors could pass. However, the standard also states that ‘an attempt should be made to maximize the disturbance consistent with the typical application by varying the configuration of the test sample’.

ENVIRONMENTAL SPECIFICATIONS

Storage and Shipping Temperature / Humidity

The LPQ200-M series power supply is designed to meet all of its specifications during any combination of operating ambient conditions and after exposure to any combination of non-operating ambient conditions specified in this section.

Altitude

The LPQ200-M series will operate within specifications at altitudes up to 10,000 feet above sea level. The power supply will not be damaged when stored at altitudes of up to 30,000 feet above sea level.

Humidity

The LPQ200-M series will operate within specifications when subjected to a relative humidity from 20% to 90% non-condensing. The LPQ200-M series can be stored in a relative humidity from 10% to 95% non-condensing.

Vibration

The LPQ200-M series power supply will pass the following vibration specifications:

Non-Operating Random Vibration

Acceleration	2.7	gRMS	
Frequency Range	10-2000	Hz	
Duration	20	mins	
Direction	3 mutually perpendicular axis		
PSD Profile	FREQ	SLOPE	PSD
	10-190 Hz	---	0.01 g ² /Hz
	190-210 Hz	-31.213dB/oct	---
	210-2000 Hz	---	0.003 g ² /Hz

Operating Random Vibration

Acceleration	1.0	gRMS	
Frequency Range	10-500	Hz	
Duration	20	mins	
Direction	3 mutually perpendicular axis		
PSD Profile	FREQ	SLOPE	PSD
	10-500 Hz	---	0.002 g ² /Hz

ENVIRONMENTAL SPECIFICATIONS

Shock

The LPQ200-M series power supply will pass the following vibration specifications

Non-Operating Half-Sine Shock

Acceleration	30	G
Duration	18	msec
Pulse	Half-Sine	
No. of Shock	3 shock on each of 6 faces	

Operating Half-Sine Shock

Acceleration	30	G
Duration	11	msec
Pulse	Half-Sine	
No. of Shock	3 shock on each of 6 faces	

POWER AND CONTROL SIGNAL DESCRIPTIONS

AC Input (SK1)

This connector supplies the AC Mains to the LPQ200-M series power supply.

Pin 1 - Neutral

Pin 3 - Line

Earth Ground (GND)

This tab connector is the safety ground connection and should be connected to AC input earth ground.

GND - Earth Ground (Safety Ground)

Main Output (SK2)

These terminals provide the main output for the LPQ200-M. The Vo and the Output Return terminals are the positive and negative rails, respectively of the main output of the LPQ200-M series power supply. The Main Output is electrically isolated from the Earth Ground and can be operated as a positive or negative output.

Pin 1 - V1 OUT

Pin 2 - V2 OUT

Pin 3 - GND OUT

Pin 4 - GND OUT

Pin 5 - GND OUT

Pin 6 - GND OUT

Pin 7 - V3 OUT

Pin 8 - V4 OUT

Vo Output voltage adjustment

Outputs on the Quad models outputs will be adjustable -20%, +10%, except for the 3V3 output which will be -15%, +10% and +24V output which will be -10%, +20%.

Control Signal (SK3)

The LPQ200-M series contains a 10 pins control signal header providing analogy control interface.

POWER AND CONTROL SIGNAL DESCRIPTIONS

Control Signal (SK3)

The LPQ200-M series contains a 10 pins control signal header providing analogy control interface.

+Remote Sense, -Remote Sense (Remote Sensing) – (SK3 – Pin1, 2, 9, 10)

The power supplies will provide remote sensing on the low voltage main output. It will compensate for up to 400 mV in each load line (800 mV in total). There will be reverse sense (to the their own output) and cross charging protection which will not cause damage to the power supply. This will be accomplished by using PTC pull up and pull down resistors to the main output. The output will remain in regulation regardless of sense configuration. The sensed output will not change by more than 1% between all sense configurations. The maximum terminal voltage under any operational condition will not exceed the maximum specified adjustment range terminal voltage when the unit is operating with local sensing (+20%) provided the total output power does not exceed the maximum rating.

N/C – (SK3 – Pin3, 4, 7)

GND- (SK3 – Pin6 and Pin8)

Power Fail – (SK3 – Pin5)

Power fail signal is an active low TTL signal capable of sinking 10ma maximum at 0.5VDC. This output is pulled-up to an internal 5V source and is common referenced. It goes high 100-500ms after the V1 output is in regulation.

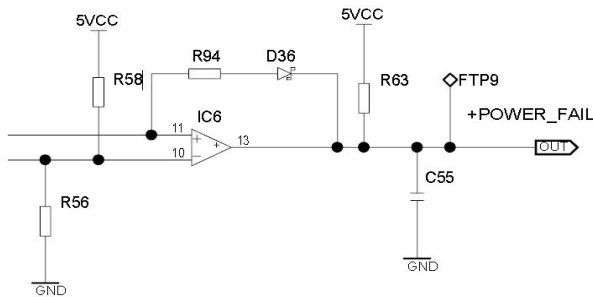

Power Fail signal output equivalent circuit

APPLICATION NOTES

Output Ripple and Noise Measurement

The setup outlined in the diagram below has been used for output voltage ripple and noise measurements on the LPQ200-M series. When measuring output ripple and noise, a scope jack in parallel with a 0.1µF ceramic chip capacitor, and a 10 µF aluminum electrolytic capacitor should be used. Oscilloscope should be set to 20 MHz bandwidth for this measurement.

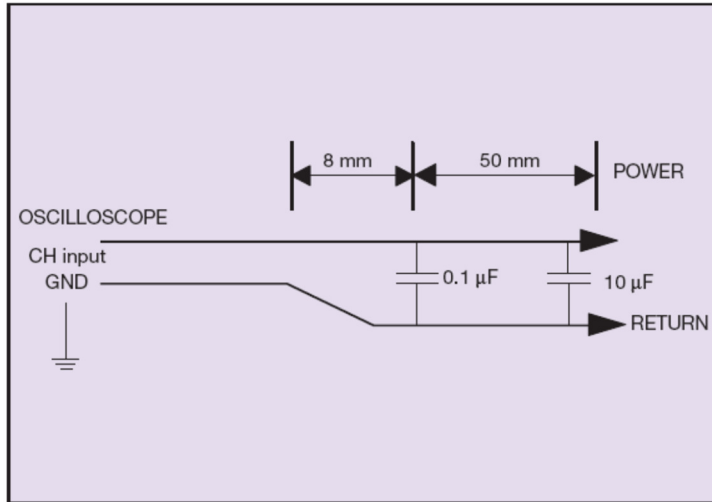

Block Diagram

Below is the block diagram of the LPQ200-M series power supply.

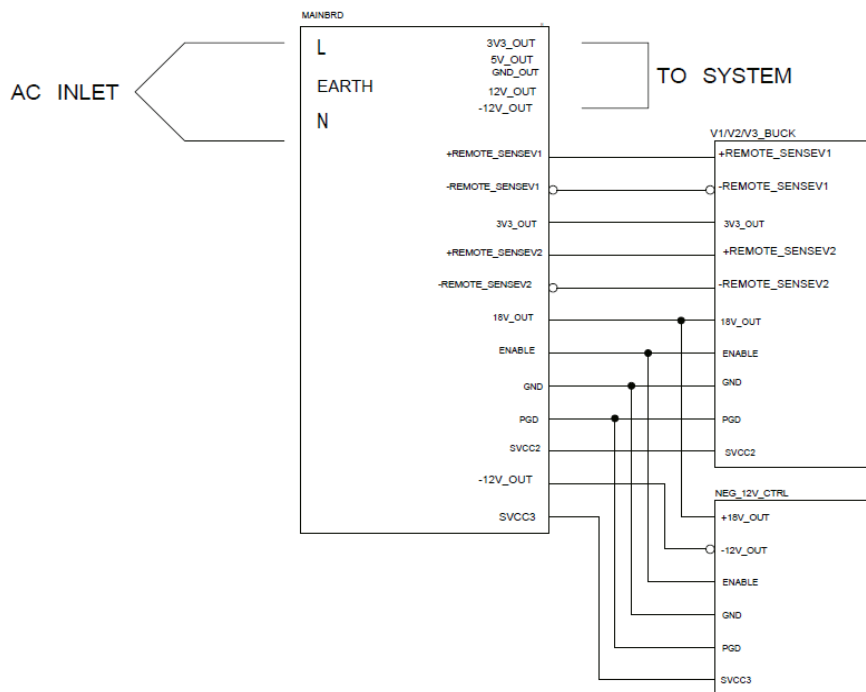

RECORD OF REVISION AND CHANGES

Issue	Date	Description	Originators
1.0	06.17.2014	First Issue	K. Wang
1.1	06.18.2020	Update 60950 to 62368-1	K. Wang



For international contact information,
visit advancedenergy.com.

powersale@aei.com (Sales Support)
productsupport.ep@aei.com (Technical Support)
+1 888 412 7832

ABOUT ADVANCED ENERGY

Advanced Energy (AE) has devoted more than three decades to perfecting power for its global customers. AE designs and manufactures highly engineered, precision power conversion, measurement and control solutions for mission-critical applications and processes.

Our products enable customer innovation in complex applications for a wide range of industries including semiconductor equipment, industrial, manufacturing, telecommunications, data center computing, and medical. With deep applications know-how and responsive service and support across the globe, we build collaborative partnerships to meet rapid technological developments, propel growth for our customers, and innovate the future of power.

PRECISION | POWER | PERFORMANCE

Specifications are subject to change without notice. Not responsible for errors or omissions. ©2020 Advanced Energy Industries, Inc. All rights reserved. Advanced Energy®, and AE® are U.S. trademarks of Advanced Energy Industries, Inc.