

# ARTESYN ASA 6W-M SERIES

## DC/DC Converter



### PRODUCT DESCRIPTION

Advanced Energy's Artesyn ASA 6W-M series are single and dual output DC/DC converter modules. The ASA 6W-M series DC/DC converters offer an economical solution for demanding applications in industrial and medical instrumentation requesting a certified high supplementary or reinforced insulation system to comply with relative industrial or medical safety standards. All models feature ultra-wide 2:1 input range with excellent output voltage regulation. The ASA 6W-M series can deliver up to 6W output power from the single or dual output module with high 80% typical efficiency and excellent thermal performance over an operating ambient temperature range of -40 °C ~ +75 °C.

### SPECIAL FEATURES

- 4000 Vac reinforced insulation
- Medical safety to UL/cUL/EN/IEC 60601-1 3rd Edition
- 2 MOOP rated
- Wide 2:1 input voltage range
- Fully regulated output voltage
- Low leakage current
- Operating temperature range -40 °C to +75 °C (with derating)
- Input filter meets EN 55022, class A and FCC, level A
- Overload protection
- 1.25" x 0.8" package
- RoHS compliant
- Three-year product warranty

### SAFETY

- cUL/UL62368-1, CSA C22.2 No. 62368-1-03
- UL60601-1, CSA C22.2 No.601-1
- IEC/EN 62368-1, IEC/EN 60601-1 3rd Edition, 2 MOOP
- cUL/UL62368-1 certificate
- UL60601-1 UL certificate

### TYPICAL APPLICATIONS

- Industrial
- Medical

### TECHNICAL REFERENCE NOTE

#### Total Power:

6 Watts

#### Input Voltage:

9-18 Vdc

18-36 Vdc

36-75 Vdc

#### # of Outputs:

Single / Dual



## Model Numbers

Model	Input Voltage	Output Voltage	Maximum Load	Efficiency
ASA01A12-M	9-18Vdc	5V	1A	75%
ASA001B12-M	9-18Vdc	12V	0.5A	78%
ASA01BB12-M	9-18Vdc	±12V	±0.25A	78%
ASA01CC12-M	9-18Vdc	±15V	±0.2A	78%
ASA01A24-M	18-36Vdc	5V	1A	77%
ASA01B24-M	18-36Vdc	12V	0.5A	80%
ASA01BB24-M	18-36Vdc	±12V	±0.25 A	80%
ASA01CC24-M	18-36Vdc	±15 V	±0.2 A	80%
ASA01A48-M	36-75 Vdc	5V	1A	77%
ASA01B48-M	36-75 Vdc	12V	0.5A	80%
ASA01BB48-M	36-75 Vdc	±12V	±0.25A	80%
ASA01CC48-M	36-75 Vdc	±15V	±0.2A	80%

## Electrical Specifications

### Absolute Maximum Ratings

Stress in excess of those listed in the “Absolute Maximum Ratings” may cause permanent damage to the power supply. These are stress ratings only and functional operation of the unit is not implied at these or any other conditions above those given in the operational sections of this TRN. Exposure to any absolute maximum rated condition for extended periods may adversely affect the power supply’s reliability.

Table 1. Absolute Maximum Ratings						
Parameter	Model	Symbol	Min	Typ	Max	Unit
Input Voltage Operating -Continuous	12V input Models	$V_{IN,DC}$	9	-	18	Vdc
	24V input Models		18	-	36	
	48V input Models		36	-	75	
Maximum Output Power	All models	$P_{O,max}$	-	-	6	W
Isolation Voltage Input to output	All models		4000	-	-	Vac
Isolation Resistance 500Vdc	All models		10	-	-	Gohm
Isolation Capacitance 100KHz, 1V	All models		-	7	13	pF
Operating Ambient Temperature With Derating Without Derating	All models	$T_A$	-40	-	+75	°C
	All models		-40	-	+55	°C
Operating Case Temperature	All models	$T_{CASE}$	-40	-	+95	°C
Storage Temperature	All models	$T_{STG}$	-50	-	+125	°C
Humidity (non-condensing) Operating Non-operating	All models		-	-	95	%
	All models		-	-	95	%

## Electrical Specifications

### Input Specifications

Table 2. Input Specifications							
Parameter		Condition	Symbol	Min	Typ	Max	Unit
Operating Input Voltage, DC	12V input Models 24V input Models 48V input Models	All	$V_{IN,DC}$	9 18 36	- - -	18 36 75	Vdc
Input Surge Voltage	12V input Models 24V input Models 48V input Models	1 sec, max	$V_{IN,surge}$	-0.7 -0.7 -0.7	- - -	25 50 100	Vdc
Start-up Threshold Voltage	12V input Models 24V Input Models 48V Input Models	All	$V_{IN,ON}$	7 13 30	8 15 33	9 18 36	Vdc
Under Voltage Shutdown	12V input Models 24V Input Models 48V Input Models	All	$V_{IN,OFF}$	- - -	- - -	8.5 16 34	Vdc
Input reflected ripple current	12V input Models 24V Input Models 48V Input Models	20MHz, Measure with a inductor 4.7 $\mu$ H and Capacitance 220 $\mu$ F	$I_{IN,ripple}$	- - -	60 30 15	- - -	mA
Input Current	ASA01A12-M ASA001B12-M ASA01BB12-M ASA01CC12-M ASA01A24-M ASA01B24-M ASA01BB24-M ASA01CC24-M ASA01A48-M ASA01B48-M ASA01BB48-M ASA01CC48-M	$V_{IN,DC}=V_{IN,nom}$	$I_{IN,full\ load}$	- - - - - - - - - - - -	570 641 641 641 278 313 313 313 139 156 156 156	- - - - - - - - - - - -	mA
No Load Input Current ( $V_o = On, I_o = 0A$ )	ASA01A12-M ASA001B12-M ASA01BB12-M ASA01CC12-M ASA01A24-M ASA01B24-M ASA01BB24-M ASA01CC24-M ASA01A48-M ASA01B48-M ASA01BB48-M ASA01CC48-M	$V_{IN,DC}=V_{IN,nom}$	$I_{IN,no-load}$	- - - - - - - - - - - -	30 30 30 30 20 20 20 20 10 10 10 10	- - - - - - - - - - - -	mA

## Electrical Specifications

### Input Specifications

Table 2. Input Specifications con't							
Parameter		Condition	Symbol	Min	Typ	Max	Unit
Efficiency	ASA01A12-M	$V_{IN,DC} = V_{IN,nom}$ $I_O = I_{O,max}$ $T_A = 25\text{ }^{\circ}\text{C}$	$\eta$	-	75	-	%
	ASA001B12-M			-	78	-	
	ASA01BB12-M			-	78	-	
	ASA01CC12-M			-	78	-	
	ASA01A24-M			-	77	-	
	ASA01B24-M			-	80	-	
	ASA01BB24-M			-	80	-	
	ASA01CC24-M			-	80	-	
	ASA01A48-M			-	77	-	
	ASA01B48-M			-	80	-	
	ASA01BB48-M			-	80	-	
ASA01CC48-M	-	80	-				
MTBF	MIL-STD-217F, $T_A = 25\text{ }^{\circ}\text{C}$	All		1000	-	-	K Hours

## Electrical Specifications

### Output Specifications

Table 3. Output Specifications							
Parameter		Condition	Symbol	Min	Typ	Max	Unit
Output Voltage Set-Point	ASA01A12-M	$V_{IN,DC} = V_{IN,nom}$ $I_O = I_{O,max}$ $T_A = 25\text{ }^{\circ}\text{C}$	$V_O$	4.95	5	5.05	Vdc
	ASA001B12-M			11.88	12	12.12	
	ASA01BB12-M			$\pm 11.88$	$\pm 12$	$\pm 12.12$	
	ASA01CC12-M			$\pm 14.85$	$\pm 15$	$\pm 15.15$	
	ASA01A24-M			4.95	5	5.05	
	ASA01B24-M			11.88	12	12.12	
	ASA01BB24-M			$\pm 11.88$	$\pm 12$	$\pm 12.12$	
	ASA01CC24-M			$\pm 14.85$	$\pm 15$	$\pm 15.15$	
	ASA01A48-M			4.95	5	5.05	
	ASA01B48-M			11.88	12	12.12	
	ASA01BB48-M			$\pm 11.88$	$\pm 12$	$\pm 12.12$	
	ASA01CC48-M			$\pm 14.85$	$\pm 15$	$\pm 15.15$	
	Output Current			ASA01A12-M	Convection cooling	$I_O$	
ASA001B12-M		-	-	0.5			
ASA01BB12-M		-	-	0.25			
ASA01CC12-M		-	-	0.2			
ASA01A24-M		-	-	1			
ASA01B24-M		-	-	0.5			
ASA01BB24-M		-	-	0.25			
ASA01CC24-M		-	-	0.2			
ASA01A48-M		-	-	1			
ASA01B48-M		-	-	0.5			
ASA01BB48-M		-	-	0.25			
ASA01CC48-M		-	-	0.2			
$V_O$ Load Capacitance		ASA01A12-M	All				-
	ASA001B12-M	-			-	470	
	ASA01BB12-M	-			-	220#	
	ASA01CC12-M	-			-	220#	
	ASA01A24-M	-			-	1000	
	ASA01B24-M	-			-	470	
	ASA01BB24-M	-			-	220#	
	ASA01CC24-M	-			-	220#	
	ASA01A48-M	-			-	1000	
	ASA01B48-M	-			-	470	
	ASA01BB48-M	-			-	220#	
	ASA01CC48-M	-			-	220#	

## Electrical Specifications

### Output Specifications

Table 3. Output Specifications Con't						
Parameter	Condition	Symbol	Min	Typ	Max	Unit
Output Ripple, pk-pk 5V Output Models Other Output Models	20MHz bandwidth, measured with a 1uF MLCC and a 10uF Tantalum Capacitor	$V_O$	-	75	100	mV
		$V_O$	-	100	150	mV
Line Regulation	$V_{IN,DC} = V_{IN,min}$ to $V_{IN,max}$	$\pm\%V_O$	-	0.3	0.5	%
Load Regulation	$I_O = 25\%I_{O,max}$ to $I_{O,max}$	$\pm\%V_O$	-	0.5	1.0	%
$V_O$ Dynamic Response Peak Deviation Settling Time	25% load change, slew rate = 1A/uS	$\pm\%V_O$	-	3	6	%
		$t_s$	-	300	500	uSec
Temperature Coefficient	All	$\%/^{\circ}C$	-	0.02	0.05	%
Switching Frequency	All	$f_{SW}$	-	150	-	KHz
Output Over Current Protection	All		120	150	-	$\%I_{O,max}$
Output Short Circuit Protection	All		Continuous			

# Electrical Specifications

## ASA01A12-M Performance Curves

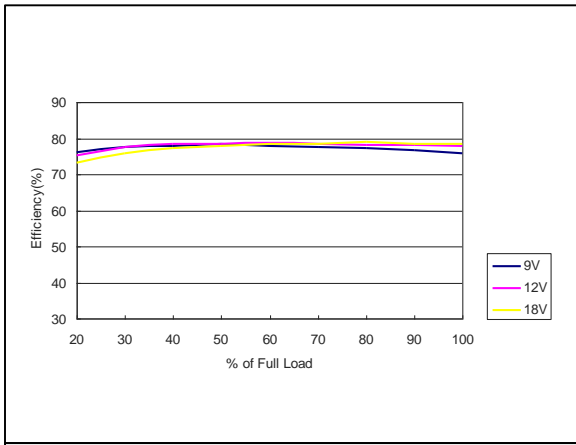

Figure 1: ASA01A12-M Efficiency Versus Output Current Curve  
 Vin = 9 to 18Vdc Load: Io = 0 to 1A

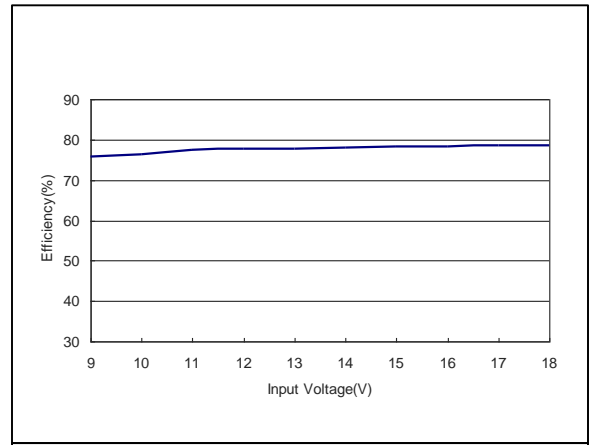

Figure 2: ASA01A12-M Efficiency Versus Input Voltage Curve  
 Vin = 9 to 18Vdc Load: Io = 1A

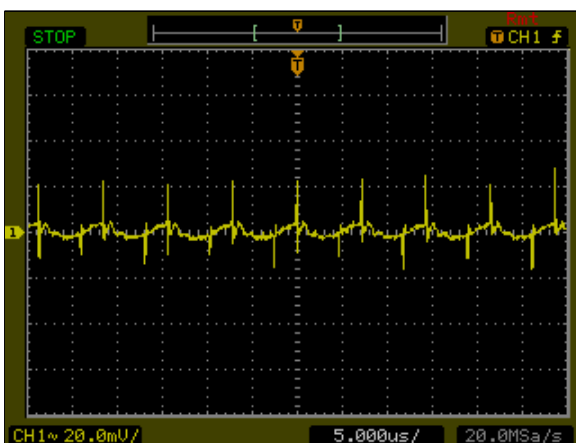

Figure 3: ASA01A12-M Ripple and Noise Measurement  
 Vin = 12Vdc Load: Io = 1A  
 Ch 1: Vo

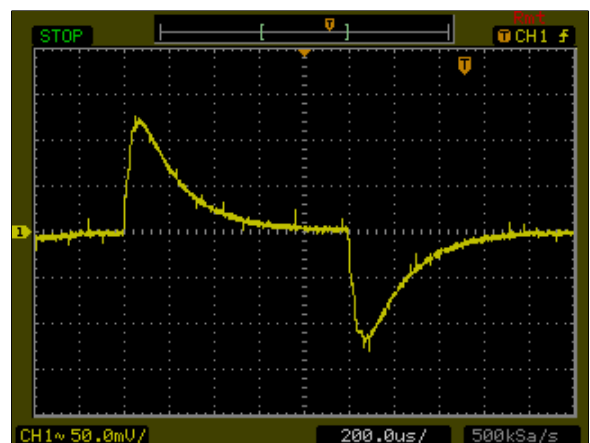

Figure 4: ASA01A12-M Transient Response  
 Vin = 12Vdc Load: Io = 100% to 75% load change  
 Ch 1: Vo

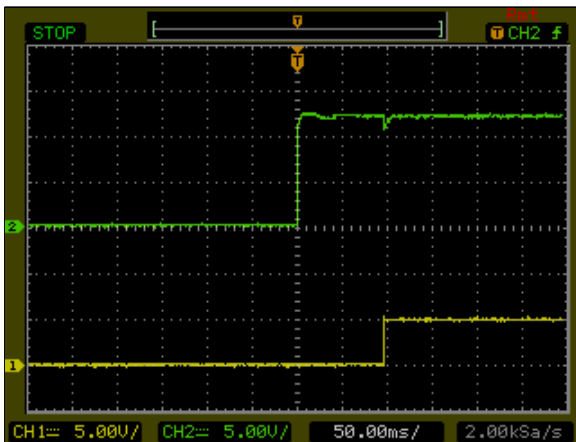

Figure 5: ASA01A12-M Output Voltage Startup Characteristic by Vin  
 Vin = 12Vdc Load: Io = 1A  
 Ch 1: Vin Ch 2: Vo

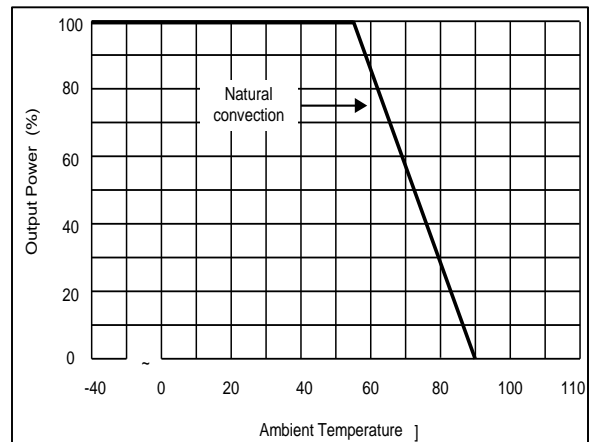

Figure 6: ASA01A12-M Output Current Versus Ambient Temperature  
 Vin = 12Vdc Load: Io = 1A



# Electrical Specifications

## ASA01A12-M Performance Curves

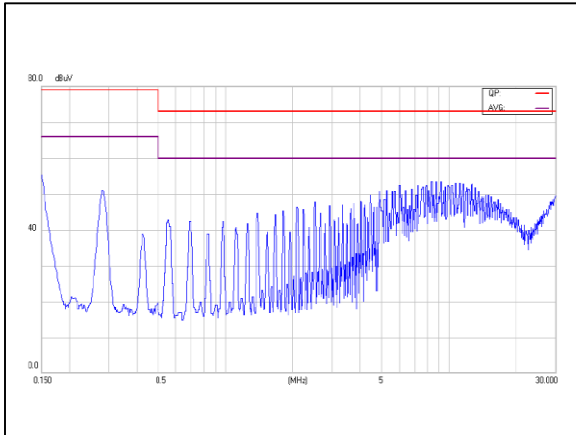

Figure 7: ASA01A12-M Conduction Emission of EN55022 Class A  
 Vin = 12Vdc Load: Io = 1A

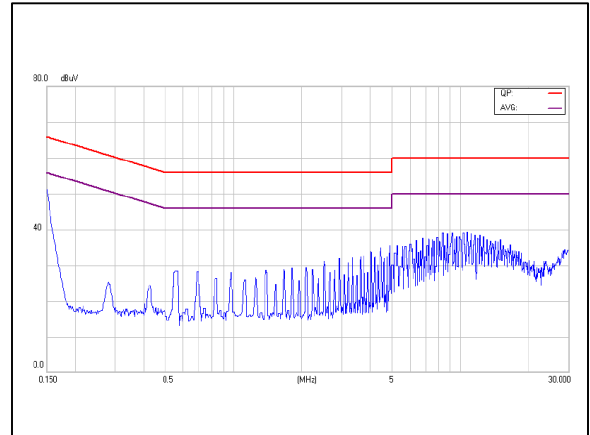

Figure 8: ASA01A12-M Conduction Emission of EN55022 Class B  
 Vin = 12Vdc Load: Io = 1A

Note - All test conditions are at 25 °C

# Electrical Specifications

## ASA001B12-M Performance Curves

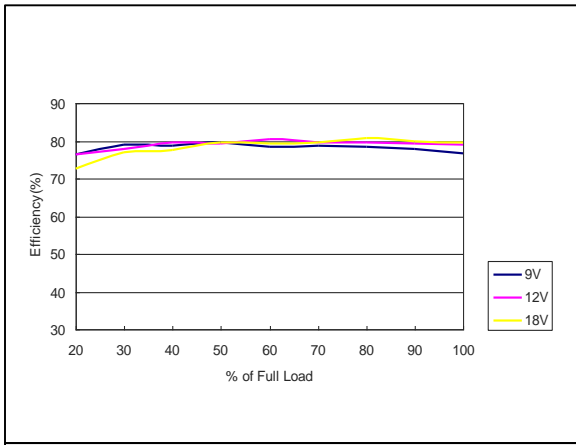

Figure 9: ASA001B12-M Efficiency Versus Output Current Curve  
 Vin = 9 to 18Vdc Load: Io = 0 to 0.5A

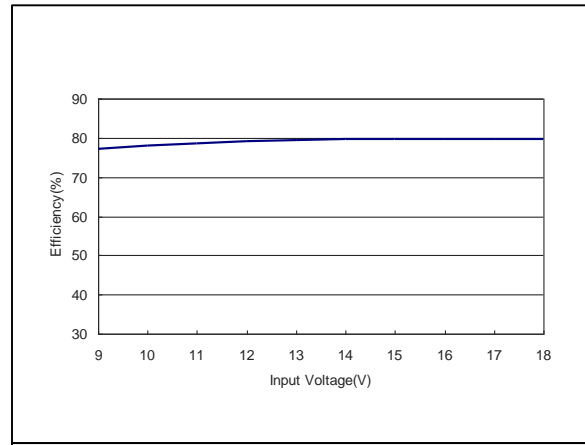

Figure 10: ASA001B12-M Efficiency Versus Input Voltage Curve  
 Vin = 9 to 18Vdc Load: Io = 0.5A

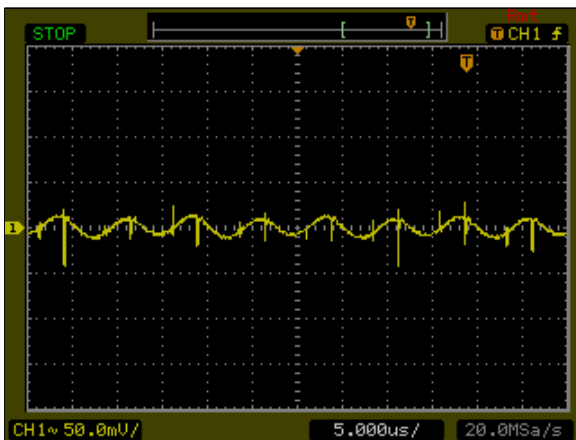

Figure 11: ASA001B12-M Ripple and Noise Measurement  
 Vin = 12Vdc Load: Io = 0.5A  
 Ch 1: Vo

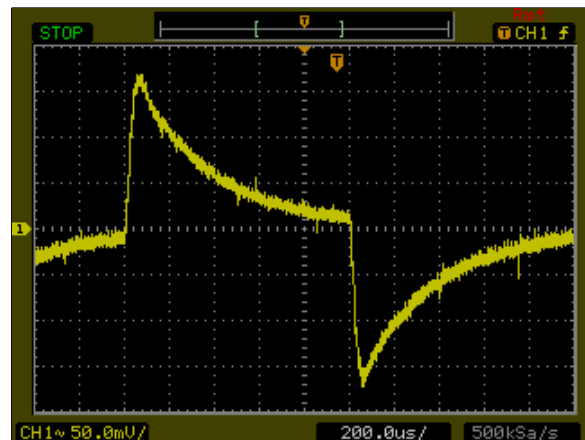

Figure 12: ASA001B12-M Transient Response  
 Vin = 12Vdc Load: Io = 100% to 75% load change  
 Ch 1: Vo

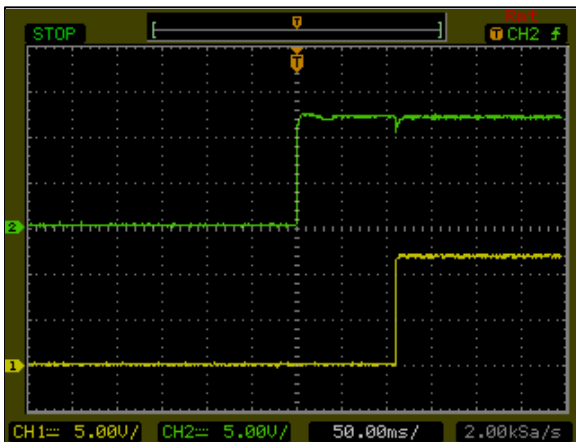

Figure 13: ASA001B12-M Output Voltage Startup Characteristic by Vin  
 Vin = 12Vdc Load: Io = 0.5A  
 Ch 1: Vin Ch 2: Vo

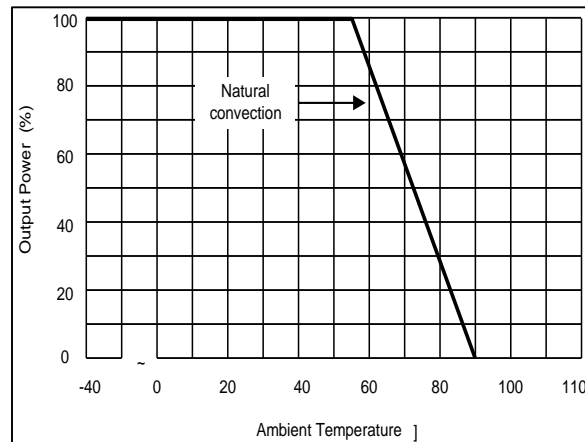

Figure 14: ASA001B12-M Output Current Versus Ambient Temperature  
 Vin = 12Vdc Load: Io = 0.5A

## Electrical Specifications

### ASA001B12-M Performance Curves

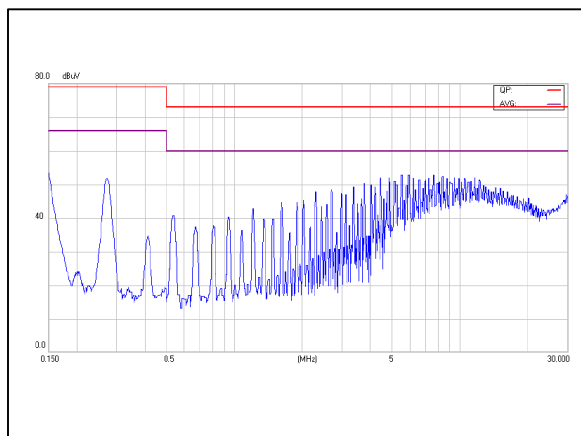

Figure 15: ASA001B12-M Conduction Emission of EN55022 Class A  
 Vin = 12Vdc Load: Io = 0.5A

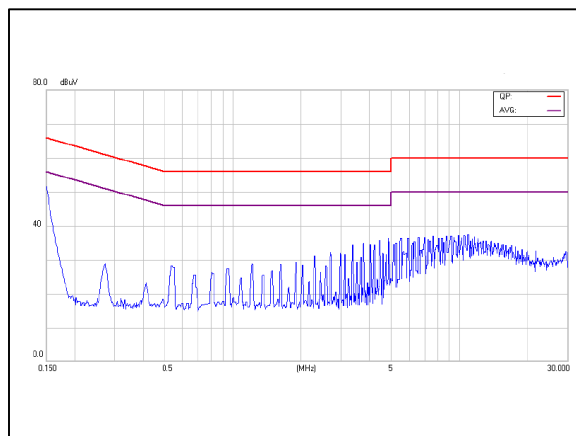

Figure 16: ASA001B12-M Conduction Emission of EN55022 Class B  
 Vin = 12Vdc Load: Io = 0.5A

Note - All test conditions are at 25 °C

# Electrical Specifications

## ASA01BB12-M Performance Curves

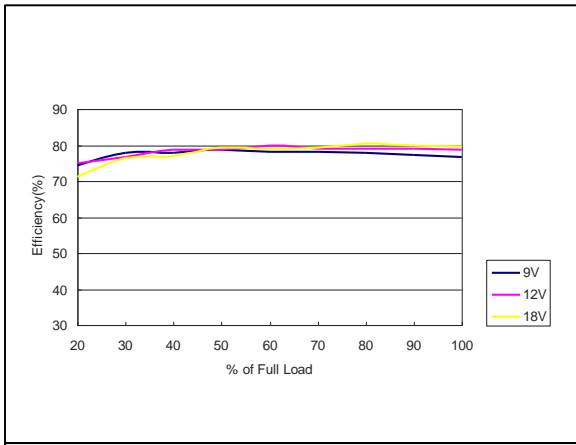

Figure 17: ASA01BB12-M Efficiency Versus Output Current Curve  
 Vin = 9 to 18Vdc Load: Io = 0 to ± 0.25A

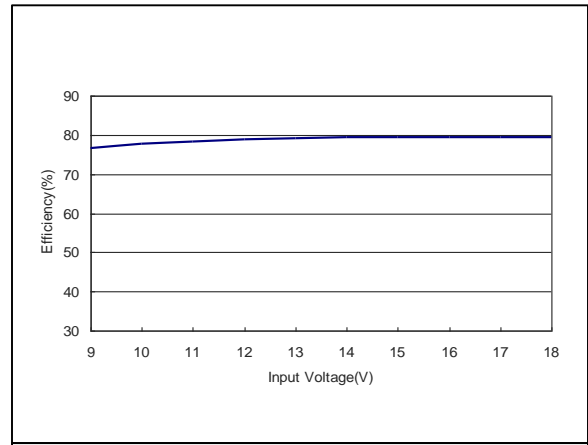

Figure 18: ASA01BB12-M Efficiency Versus Input Voltage Curve  
 Vin = 9 to 18Vdc Load: Io = ± 0.25A

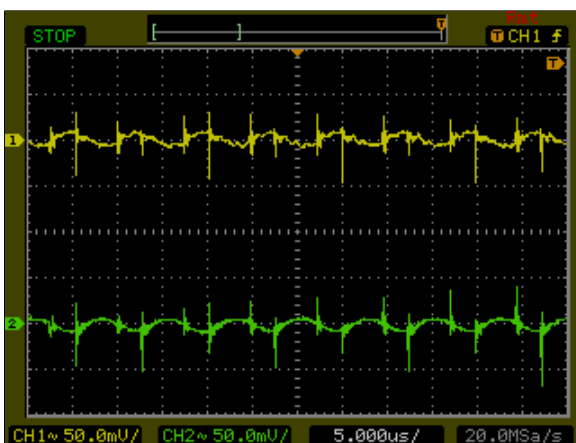

Figure 19: ASA01BB12-M Ripple and Noise Measurement  
 Vin = 12Vdc Load: Io = ± 0.25A  
 Ch 1: Vout1 Ch 2: Vout2

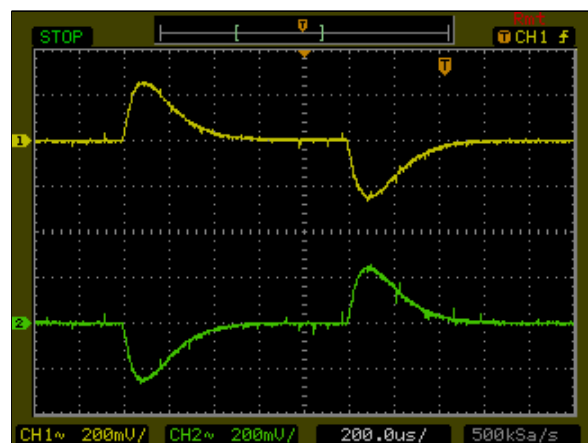

Figure 20: ASA01BB12-M Transient Response  
 Vin = 12Vdc Load: Io = 100% to 75% load change  
 Ch 1: Vout1 Ch 2: Vout2

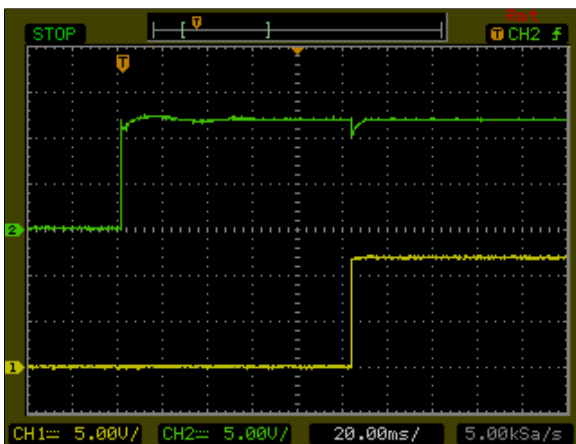

Figure 21: ASA01BB12-M Output Voltage Startup Characteristic by Vin  
 Vin = 12Vdc Load: Io = ± 0.25A  
 Ch 1: Vin Ch 2: Vo

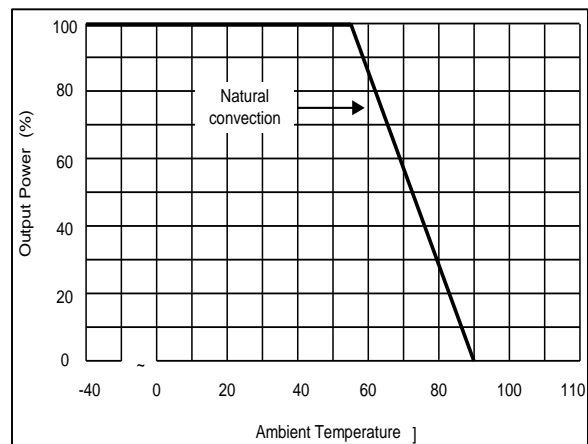

Figure 22: ASA01BB12-M Output Current Versus Ambient Temperature  
 Vin = 12Vdc Load: Io = ± 0.25A

## Electrical Specifications

### ASA01BB12-M Performance Curves

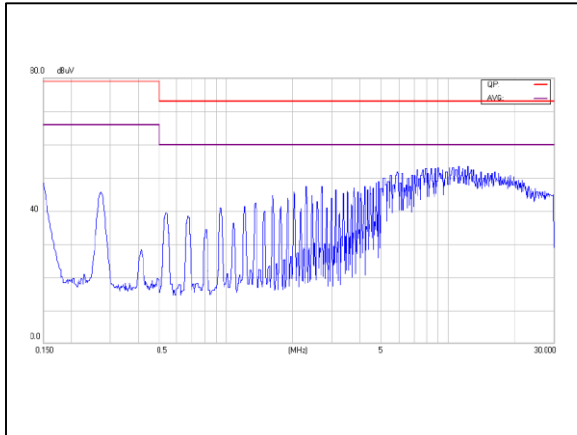

Figure 23: ASA01BB12-M Conduction Emission of EN55022 Class A  
 Vin = 12Vdc Load: Io = ± 0.25A

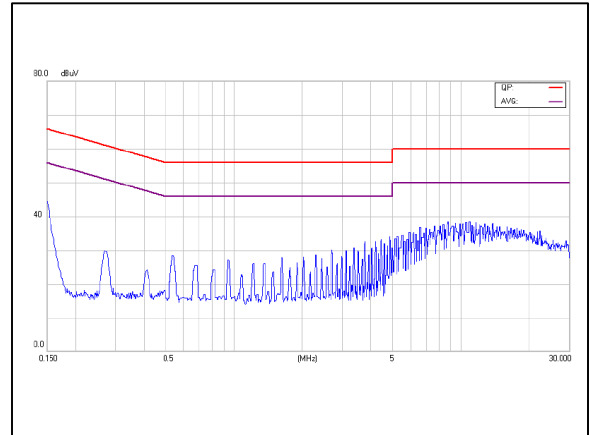

Figure 24: ASA01BB12-M Conduction Emission of EN55022 Class B  
 Vin = 12Vdc Load: Io = ± 0.25A

Note - All test conditions are at 25 °C

# Electrical Specifications

## ASA01CC12-M Performance Curves

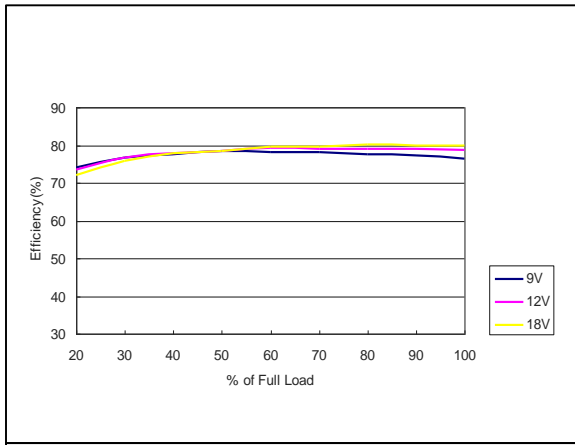

Figure 25: ASA01CC12-M Efficiency Versus Output Current Curve  
 Vin = 9 to 18Vdc Load: Io = 0 to ± 0.2A

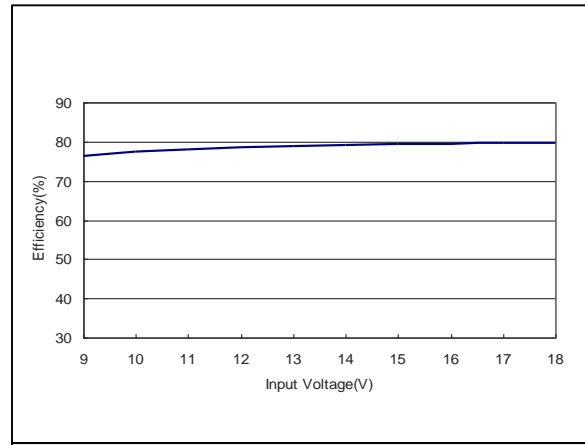

Figure 26: ASA01CC12-M Efficiency Versus Input Voltage Curve  
 Vin = 9 to 18Vdc Load: Io = ± 0.2A

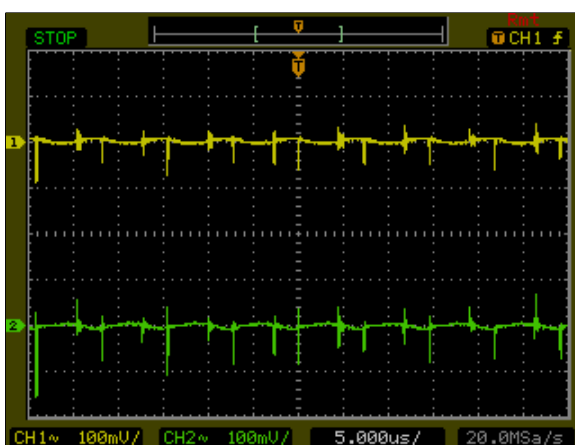

Figure 27: ASA01CC12-M Ripple and Noise Measurement  
 Vin = 12Vdc Load: Io = ± 0.2A  
 Ch 1: Vout1 Ch 2: Vout2

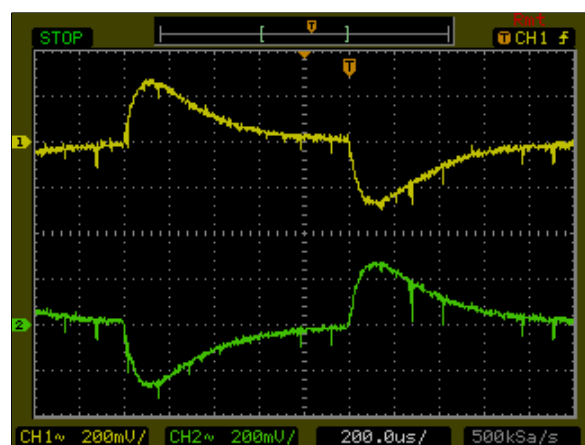

Figure 28: ASA01CC12-M Transient Response  
 Vin = 12Vdc Load: Io = 100% to 75% load change  
 Ch 1: Vout1 Ch 2: Vout2

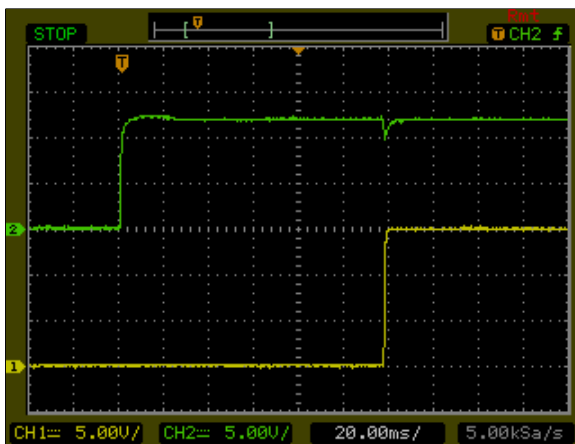

Figure 29: ASA01CC12-M Output Voltage Startup Characteristic by Vin  
 Vin = 12Vdc Load: Io = ± 0.2A  
 Ch 1: Vin Ch 2: Vo

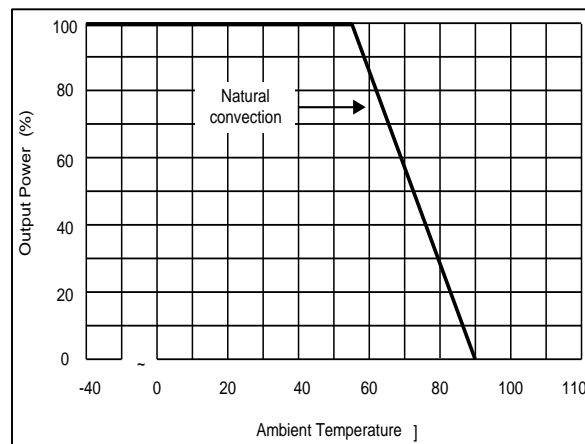

Figure 30: ASA01CC12-M Output Current Versus Ambient Temperature  
 Vin = 12Vdc Load: Io = ± 0.2A

## Electrical Specifications

### ASA01CC12-M Performance Curves

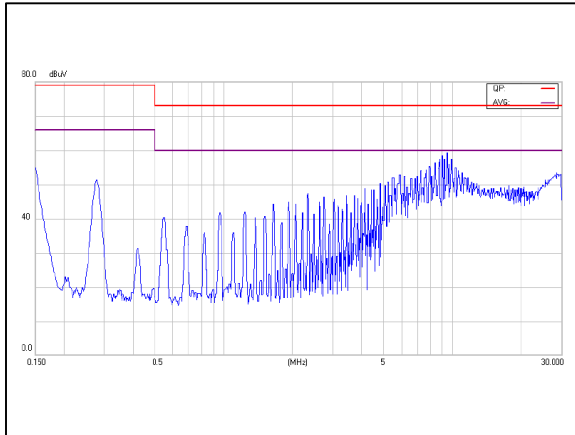

Figure 31: ASA01CC12-M Conduction Emission of EN55022 Class A  
 Vin = 12Vdc Load: Io = ± 0.2A

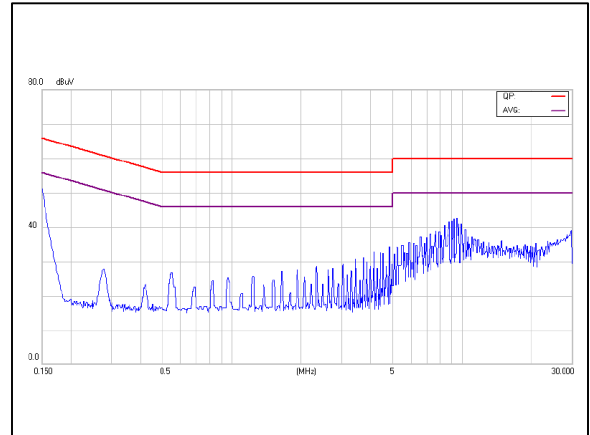

Figure 32: ASA01CC12-M Conduction Emission of EN55022 Class B  
 Vin = 12Vdc Load: Io = ± 0.2A

Note - All test conditions are at 25 °C

# Electrical Specifications

## ASA01A24-M Performance Curves

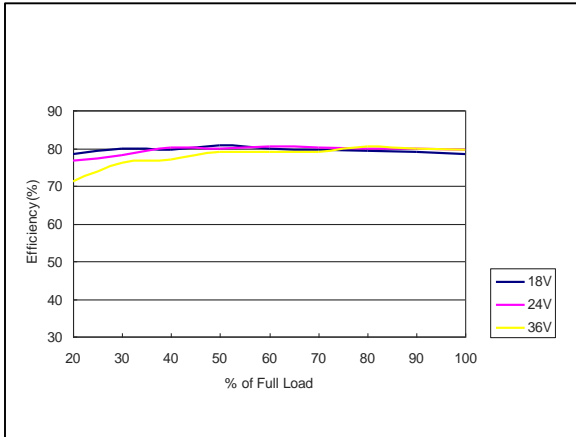

Figure 33: ASA01A24-M Efficiency Versus Output Current Curve  
 Vin = 18 to 36Vdc Load: Io = 0 to 1A

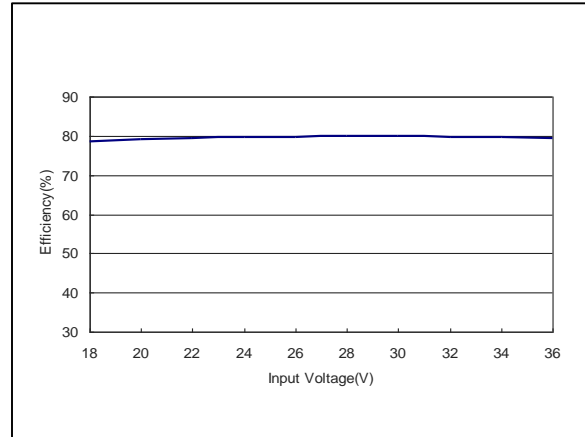

Figure 34: ASA01A24-M Efficiency Versus Input Voltage Curve  
 Vin = 18 to 36Vdc Load: Io = 1A

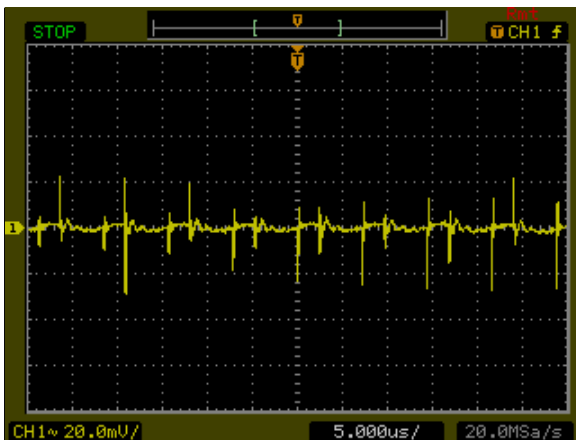

Figure 35: ASA01A24-M Ripple and Noise Measurement  
 Vin = 24Vdc Load: Io = 1A  
 Ch 1: Vo

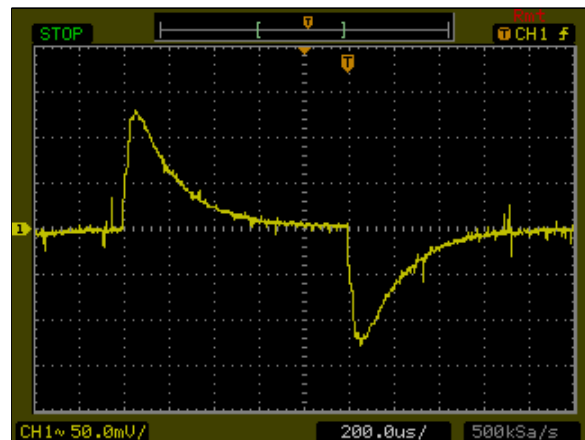

Figure 36: ASA01A24-M Transient Response  
 Vin = 24Vdc Load: Io = 100% to 75% load change  
 Ch 1: Vo

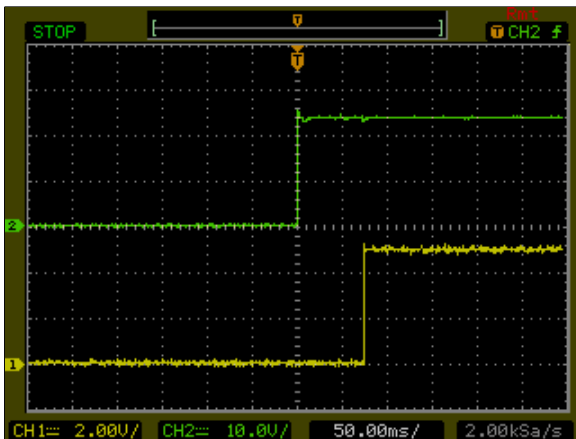

Figure 37: ASA01A24-M Output Voltage Startup Characteristic by Vin  
 Vin = 24Vdc Load: Io = 1A  
 Ch 1: Vin Ch 2: Vo

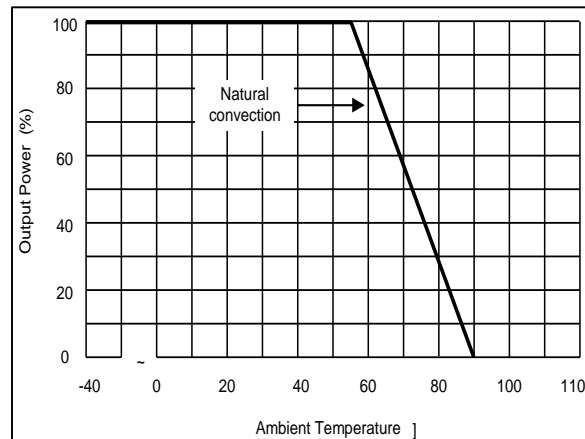

Figure 38: ASA01A24-M Output Current Versus Ambient Temperature  
 Vin = 24Vdc Load: Io = 1A



## Electrical Specifications

### ASA01A24-M Performance Curves

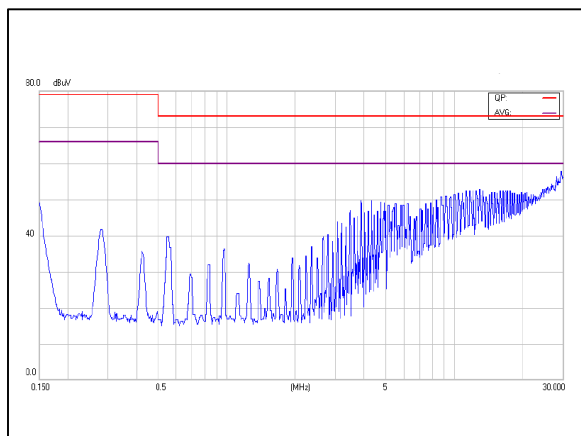

Figure 39: ASA01A24-M Conduction Emission of EN55022 Class A  
 Vin = 24Vdc Load: Io = 1A

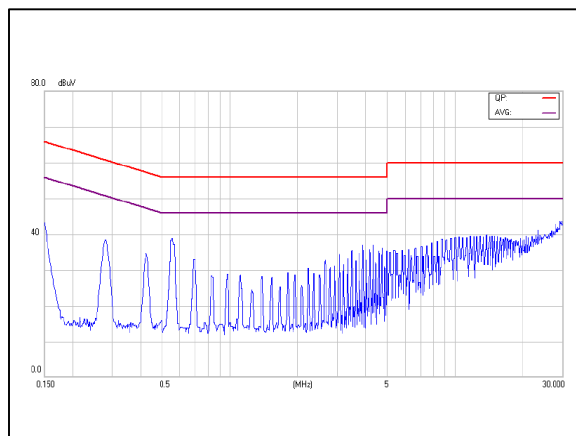

Figure 40: ASA01A24-M Conduction Emission of EN55022 Class B  
 Vin = 24Vdc Load: Io = 1A

Note - All test conditions are at 25 °C

# Electrical Specifications

## ASA01B24-M Performance Curves

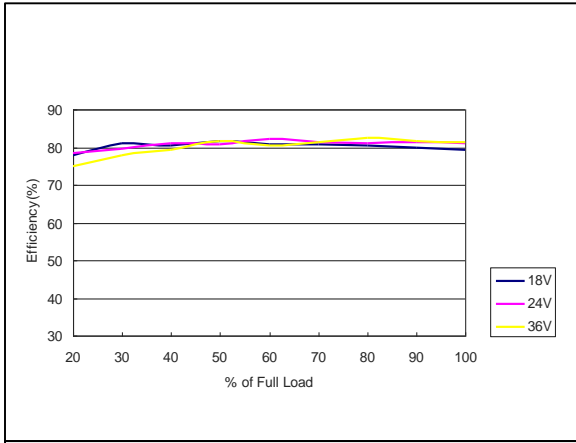

Figure 41: ASA01B24-M Efficiency Versus Output Current Curve  
 Vin = 18 to 36Vdc Load: Io = 0 to 0.5A

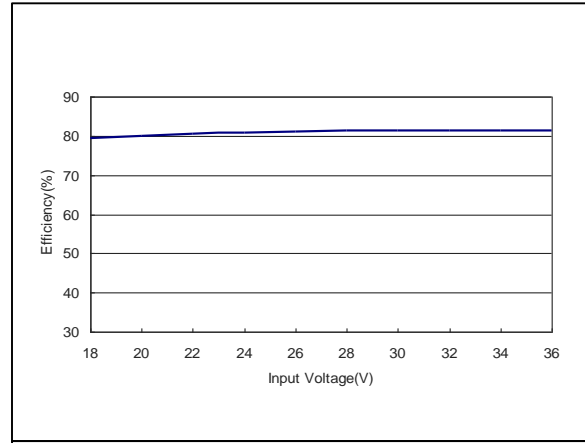

Figure 42: ASA01B24-M Efficiency Versus Input Voltage Curve  
 Vin = 18 to 36Vdc Load: Io = 0.5A

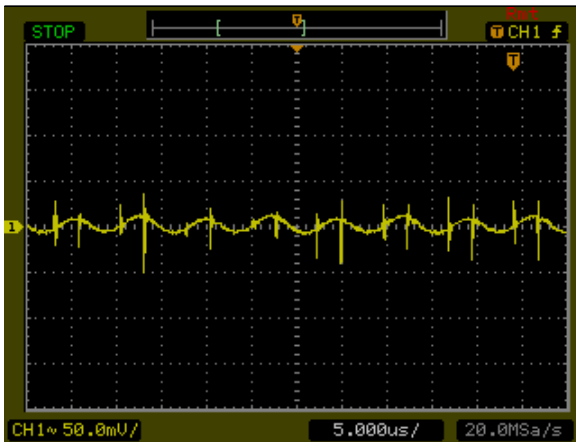

Figure 43: ASA01B24-M Ripple and Noise Measurement  
 Vin = 24Vdc Load: Io = 0.5A  
 Ch 1: Vo

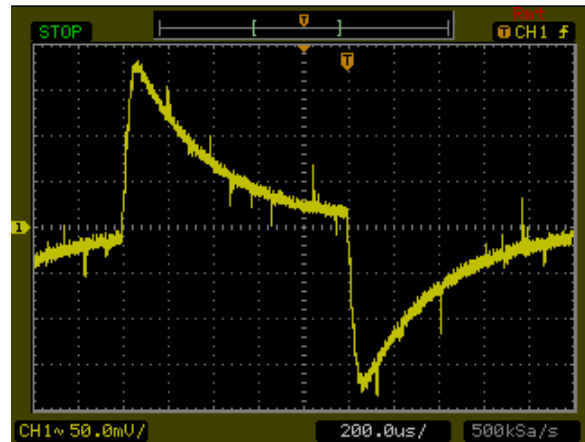

Figure 44: ASA01B24-M Transient Response  
 Vin = 24Vdc Load: Io = 100% to 75% load change  
 Ch 1: Vo

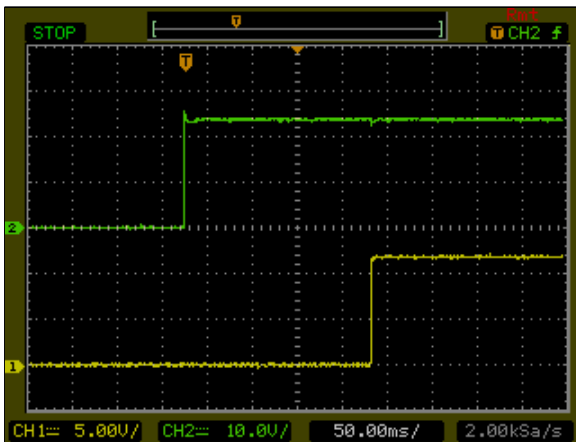

Figure 45: ASA01B24-M Output Voltage Startup Characteristic by Vin  
 Vin = 24Vdc Load: Io = 0.5A  
 Ch 1: Vin Ch 2: Vo

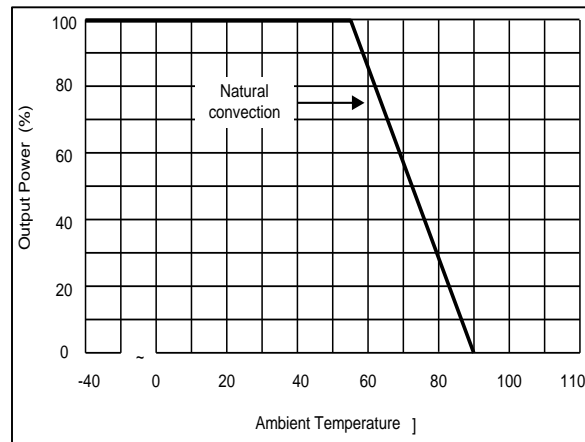

Figure 46: ASA01B24-M Output Current Versus Ambient Temperature  
 Vin = 24Vdc Load: Io = 0.5A

## Electrical Specifications

### ASA01B24-M Performance Curves

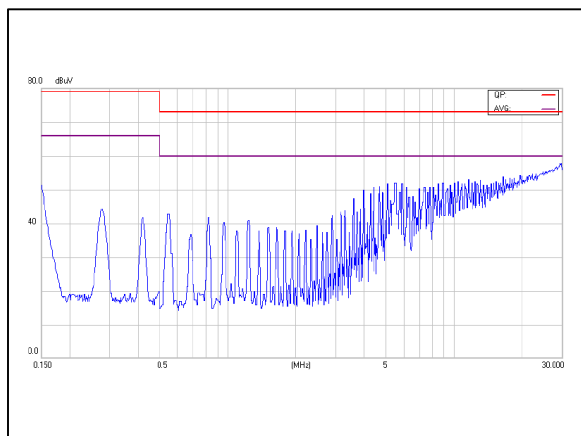

Figure 47: ASA01B24-M Conduction Emission of EN55022 Class A  
 Vin = 24Vdc Load: Io = 0.5A

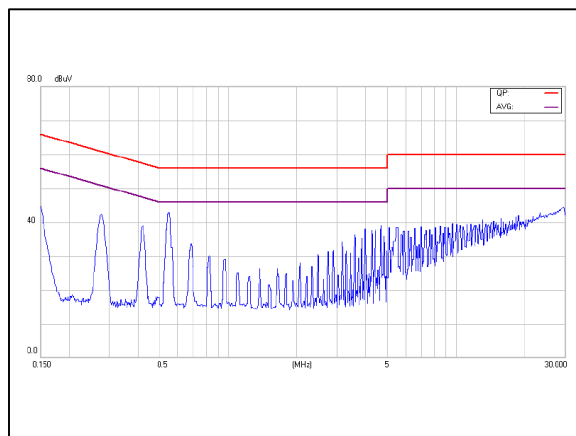

Figure 48: ASA01B24-M Conduction Emission of EN55022 Class B  
 Vin = 24Vdc Load: Io = 0.5A

Note - All test conditions are at 25 °C

# Electrical Specifications

## ASA01BB24-M Performance Curves

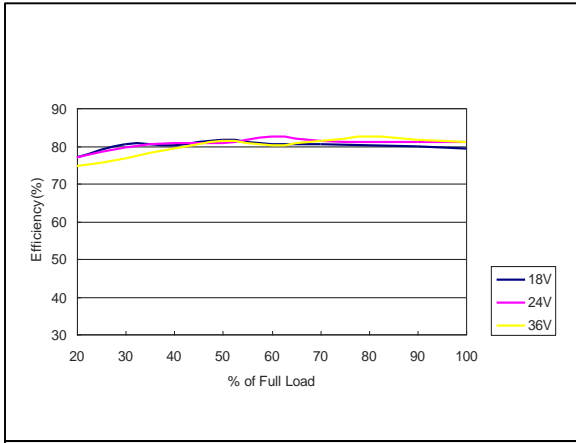

Figure 49: ASA01BB24-M Efficiency Versus Output Current Curve  
 Vin = 18 to 36Vdc Load: Io = 0 to ± 0.25A

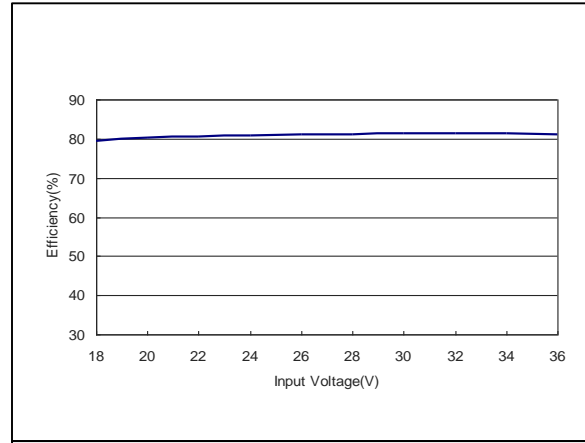

Figure 50: ASA01BB24-M Efficiency Versus Input Voltage Curve  
 Vin = 18 to 36Vdc Load: Io = ± 0.25A

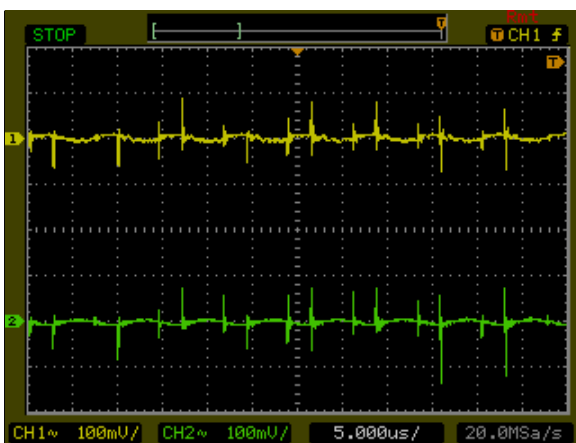

Figure 51: ASA01BB24-M Ripple and Noise Measurement  
 Vin = 24Vdc Load: Io = ± 0.25A  
 Ch 1: Vout1 Ch 2: Vout2

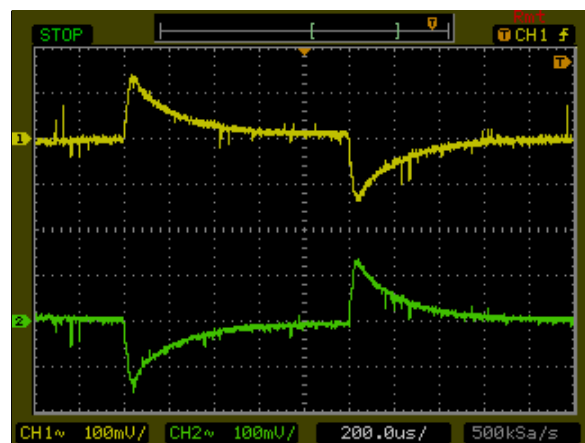

Figure 52: ASA01BB24-M Transient Response  
 Vin = 24Vdc Load: Io = 100% to 75% load change  
 Ch 1: Vout1 Ch 2: Vout2

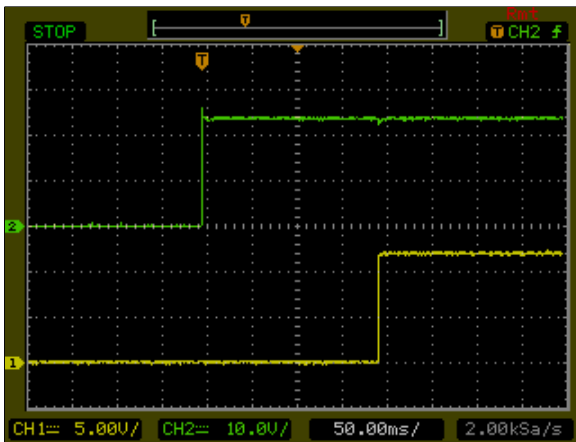

Figure 53: ASA01BB24-M Output Voltage Startup Characteristic by Vin  
 Vin = 24Vdc Load: Io = ± 0.25A  
 Ch 1: Vin Ch 2: Vo

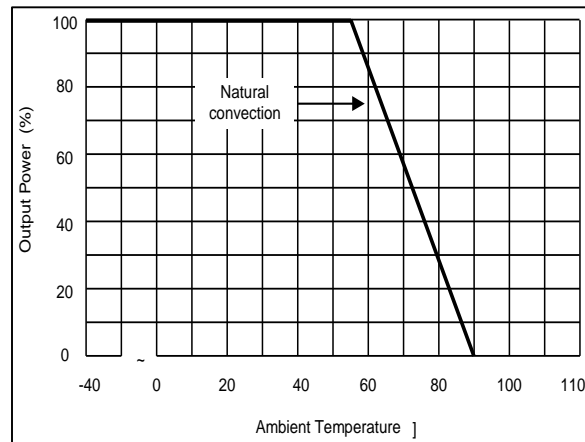

Figure 54: ASA01BB24-M Output Current Versus Ambient Temperature  
 Vin = 24Vdc Load: Io = ± 0.25A

# Electrical Specifications

## ASA01BB24-M Performance Curves

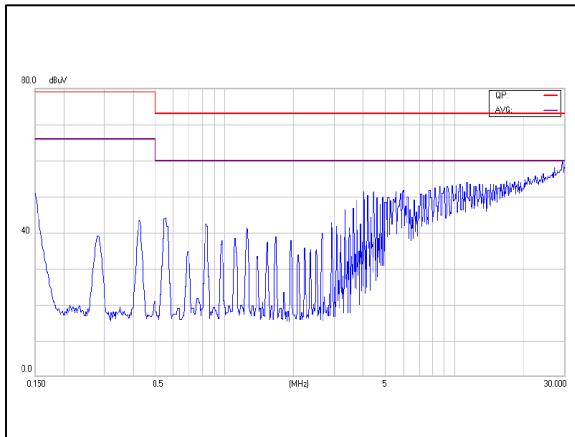

Figure 55: ASA01BB24-M Conduction Emission of EN55022 Class A  
 Vin = 24Vdc Load: Io = ± 0.25A

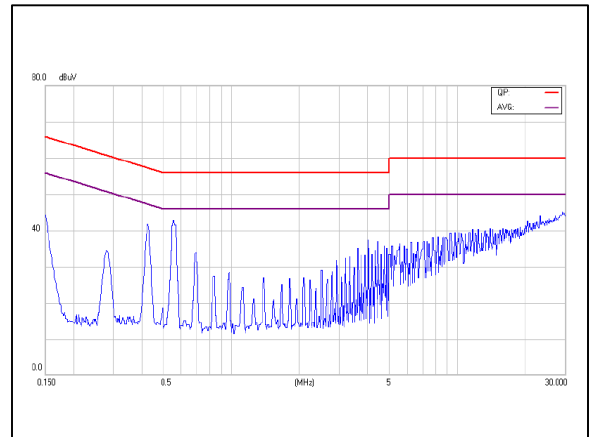

Figure 56: ASA01BB24-M Conduction Emission of EN55022 Class B  
 Vin = 24Vdc Load: Io = ± 0.25A

Note - All test conditions are at 25 °C

# Electrical Specifications

## ASA01CC24-M Performance Curves

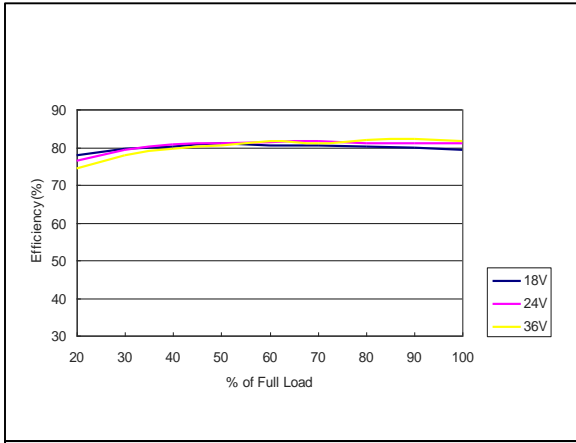

Figure 57: ASA01CC24-M Efficiency Versus Output Current Curve  
 Vin = 18 to 36Vdc Load: Io = 0 to ± 0.2A

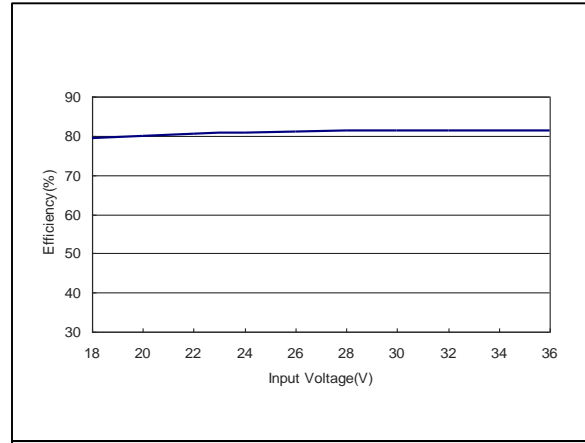

Figure 58: ASA01CC24-M Efficiency Versus Input Voltage Curve  
 Vin = 18 to 36Vdc Load: Io = ± 0.2A

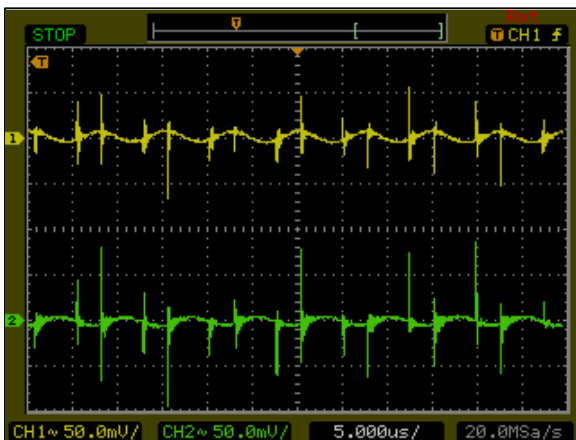

Figure 59: ASA01CC24-M Ripple and Noise Measurement  
 Vin = 24Vdc Load: Io = ± 0.2A  
 Ch 1: Vout1 Ch 2: Vout2

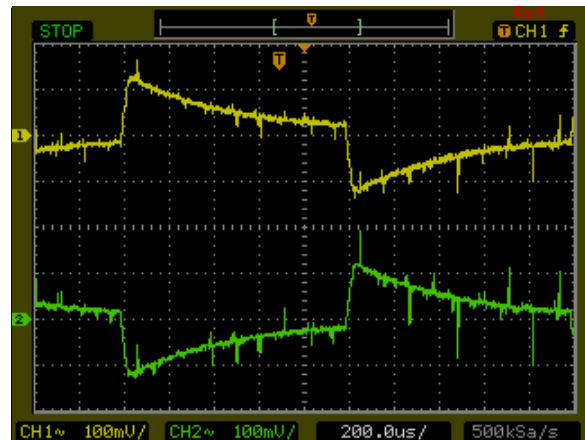

Figure 60: ASA01CC24-M Transient Response  
 Vin = 24Vdc Load: Io = 100% to 75% load change  
 Ch 1: Vout1 Ch 2: Vout2

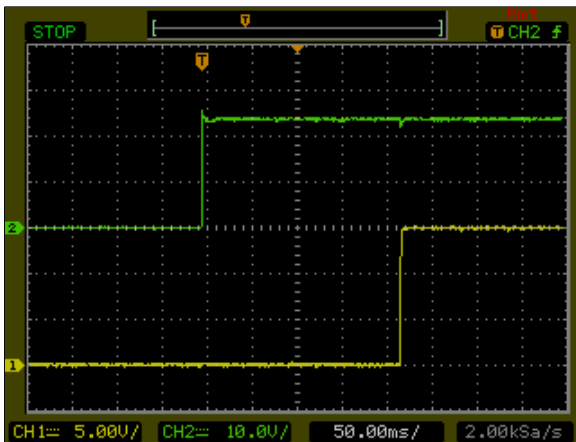

Figure 61: ASA01CC24-M Output Voltage Startup Characteristic by Vin  
 Vin = 24Vdc Load: Io = ± 0.2A  
 Ch 1: Vin Ch 2: Vo

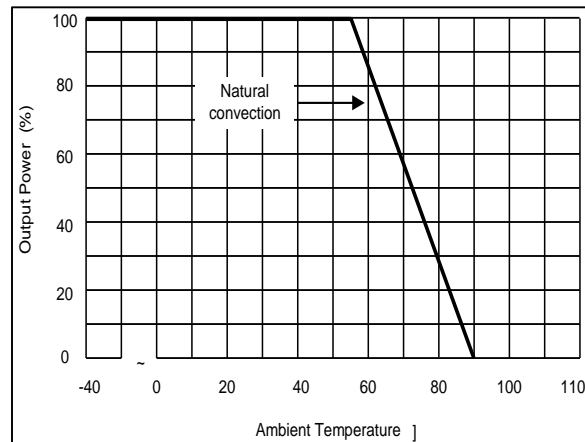

Figure 62: ASA01CC24-M Output Current Versus Ambient Temperature  
 Vin = 24Vdc Load: Io = ± 0.2A

## Electrical Specifications

### ASA01CC24-M Performance Curves

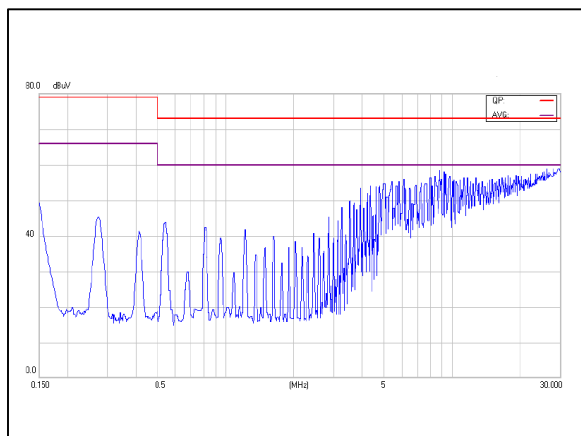

Figure 63: ASA01CC24-M Conduction Emission of EN55022 Class A  
 Vin = 24Vdc Load: Io = ± 0.2A

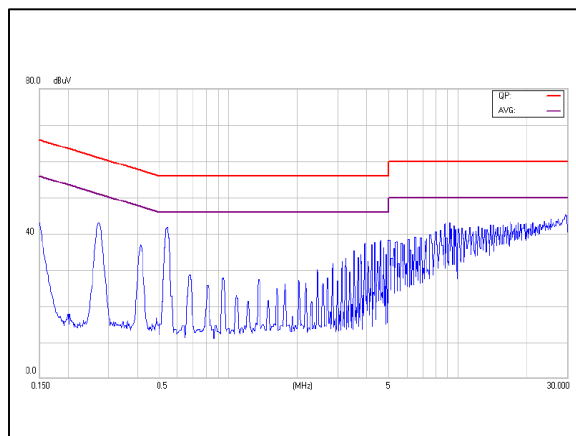

Figure 64: ASA01CC24-M Conduction Emission of EN55022 Class B  
 Vin = 24Vdc Load: Io = ± 0.2A

Note - All test conditions are at 25 °C

# Electrical Specifications

## ASA01A48-M Performance Curves

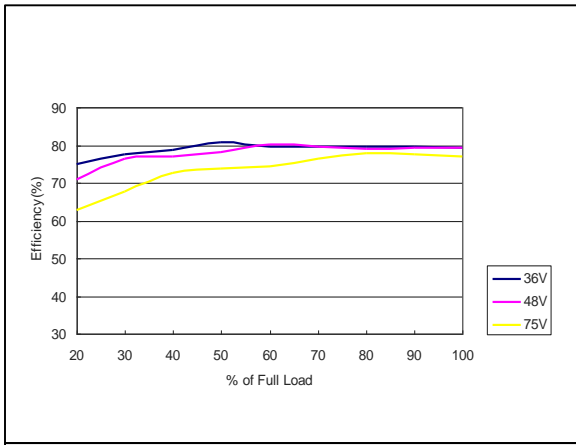

Figure 65: ASA01A48-M Efficiency Versus Output Current Curve  
 Vin = 36 to 75Vdc Load: Io = 0 to 1A

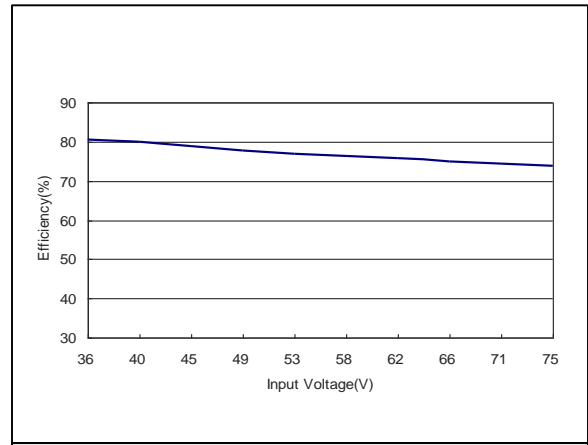

Figure 66: ASA01A48-M Efficiency Versus Input Voltage Curve  
 Vin = 36 to 75Vdc Load: Io = 1A

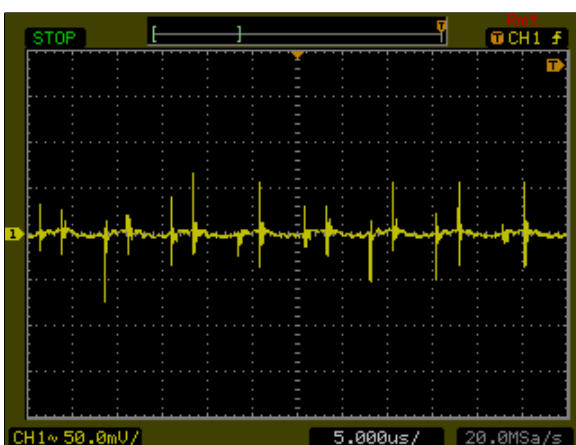

Figure 67: ASA01A48-M Ripple and Noise Measurement  
 Vin = 48Vdc Load: Io = 1A  
 Ch 1: Vo

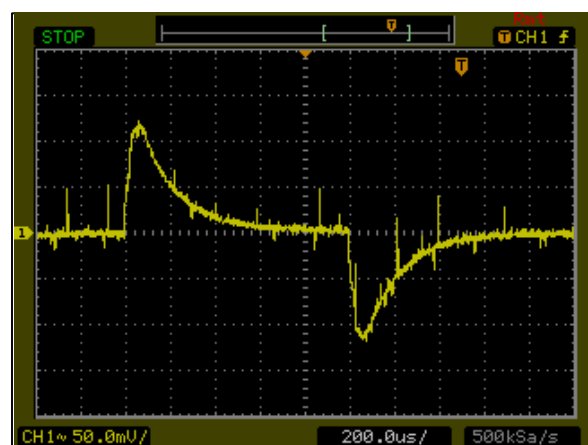

Figure 68: ASA01A48-M Transient Response  
 Vin = 48Vdc Load: Io = 100% to 75% load change  
 Ch 1: Vo

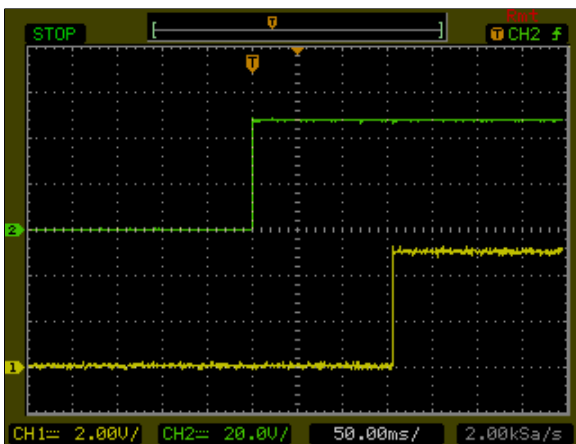

Figure 69: ASA01A48-M Output Voltage Startup Characteristic by Vin  
 Vin = 48Vdc Load: Io = 1A  
 Ch 1: Vin Ch 2: Vo

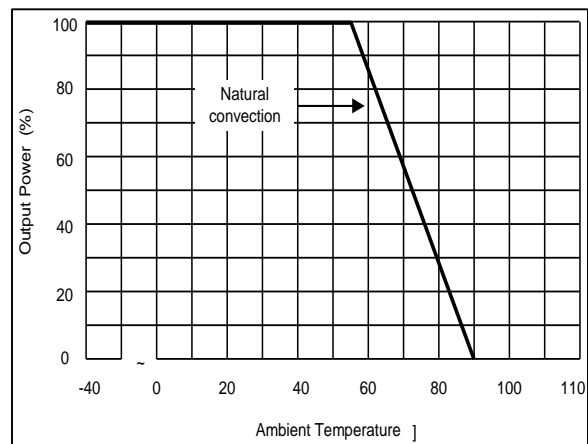

Figure 70: ASA01A48-M Output Current Versus Ambient Temperature  
 Vin = 48Vdc Load: Io = 1A



## Electrical Specifications

### ASA01A48-M Performance Curves

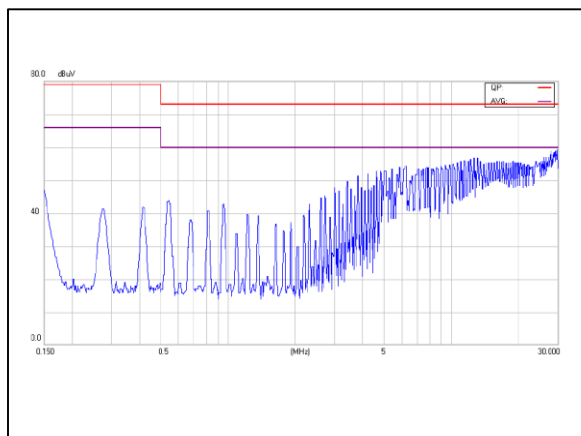

Figure 71: ASA01A48-M Conduction Emission of EN55022 Class A  
 Vin = 48Vdc Load: Io = 1A

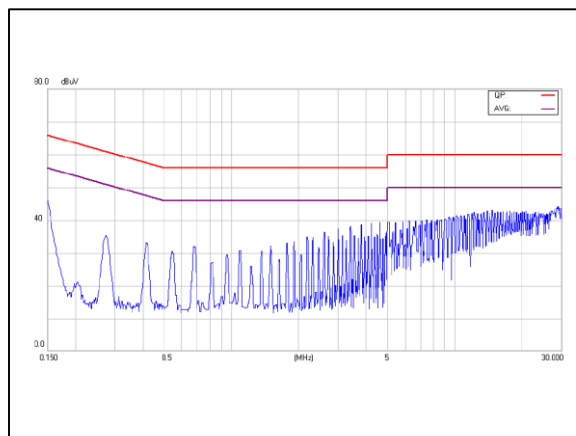

Figure 72: ASA01A48-M Conduction Emission of EN55022 Class B  
 Vin = 48Vdc Load: Io = 1A

Note - All test conditions are at 25 °C

# Electrical Specifications

## ASA01B48-M Performance Curves

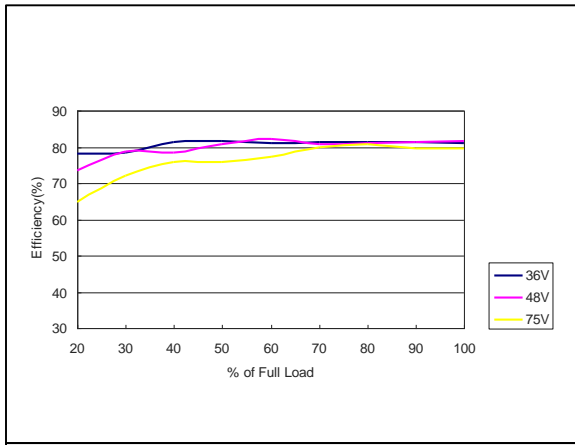

Figure 73: ASA01B48-M Efficiency Versus Output Current Curve  
 Vin = 36 to 75Vdc Load: Io = 0 to 0.5A

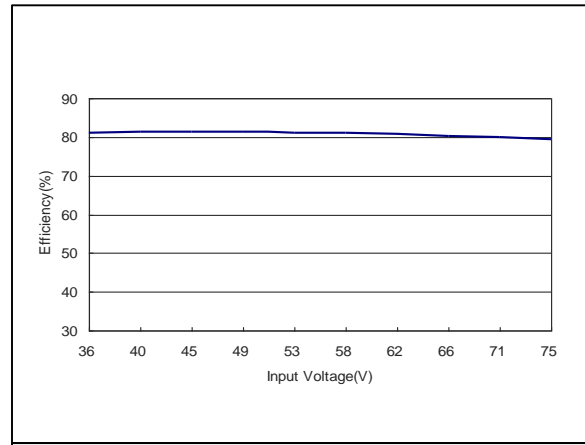

Figure 74: ASA01B48-M Efficiency Versus Input Voltage Curve  
 Vin = 36 to 75Vdc Load: Io = 0.5A

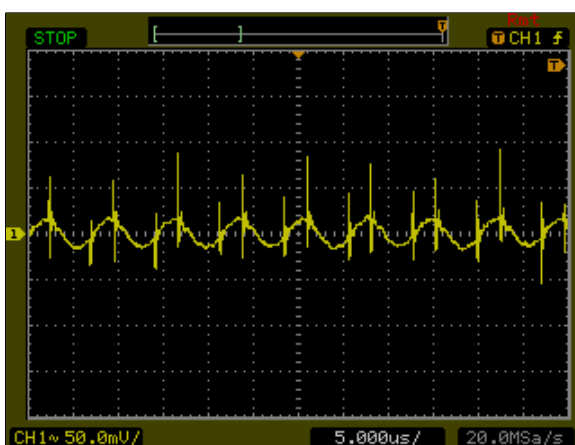

Figure 75: ASA01B48-M Ripple and Noise Measurement  
 Vin = 48Vdc Load: Io = 0.5A  
 Ch 1: Vo

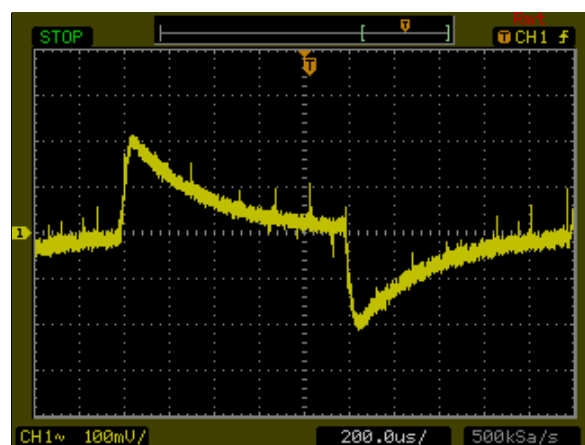

Figure 76: ASA01B48-M Transient Response  
 Vin = 48Vdc Load: Io = 100% to 75% load change  
 Ch 1: Vo

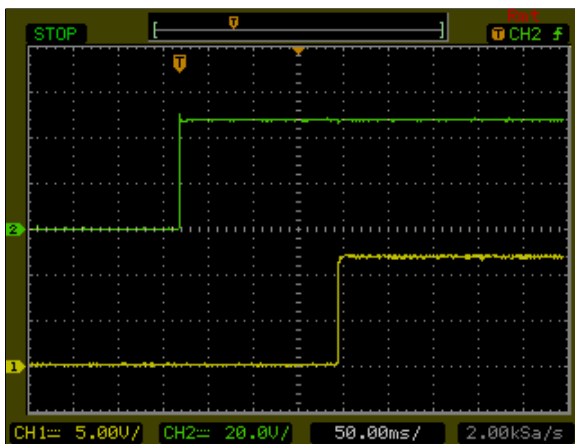

Figure 77: ASA01B48-M Output Voltage Startup Characteristic by Vin  
 Vin = 48Vdc Load: Io = 0.5A  
 Ch 1: Vin Ch 2: Vo

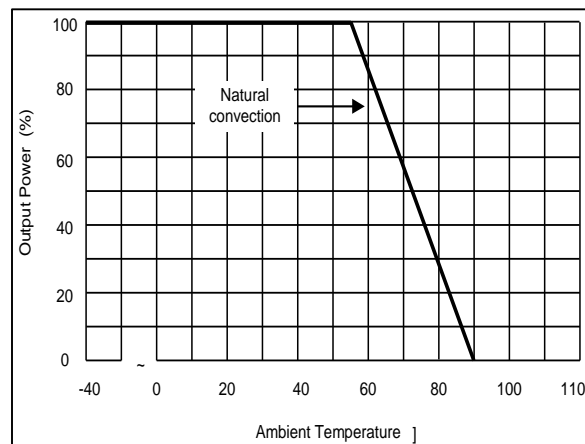

Figure 78: ASA01B48-M Output Current Versus Ambient Temperature  
 Vin = 48Vdc Load: Io = 0.5A

## Electrical Specifications

### ASA01B48-M Performance Curves

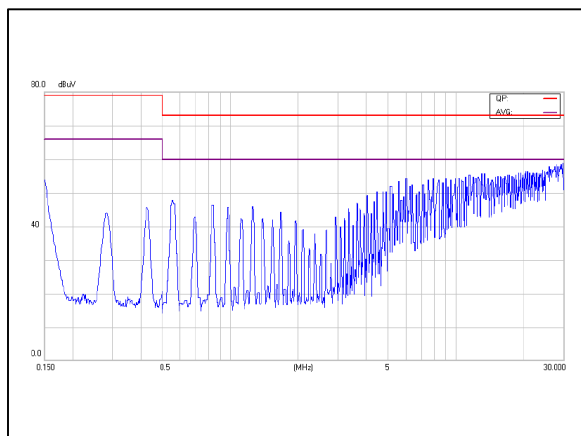

Figure 79: ASA01B48-M Conduction Emission of EN55022 Class A  
 Vin = 48Vdc Load: Io = 0.5A

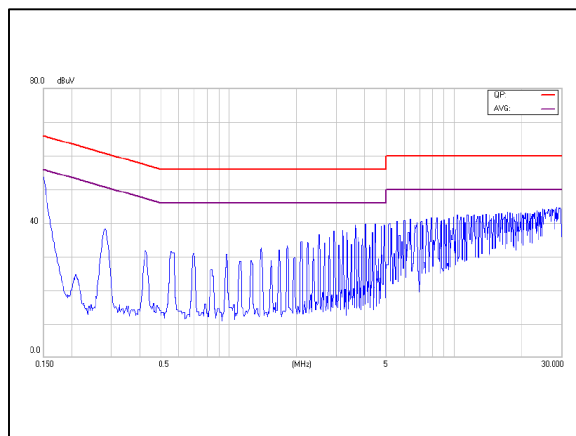

Figure 80: ASA01B48-M Conduction Emission of EN55022 Class B  
 Vin = 48Vdc Load: Io = 0.5A

Note - All test conditions are at 25 °C

# Electrical Specifications

## ASA01BB48-M Performance Curves

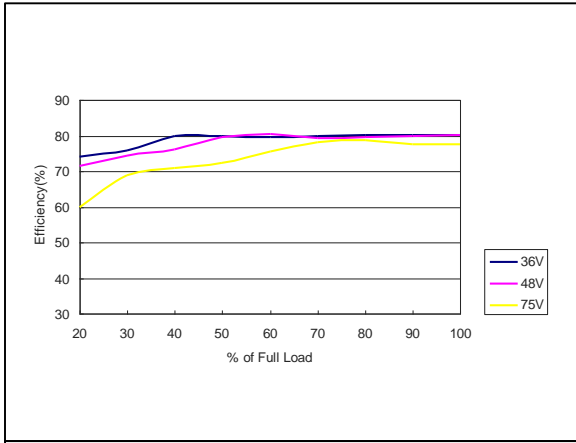

Figure 81: ASA01BB48-M Efficiency Versus Output Current Curve  
 Vin = 36 to 75Vdc Load: Io = 0 to ± 0.25A

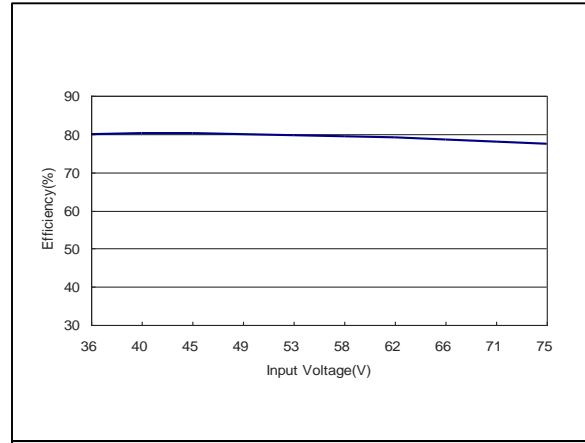

Figure 82: ASA01BB48-M Efficiency Versus Input Voltage Curve  
 Vin = 36 to 75Vdc Load: Io = ± 0.25A



Figure 83: ASA01BB48-M Ripple and Noise Measurement  
 Vin = 48Vdc Load: Io = ± 0.25A  
 Ch 1: Vout1 Ch 2: Vout2

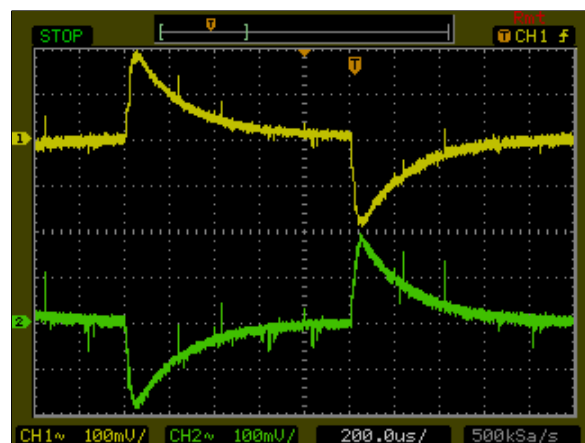

Figure 84: ASA01BB48-M Transient Response  
 Vin = 48Vdc Load: Io = 100% to 75% load change  
 Ch 1: Vout1 Ch 2: Vout2

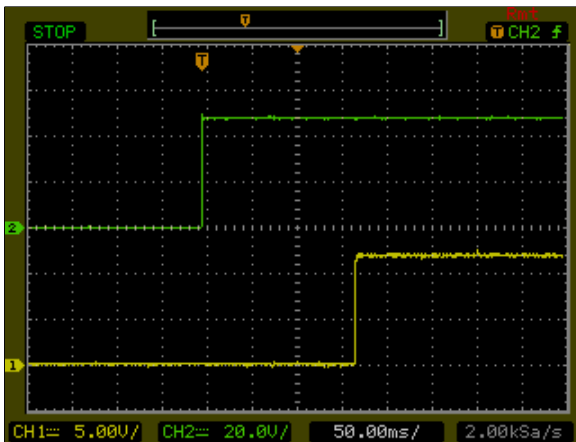

Figure 85: ASA01BB48-M Output Voltage Startup Characteristic by Vin  
 Vin = 48Vdc Load: Io = ± 0.25A  
 Ch 1: Vin Ch 2: Vo

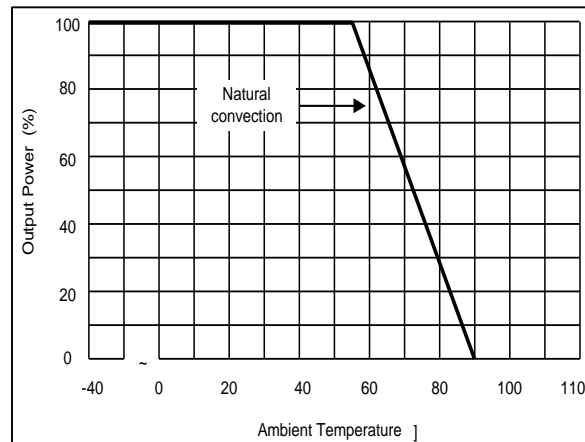

Figure 86: ASA01BB48-M Output Current Versus Ambient Temperature  
 Vin = 48Vdc Load: Io = ± 0.25A

# Electrical Specifications

## ASA01BB48-M Performance Curves

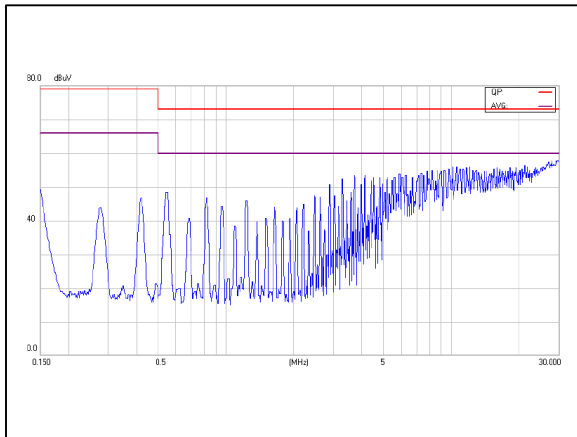

Figure 87: ASA01BB48-M Conduction Emission of EN55022 Class A  
 Vin = 48Vdc Load: Io = ± 0.25A

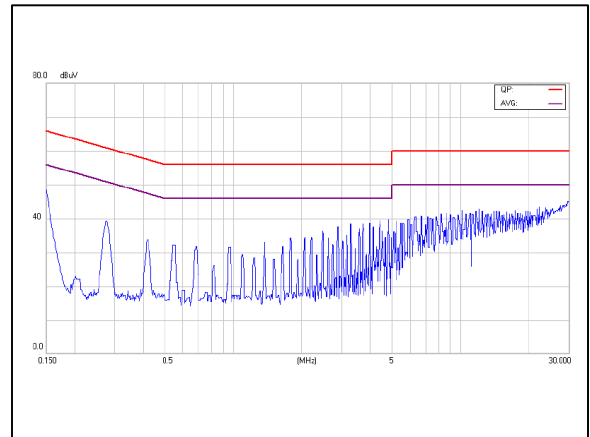

Figure 88: ASA01BB48-M Conduction Emission of EN55022 Class B  
 Vin = 48Vdc Load: Io = ± 0.25A

Note - All test conditions are at 25 °C

# Electrical Specifications

## ASA01CC48-M Performance Curves

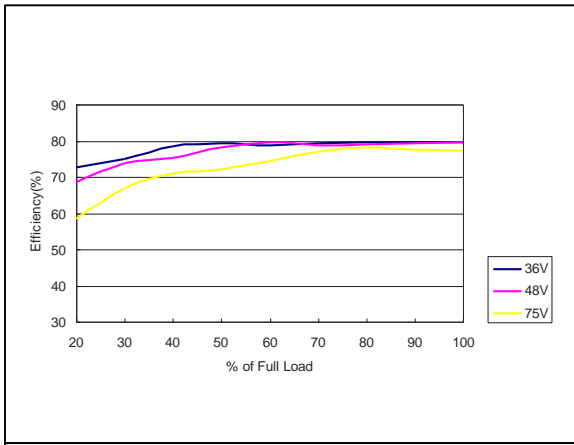

Figure 89: ASA01CC48-M Efficiency Versus Output Current Curve  
 Vin = 36 to 75Vdc Load: Io = 0 to ± 0.2A

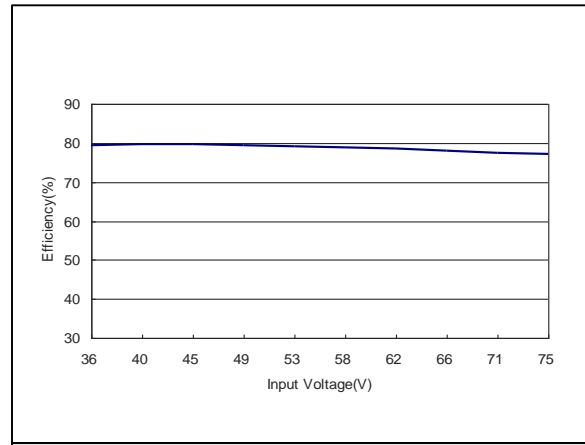

Figure 90: ASA01CC48-M Efficiency Versus Input Voltage Curve  
 Vin = 36 to 75Vdc Load: Io = ± 0.2A



Figure 91: ASA01CC48-M Ripple and Noise Measurement  
 Vin = 48Vdc Load: Io = ± 0.2A  
 Ch 1: Vout1 Ch 2: Vout2

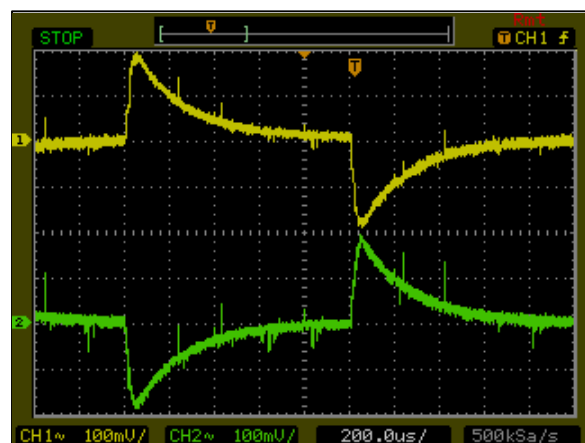

Figure 92: ASA01CC48-M Transient Response  
 Vin = 48Vdc Load: Io = 100% to 75% load change  
 Ch 1: Vout1 Ch 2: Vout2

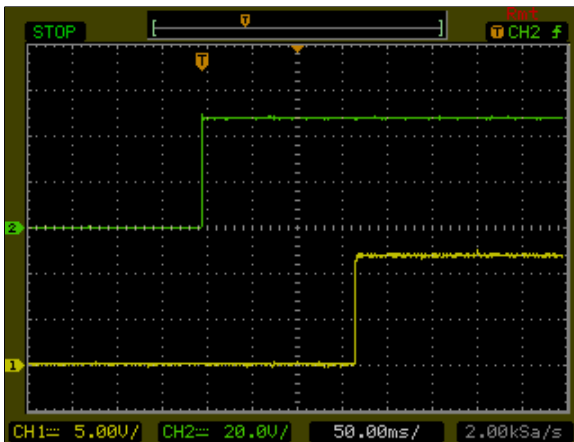

Figure 93: ASA01CC48-M Output Voltage Startup Characteristic by Vin  
 Vin = 48Vdc Load: Io = ± 0.2A  
 Ch 1: Vin Ch 2: Vo

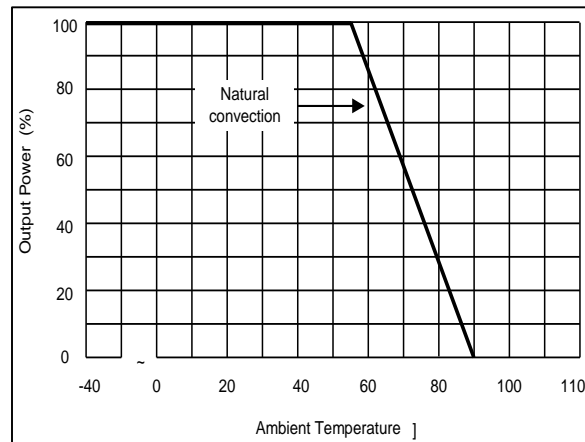

Figure 94: ASA01CC48-M Output Current Versus Ambient Temperature  
 Vin = 48Vdc Load: Io = ± 0.2A

## Electrical Specifications

### ASA01CC48-M Performance Curves

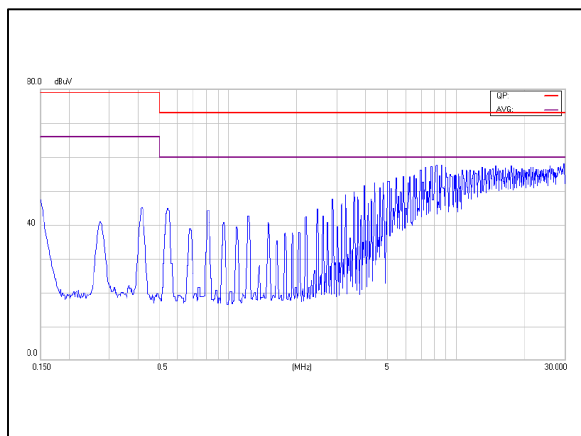

Figure 95: ASA01CC48-M Conduction Emission of EN55022 Class A  
 Vin = 48Vdc Load: Io = ± 0.2A

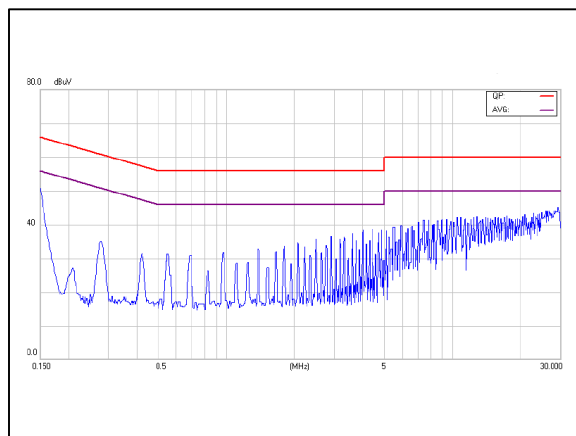
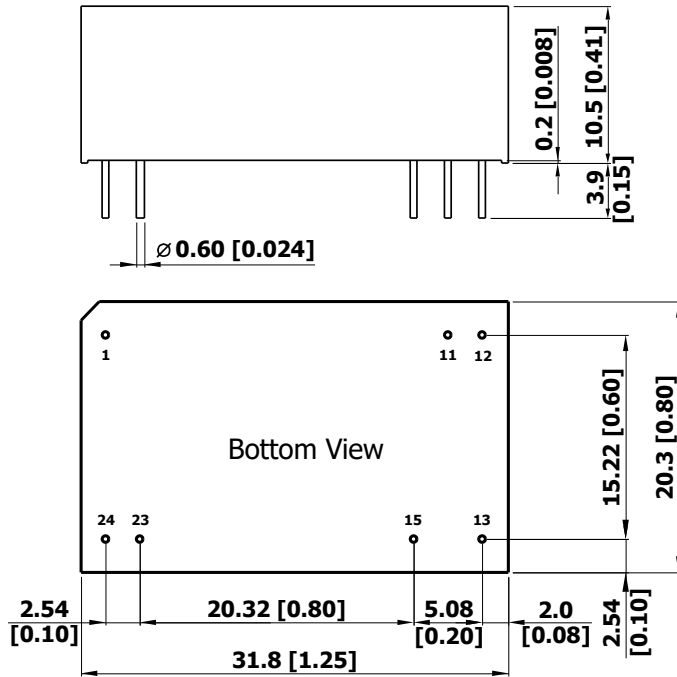

Figure 96: ASA01CC48-M Conduction Emission of EN55022 Class B  
 Vin = 48Vdc Load: Io = ± 0.2A

Note - All test conditions are at 25 °C

## Mechanical Specifications

### Mechanical Outlines (unit: mm)



Note:

1.All dimensions in mm (inches)

Tolerance: X.X±0.25 (X.XX±0.01)

X.XX±0.13 (X.XXX±0.005)

2.Pin pitch tolerance:±0.25 (±0.01)

3.Pin tolerance:±0.05 (±0.002)

### Pin Connections

#### Single output

Pin 1	-	+Vin
Pin 11	-	No Pin
Pin 12	-	-Vout
Pin 13	-	+Vout
Pin 15	-	No Pin
Pin 23	-	-Vin
Pin 24	-	-Vin

#### Dual Output

Pin 1	-	+Vin
Pin 11	-	Common
Pin 12	-	No Pin
Pin 13	-	-Vout
Pin 15	-	+Vout
Pin 23	-	-Vin
Pin 24	-	-Vin

### Physical Characteristics

Device code suffix	L
Case Size	31.8x20.3x12mm (1.25x0.8x0.47 inches)
Case Material	Non-Conductive Black Plastic (flammability to UL 94V-0 rated)
Weight	18g



## Mechanical Specifications

### Recommended Pad Layout for Single & Dual Output Converter

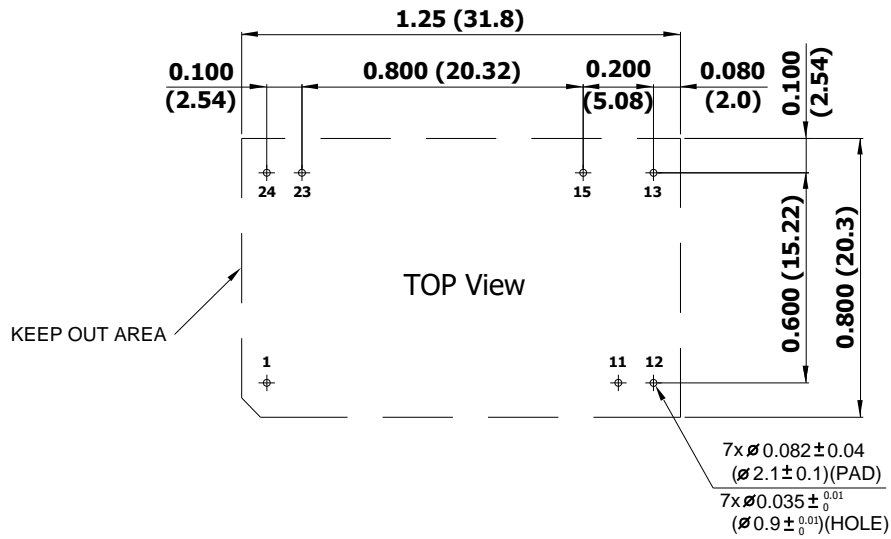

- All dimensions in Inches (mm)  
Tolerance:  $x.xx \pm 0.02$ " ( $x.x \pm 0.5$ mm)  
 $x.xxx \pm 0.01$ " ( $x.xx \pm 0.25$ mm)
- Pin pitch tolerance:  $\pm 0.01$ " ( $\pm 0.25$ mm)

## Mechanical Specifications

### Power Derating Curves

ASA6W Series can operate up to a maximum ambient temperature of 75°C with derating.

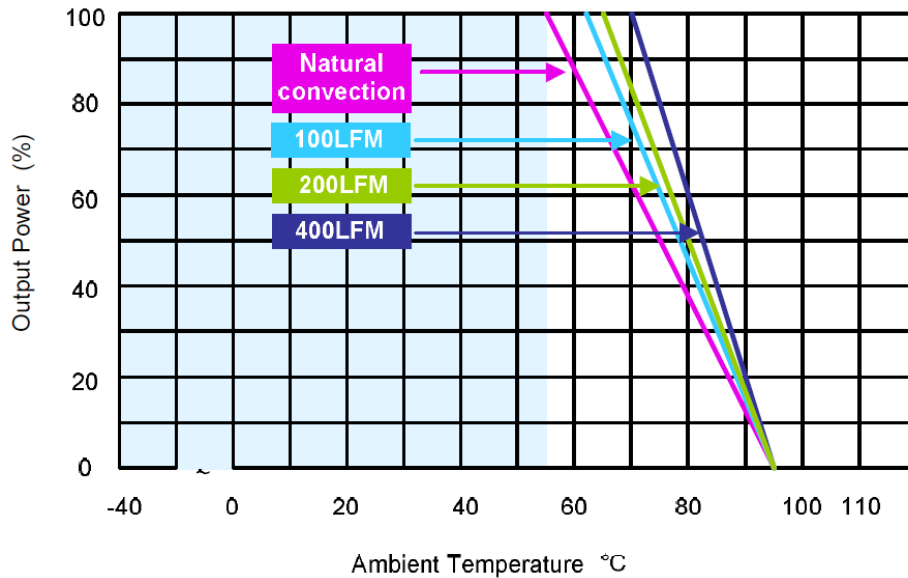

Notes:

1. Specifications typical at Ta=+25°C, resistive load, nominal input voltage and rated output current unless otherwise noted.
2. Transient recovery time is measured to within 1% error band for a step change in output load of 75% to 100%.
3. Ripple & Noise measurement bandwidth is 0-20 MHz.
4. These power converters require a minimum output loading to maintain specified regulation, operation under no-load conditions will not damage these modules; however, they may not meet all specifications listed.
5. All DC/DC converters should be externally fused at the front end for protection.
6. Other input and output voltage may be available, please contact factory.
7. Specifications subject to change without notice.

## Mechanical Specifications

### Weight

The ASA6W series weight is 18g maximum.

## Environmental Specifications

### EMC Considerations

EMI-Filter to meet EN 55022, class B, FCC part 15, class B

Conducted and radiated emissions EN55022 Class B

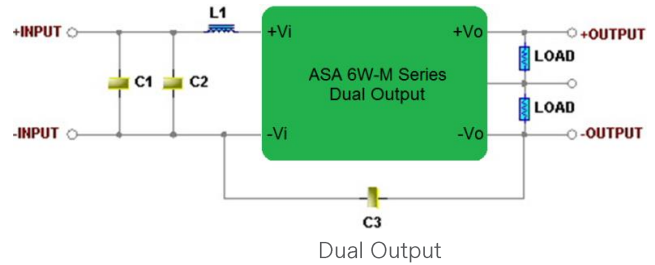
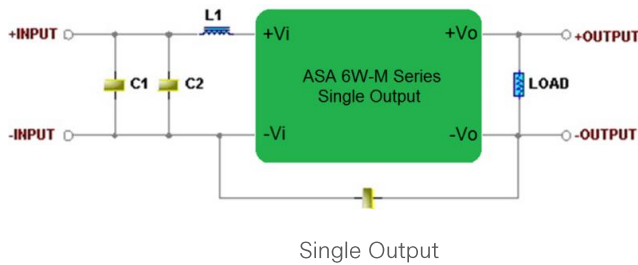

Recommended PCB Layout with Input Filter

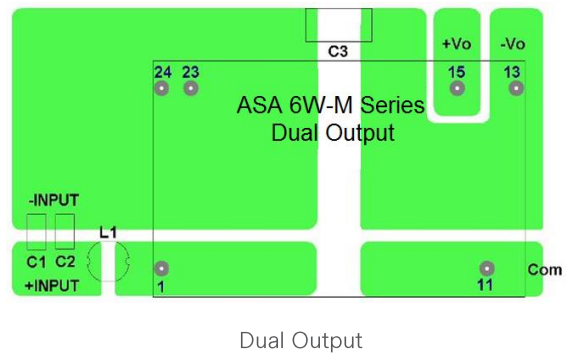
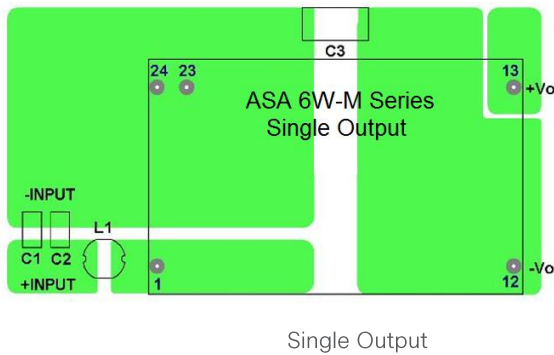

Table 4. Conducted EMI emission specifications

Model	Component	Value
ASAXXX12-M	C1	4.7μF/25V 1206 MLCC
	C3	100pF/6KV 2211 MLCC
	L1	1μH SCD03021T/2.08A
ASAXXX24-M	C1,C2	2.2μF/50V 1206 MLCC
	C3	100pF/6KV 2211 MLCC
	L1	1μH SCD03021T/2.08A
ASAXXX48-M	C1,C2	1μF/100V 1206 MLCC
	C3	100pF/6KV 2211 MLCC
	L1	1μH SCD03021T/2.08A

## Environmental Specifications

### Safety Certifications

The ASA 6W-M series power supply is intended for inclusion in other equipment and the installer must ensure that it is in compliance with all the requirements of the end application. This product is only for inclusion by professional installers within other equipment and must not be operated as a stand alone product.

Table 5. Safety Certifications for ASA 6W-M series power supply system	
Document	Description
cUL/UL 62368-1 (CSA certificate)	US and Canada Requirements
IEC/EN 62368-1 (CB-scheme)	European Requirements

## Environmental Specifications

### MTBF and Reliability

The MTBF of ASA6W series of DC/DC converters has been calculated using MIL-HDBK 217F NOTICE2, Operating Temperature 25 °C, Ground Benign.

Model	MTBF	Unit
ASA01A12-M	1,056,971	Hours
ASA001B12-M	1,065,303	
ASA01BB12-M	1,070,778	
ASA01CC12-M	1,077,122	
ASA01A24-M	1,045,697	
ASA01B24-M	1,040,583	
ASA01BB24-M	1,053,741	
ASA01CC24-M	1,058,985	
ASA01A48-M	1,033,699	
ASA01B48-M	1,056,189	
ASA01BB48-M	1,040,583	
ASA01CC48-M	1,051,746	

## Application Notes

### Input Reflected-Ripple Current Test Setup

Input reflected-ripple current is measured with an inductor  $L_{in}$  ( $4.7\mu\text{H}$ ) and  $C_{in}$  ( $220\mu\text{F}$ ,  $\text{ESR} < 1.0\Omega$  at  $100\text{ KHz}$ ) to simulate source impedance. Capacitor  $C_{in}$ , offsets possible battery impedance. Current ripple is measured at the input terminals of the module, measurement bandwidth is  $0\text{-}500\text{ KHz}$ .

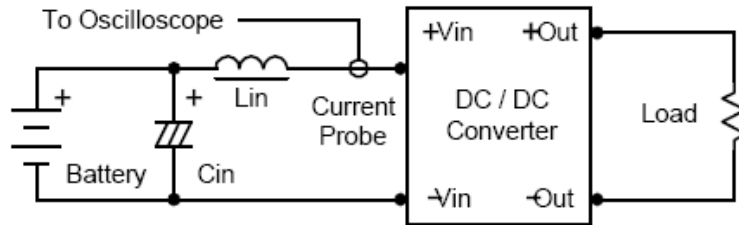

Component	Value	Reference
$L_{in}$	$4.7\mu\text{H}$	-
$C_{in}$	$220\mu\text{F}$ ( $\text{ESR} < 1.0\Omega$ at $100\text{ KHz}$ )	Aluminum Electrolytic Capacitor

## Application Notes

### Peak-to-Peak Output Noise Measurement Test

Use a 0.47uF ceramic capacitor. Scope measurement should be made by using a BNC socket, measurement bandwidth is 0-20MHz. Position the load between 50 mm and 75 mm from the DC/DC Converter.

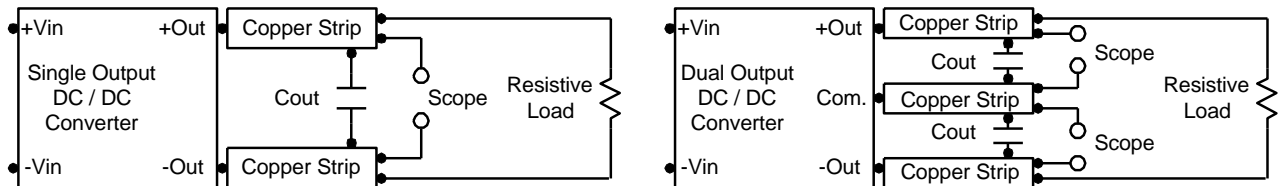

### Output voltage and efficiency measurement test set up

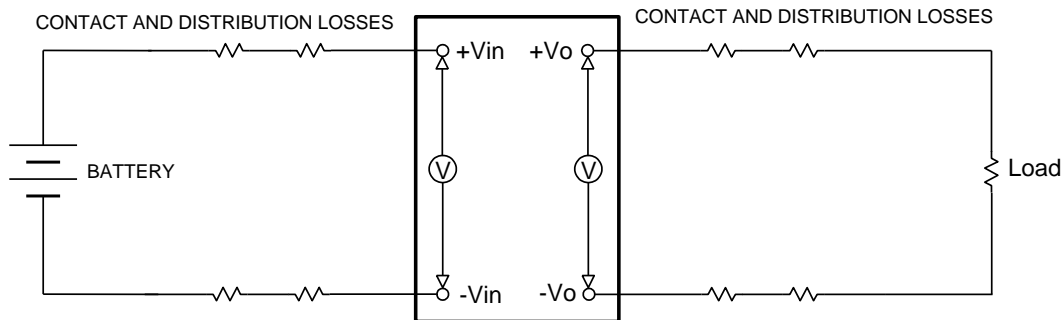

$$Efficiency = \left( \frac{V_{out} \times I_{out}}{V_{in} \times I_{in}} \right) \times 100\% = [\%]$$

### Short Circuitry Protection

Continuous, hiccup and auto-recovery mode.

During short circuit, converter still shut down, The average current during this condition will be very low and the device will be safe in this condition.



## Application Notes

### Input Source Impedance

The power module should be connected to a low ac-impedance input source. Highly inductive source impedances can affect the stability of the power module.

In applications where power is supplied over long lines and output loading is high, it may be necessary to use a capacitor at the input to ensure startup.

Capacitor mounted close to the power module helps ensure stability of the unit, it is recommended to use a good quality low Equivalent Series Resistance (ESR <math>< 1.0\Omega</math> at 100 KHz) capacitor of a 10 $\mu$ F for the 12V input devices and a 4.7 $\mu$ F for the 24V input devices and a 2.2 $\mu$ F for the 48V devices.

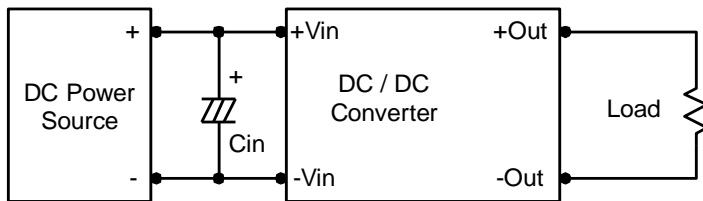

## Application Notes

### Thermal Considerations

Many conditions affect the thermal performance of the power module, such as orientation, airflow over the module and board spacing. To avoid exceeding the maximum temperature rating of the components inside the power module, the case temperature must be kept below 95°C. The derating curves are determined from measurements obtained in a test setup

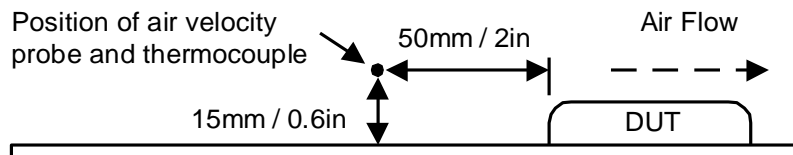

### Maximum Capacitive Load

The ASA6W series has limitation of maximum connected capacitance at the output. The power module may be operated in current limiting mode during start-up, affecting the ramp-up and the startup time. Connect capacitors at the point of load for best performance. The maximum capacitance can be found in the data sheet.

## Application Notes

### Packaging Information

#### TUBE

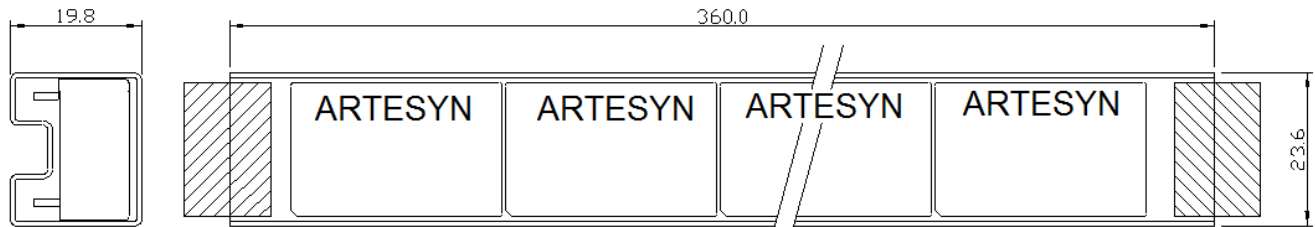

unit : mm

10 PCS per TUBE

### Soldering and Reflow Considerations

Lead free wave solder profile for ASA6W Series

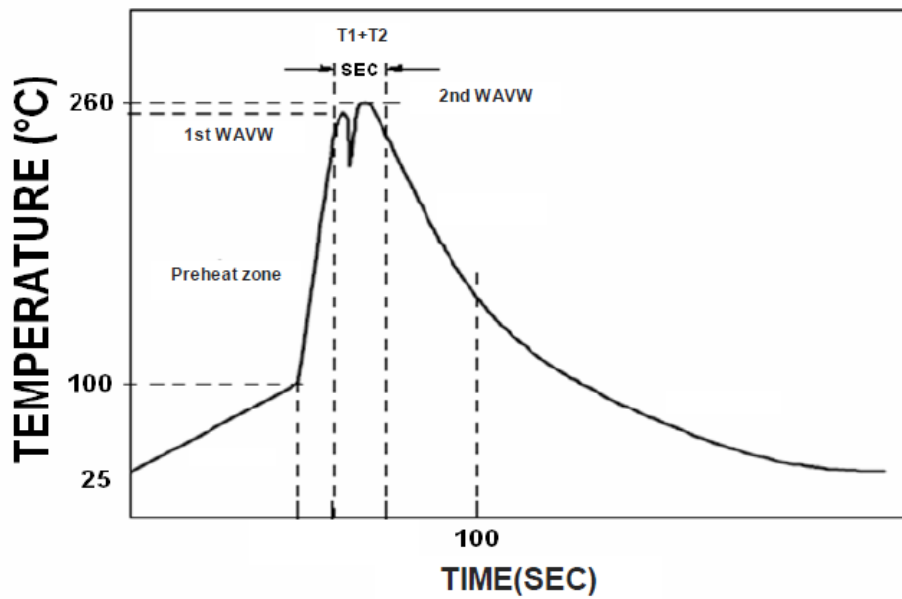

## Record of Revision and Changes

Issue	Date	Description	Originators
1.0	07.11.2016	First Issue	S. Dong
1.1	10.29.2020	Update 60950 to 62368	J. Ma



For international contact information,  
visit [advancedenergy.com](http://advancedenergy.com).

[powersales@aei.com](mailto:powersales@aei.com) (Sales Support)  
[productsupport.ep@aei.com](mailto:productsupport.ep@aei.com) (Technical Support)  
+1 888 412 7832

## ABOUT ADVANCED ENERGY

Advanced Energy (AE) has devoted more than three decades to perfecting power for its global customers. AE designs and manufactures highly engineered, precision power conversion, measurement and control solutions for mission-critical applications and processes.

Our products enable customer innovation in complex applications for a wide range of industries including semiconductor equipment, industrial, manufacturing, telecommunications, data center computing, and medical. With deep applications know-how and responsive service and support across the globe, we build collaborative partnerships to meet rapid technological developments, propel growth for our customers, and innovate the future of power.

## PRECISION | POWER | PERFORMANCE

---

Specifications are subject to change without notice. Not responsible for errors or omissions. ©2020 Advanced Energy Industries, Inc. All rights reserved. Advanced Energy®, and AE® are U.S. trademarks of Advanced Energy Industries, Inc.

Rev.10.29.20\_#1.1