

ARTESYN

AVD85B-48S05 Series

85 Watts Sixteenth-brick Converter



PRODUCT DESCRIPTION

Advanced Energy's Artesyn AVD85B-48S05 is a single output DC/DC converter with standard sixteenth-brick outline and pin configuration. It delivers up to 17A output current with 5V output. Above 91.5% ultra-high efficiency and excellent thermal performance makes it an ideal choice to supply power in telecom and datacom.

SPECIAL FEATURES

- Delivering up to 17A output current
- Ultra-high efficiency 91.5% typical at 17A load
- Wide input range: 36V to 75V
- Excellent thermal performance
- No minimum load requirement
- Basic isolation
- High power density
- Low output noise
- Startup Pre-bias
- RoHS 3.0
- Remote control function
- Remote output sense
- Trim function: 80% ~ 110%
- Input under voltage lockout
- Output over current protection
- Output short circuit protection
- Output over voltage protection
- Over temperature protection
- Industry standard sixteenth-brick pin-out outline

SAFETY

- UL UL/CSA 60950-1
- TUV EN 62368-1
- CE EN 62368-1

TYPICAL APPLICATIONS

- Telecom
- Datacom

AT A GLANCE

Total Power

85 Watts

Input Voltage

36 to 75 Vdc

of Outputs

Single



MODEL NUMBERS

Standard	Output Voltage	Structure	Remote ON/OFF logic	ROHS
AVD85B-48S05B-6L	5Vdc	Baseplate	Negative	RoHS 3.0
AVD85B-48S05-6L	5Vdc	Open Frame	Negative	RoHS 3.0
AVD85B-48S05TL	5Vdc	Open Frame	Negative	RoHS 3.0

Order Information

AVD85B	-	48	S	05	P	B	-	6	L
①		②	③	④	⑤	⑥	⑦	⑧	⑨

①	Model series	AVD: high efficiency sixteenth brick series, 85: output power 85W
②	Input voltage	48: 36V ~ 75V input range, rated input voltage 48V
③	Output number	S: single output
④	Rated output voltage	05: 5V output
⑤	Remote ON/OFF logic	Default: negative logic; P: positive logic
⑥	Baseplate	B: with baseplate; default: open frame
⑦	-	Need "-" for through-hole unit, to separate the data of voltage and pin length, omit for SMT unit
⑧	Pin length	T: SMT; 6: 3.8mm ± 0.25mm
⑨	RoHS status	L: RoHS 3.0

Options

None

ELECTRICAL SPECIFICATIONS

Absolute Maximum Ratings

Stress in excess of those listed in the “Absolute Maximum Ratings” may cause permanent damage to the power supply. These are stress ratings only and functional operation of the unit is not implied at these or any other conditions above those given in the operational sections of this TRN. Exposure to any absolute maximum rated condition for extended periods may adversely affect the power supply’s reliability.

Table 1. Absolute Maximum Ratings						
Parameter	Model	Symbol	Min	Typ	Max	Unit
Input Voltage Operating -Continuous Non-operating -100mS	All	$V_{IN,DC}$	-	-	80	Vdc
	All		-	-	100	Vdc
Maximum Output Power	All	$P_{O,max}$	-	-	85	W
Isolation Voltage ¹ Input to output	All		-	-	1500	Vdc
Ambient Operating Temperature	All	T_A	-40	-	+85	°C
Storage Temperature	All	T_{STG}	-55	-	+125	°C
Voltage at remote ON/OFF pin	All		-0.3	-	12	Vdc

Note 1 - 1mA for 60s, slew rate of 1500V/10s

ELECTRICAL SPECIFICATIONS

Input Specifications

Table 2. Input Specifications						
Parameter	Conditions ¹	Symbol	Min	Typ	Max	Unit
Operating Input Voltage, DC	All	$V_{IN,DC}$	36	48	75	Vdc
Turn-on Voltage Threshold	$I_O = I_{O,max}$	$V_{IN,ON}$	31	-	36	Vdc
Turn-off Voltage Threshold	$I_O = I_{O,max}$	$V_{IN,OFF}$	30	-	35	Vdc
Lockout Voltage Hysteresis	$I_O = I_{O,max}$		1	-	3	V
Maximum Input Current	$V_{IN,DC} = 36Vdc$ $I_O = I_{O,max}$	$I_{IN,max}$	-	-	3.5	A
Recommended Input Fuse	Fast blow external fuse recommended		-	-	5	A
Recommended External Input Capacitance	Low ESR capacitor recommended	C_{IN}	100	220	-	uF
Input Reflected Ripple Current	Through 12uH inductor		-	25	-	mA
Operating Efficiency	$I_O = I_{O,max}$	η	-	91.5	-	%
	$I_O = 50\% I_{O,max}$	η	-	91.0	-	%

Note 1 - $T_a = 25\text{ }^\circ\text{C}$, airflow rate = 400 LFM, $V_{in} = 48Vdc$, nominal V_{out} unless otherwise noted.

ELECTRICAL SPECIFICATIONS

Output Specifications

Table 3. Output Specifications							
Parameter	Conditions ¹	Symbol	Min	Typ	Max	Unit	
Factory Set Voltage	$V_{IN,DC} = 48Vdc$ $I_O = 50\% I_{O,max}$	V_O	4.95	5.0	5.05	Vdc	
Output Voltage Line Regulation	All	$\pm\%V_O$ $\pm V_O$	- -	- -	0.15 7.5	% mV	
Output Voltage Load Regulation	All	$\pm\%V_O$ $\pm V_O$	- -	- -	0.15 7.5	% mV	
Output Voltage Temperature Regulation	All	$\%V_O$	-	-	0.02	%/°C	
Total output voltage range (Over sample, line, load, temperature & life)	All	V_O	4.9	5.0	5.1	V	
Output Voltage Trim Range	All	V_O	4	-	5.3	V	
Output Ripple, pk-pk ²	20MHz bandwidth	V_O	-	50	-	mV _{PK-PK}	
Output Current	All	I_O	0	-	17	A	
Output DC current-limit inception ³		I_O	18.5	-	26	A	
V_O Load Capacitance ⁴	All	C_O	220	-	10000	µF	
V_O Dynamic Response	Peak Deviation Settling Time	25%~50%~25% or 50%~75%~50% 25% load change slew rate = 0.1A/us	$\pm V_O$ T_s	- -	90 50	- -	mV µSec
		25%~50%~25% or 50%~75%~50% 25% load change slew rate = 1A/us	$\pm V_O$ T_s	- -	120 100	- -	mV µSec
Turn-on transient	Rise time	T_{rise}	-	20	-	mS	
	Turn-on delay time	$T_{turn-on}$	-	10	-	mS	
	Output voltage overshoot	$\%V_O$	-	-	5	%	
Switching Frequency	All	f_{sw}	-	350	-	KHz	
Remote ON/OFF control (Positive logic)	Off-state voltage	All	-0.3	-	1.2	V	
	On-state voltage	All	3.5	-	5	V	
Remote ON/OFF control (Negative logic)	Off-state voltage	All	3.5	-	5	V	
	On-state voltage	All	-0.3	-	1.2	V	

Note 1 - $T_a = 25\text{ }^\circ\text{C}$, airflow rate = 400 LFM, $V_{in} = 48Vdc$, nominal V_{out} unless otherwise noted.

Note 2 - Test condition: 10µ tantalum($ESR \leq 100\text{ m}\Omega$)// 1µ ceramic capacitor; Figure 17.

Note 3 - Hiccup.

Note 4 - High frequency and low ESR is recommended.

ELECTRICAL SPECIFICATIONS

Output Specifications

Table 3. Output Specifications Con't						
Parameter	Conditions	Symbol	Min	Typ	Max	Unit
Output over-voltage protection ⁵	Static Dynamic	V _o	5.8 5.8	- -	6.7 7.0	V
Output over-temperature protection ⁶	All	T	-	120	-	°C
Over-temperature hysteresis	All	T	-	10	-	°C
+ Sense	All	%V _o	-	-	5	%
- Sense	All	%V _o	-	-	5	%
MTBF	Telcordia SR-332-2006; 80% load, 300LFM, 40 °C T _A		-	2.0	-	10 ⁶ h

Note 5 - Hiccup: auto-restart when over-voltage condition is removed.

Note 6 - Auto recovery.

ELECTRICAL SPECIFICATIONS

AVD85B-48S05 Performance Curves

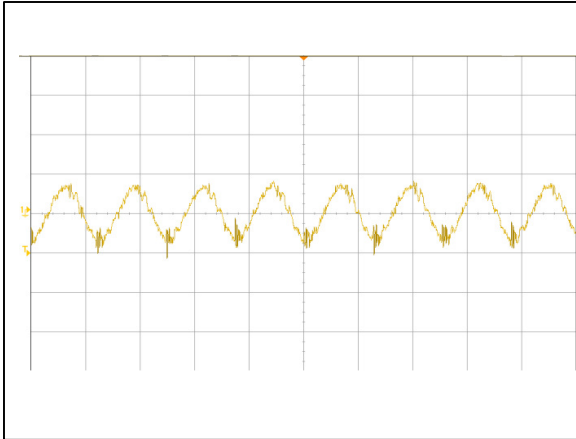

Figure 1: AVD85B-48S05 Input Reflected Ripple Current Waveform
Ch 1: lin (2uS/div, 10mA/div)

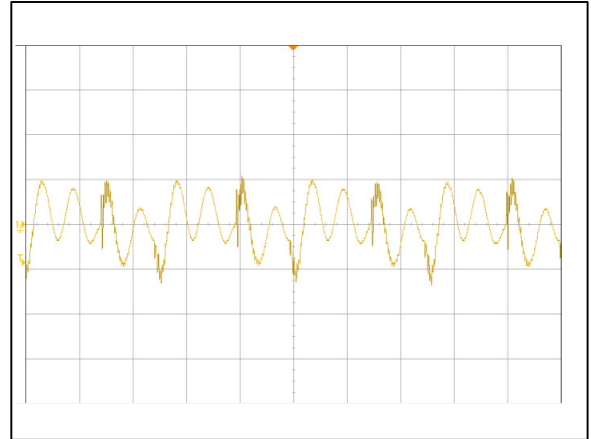

Figure 2: AVD85B-48S05 Ripple and Noise Measurement
Ch 1: Vo (1uS/div, 20mV/div)

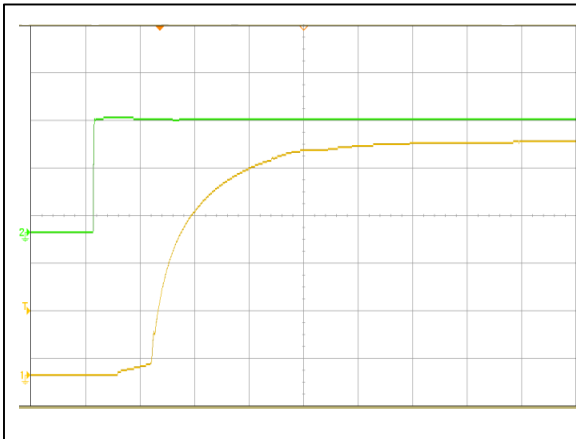

Figure 3: AVD85B-48S05 Output Voltage Startup Characteristic (10mS/div)
Ch 1: Vo (1V/div) Ch 2: Vin (20V/div)

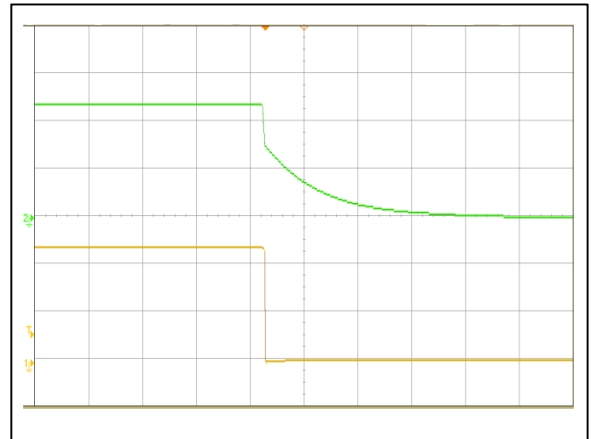

Figure 4: AVD85B-48S05 Turn Off Characteristic (20mS/div)
Ch 1: Vo (2V/div) Ch 2: Vin (20V/div)

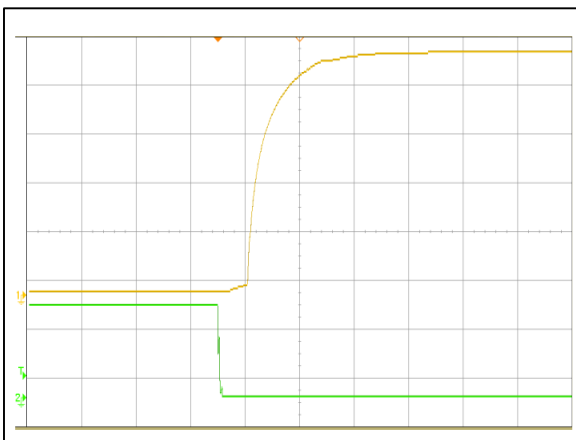

Figure 5: AVD85B-48S05 Remote ON Waveform (20mS/div)
Ch 1: Vo (1V/div) Ch 2: Remote ON (2V/div)

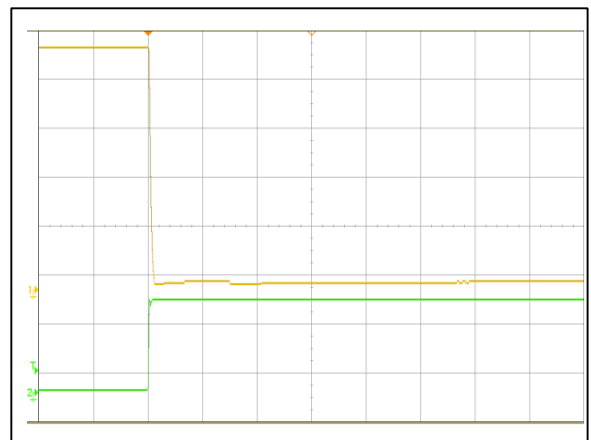

Figure 6: AVD85B-48S05 Remote OFF Waveform (10mS/div)
Ch 1: Vo (1V/div) Ch 2: Remote ON (2V/div)

ELECTRICAL SPECIFICATIONS

AVD85B-48S05 Performance Curves

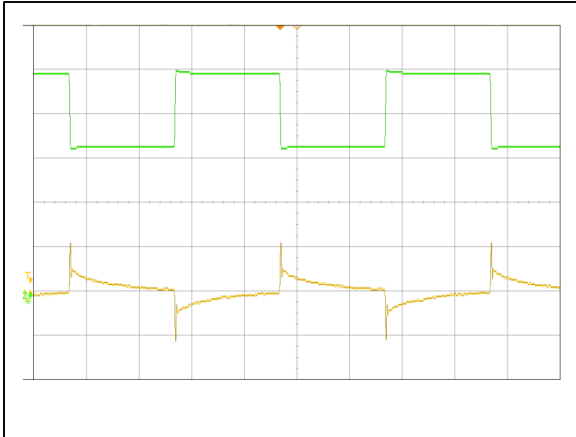

Figure 7: AVD85B-48S05 Transient Response (2mS/div)
50%~75%~50% load change, 0.1A/uS slew rate,
Ch 1: Vo (50mV/div) Ch 2: Io (2.5A/div)

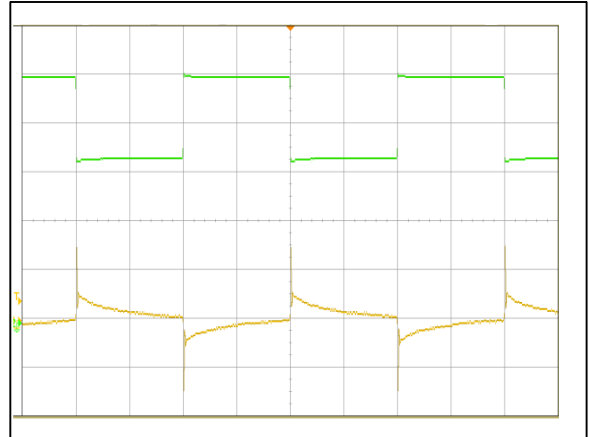

Figure 8: AVD85B-48S05 Transient Response (2mS/div)
50%~75%~50% load change, 1A/uS slew rate,
Ch 1: Vo (50mV/div) Ch 2: Io (2.5A/div)

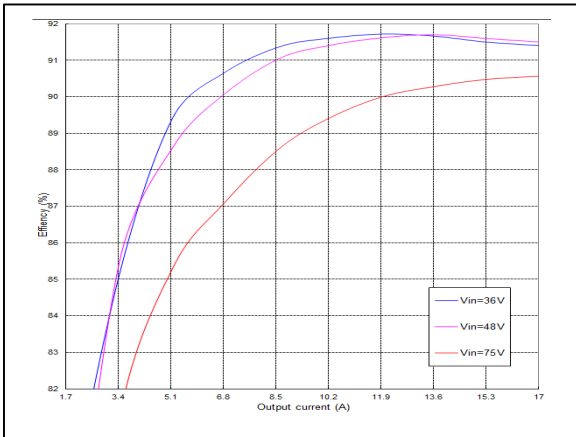

Figure 9: AVD85B-48S05 Efficiency Curves @ 25 °C, 400LFM
Loading: Io = 10% increment to 17A

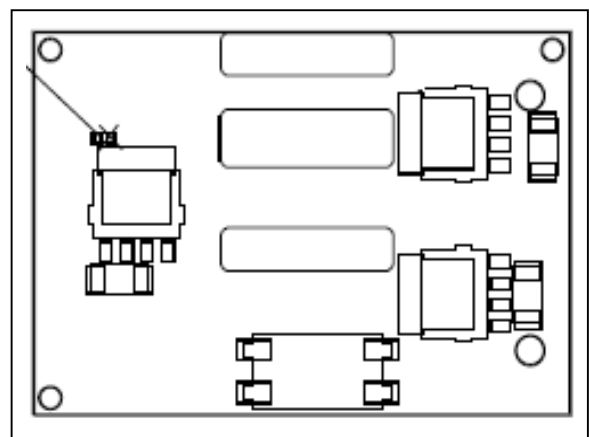

Figure 10: AVD50B-48S3V3 OTP test point (Open-frame module)

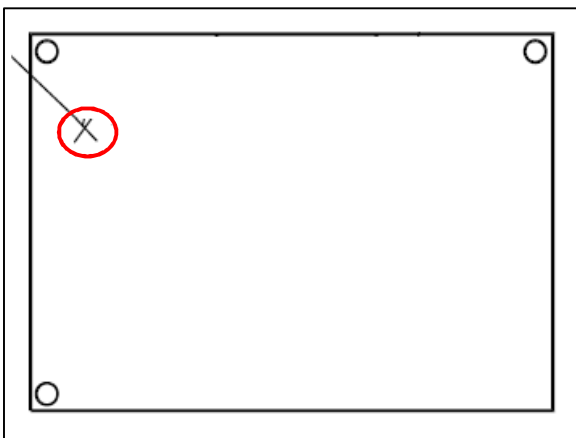
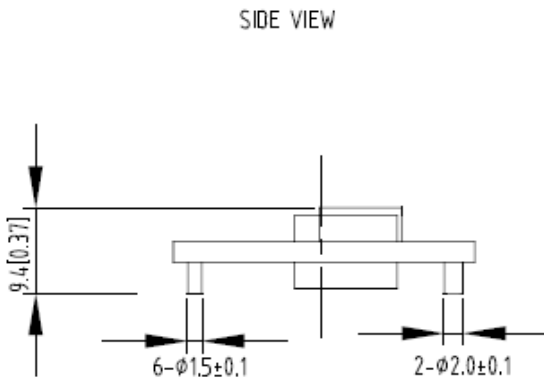
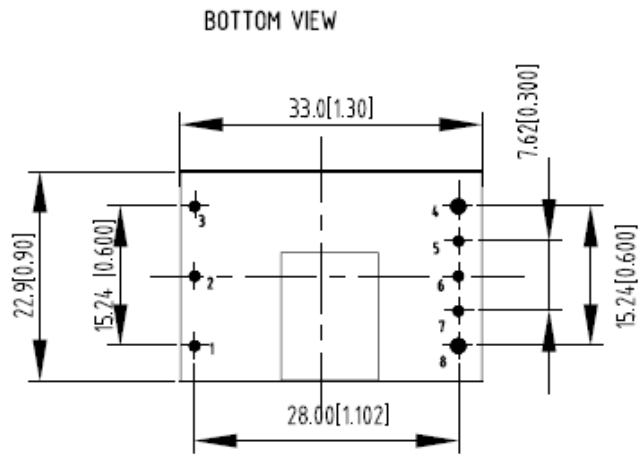

Figure 11: AVD50B-48S3V3B OTP test point (Module with baseplate)

MECHANICAL SPECIFICATIONS

Mechanical Outlines – Open-Frame Module with SMT Pin

AVD85B-48S05TL



UNIT: mm[inch]

TOLERANCE: X.Xmm±0.5mm[X.XX in.±0.02in.]
 X.XXmm±0.25mm[X.XXX in.±0.01in.]

MECHANICAL SPECIFICATIONS

Mechanical Outlines – Open Frame Module

AVD85B-48S05-6L

BOTTOM VIEW

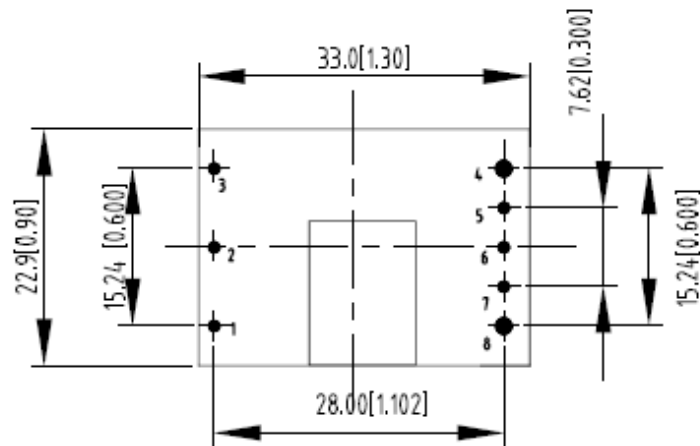

SIDE VIEW

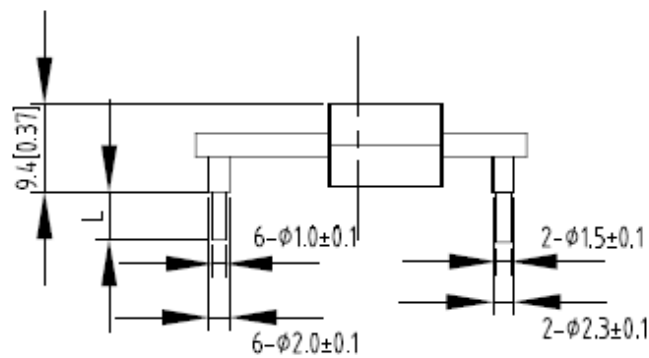

UNIT: mm[inch]

TOLERANCE: X.Xmm±0.5mm[X.XX in.±0.02in.]

X.XXmm±0.25mm[X.XXX in.±0.01in.]

MECHANICAL SPECIFICATIONS

Mechanical Outlines – Base plate Module

AVD85B-48S05B-6L

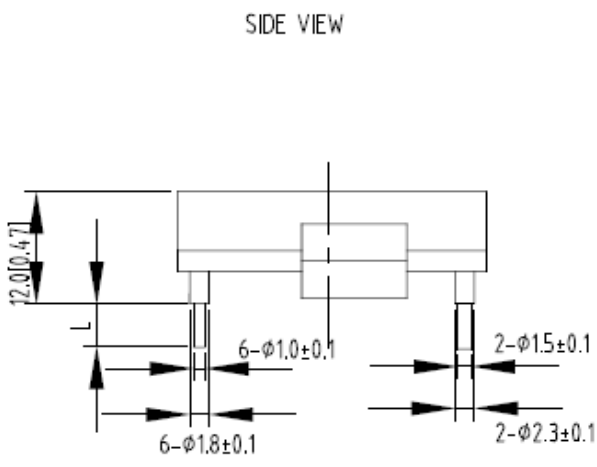
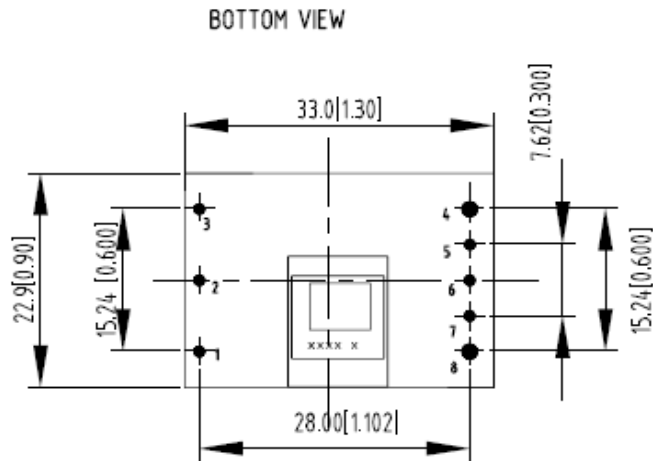

UNIT: mm[inch]

TOLERANCE: X.Xmm±0.5mm[X.XX in.±0.02in.]
 X.XXmm±0.25mm[X.XXX in.±0.01in.]

Note: Depth penetration into base plate, of M3 screws used at baseplate mounting holes, not to exceed maximum of 3.0mm

MECHANICAL SPECIFICATIONS

Pin length option

Device code suffix	L
-4	4.8mm ± 0.2mm
-6	3.8mm ± 0.2mm
-8	2.8mm ± 0.2mm
None	5.8mm ± 0.2mm

Pin Designations

Pin No	Name	Function
1	Vin+	Positive input voltage
2	Remote On/Off	Remote control
3	Vin-	Negative input voltage
4	Vo-	Negative output voltage
5	Sense-	Negative remote sense
6	Trim	Output voltage trim
7	Sense+	Positive remote sense
8	Vo+	Positive output voltage

ENVIRONMENTAL SPECIFICATIONS

EMC Immunity

AVD85B-48S05 power supply is designed to meet the following EMC immunity specifications:

Table 4. Environmental Specifications		
Document	Description	Criteria
EN55032, DC input port, Class A	Conducted and Radiated EMI Limits	/
IEC/EN 61000-4-2, Enclosure port, Level 3	Electromagnetic Compatibility (EMC) - Testing and measurement techniques: Electrostatic discharge immunity test	B
IEC/EN 61000-4-4, Level 3	Electromagnetic Compatibility (EMC) - Testing and measurement techniques: Electrical Fast Transient. DC input port	B
IEC/EN 61000-4-5	Electromagnetic Compatibility (EMC) - Testing and measurement techniques: Immunity to surges - 600V common mode and 600V differential mode for DC input port	B
IEC/EN 61000-4-6, Level 2	Electromagnetic Compatibility (EMC) - Testing and measurement techniques: Continuous Conducted Interference. DC input port	A
EN61000-4-29	Electromagnetic Compatibility (EMC) - Testing and measurement techniques: Voltage Dips and short interruptions and voltage variations. DC input port	B

Criterion A: Normal performance during and after test.

Criterion: For EFT and surges, low-voltage protection or reset is not allowed. Temporary output voltage fluctuation ceases after disturbances ceases, and from which the EUT recovers its normal performance automatically.

For Dips and ESD, output voltage fluctuation or reset is allowed during the test, but recovers to its normal performance automatically after the disturbance ceases.

Criterion C: Temporary loss of output, the correction of which requires operator intervention.

Criterion D: Loss of output which is not recoverable, owing to damage to hardware.

ENVIRONMENTAL SPECIFICATIONS

Safety Certifications

The AVD85B-48S05 power supply is intended for inclusion in other equipment and the installer must ensure that it is in compliance with all the requirements of the end application. This product is only for inclusion by professional installers within other equipment and must not be operated as a stand alone product.

Table 5. Safety Certifications for AVD85B-48S05 power supply system		
Standard	Agency	Description
UL 60950-1, 2nd Edition, 2014-10-14; CAN/CSA C22.2 No. 60950-1-07, 2nd Edition, 2014-10	UL+CUL	US and Canada Requirements
EN 62368-1:2014/A11:2017	TUV-SUD	European Requirements
EN 62368-1:2014/A11:2017	CE	CE Marking

ENVIRONMENTAL SPECIFICATIONS

Operating Temperature

The AVD120 series power supplies will start and operate within stated specifications at an ambient temperature from -40 °C to 85 °C under all load conditions. The storage temperature is -55 °C to 125 °C

Thermal Considerations – Open-Frame module

The converter is designed to operate in different thermal environments and sufficient cooling must be provided. Proper cooling of the DC/DC converter can be verified by measuring the temperature at the test point as shown in the Figure 12. The temperature at this point should not exceed the max values in the table 6.

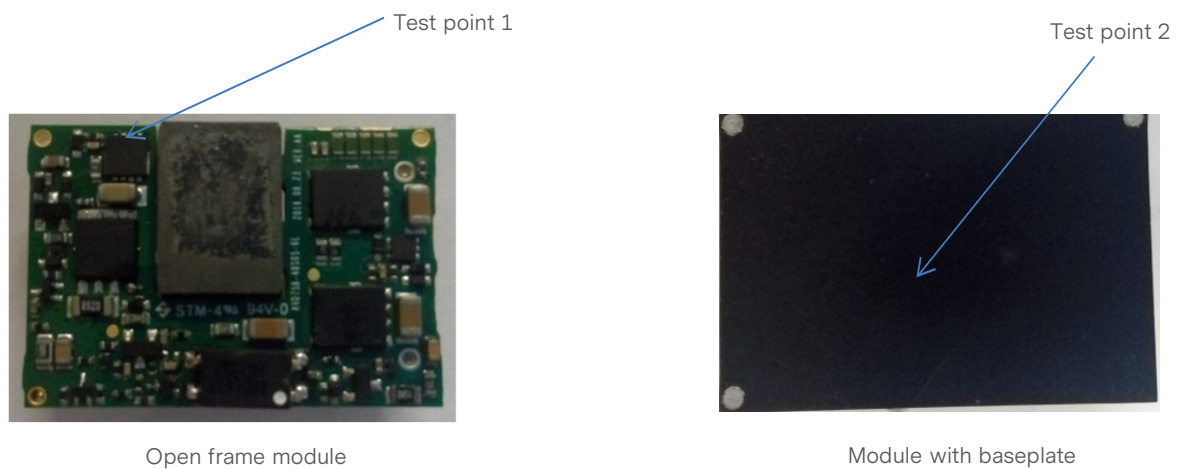
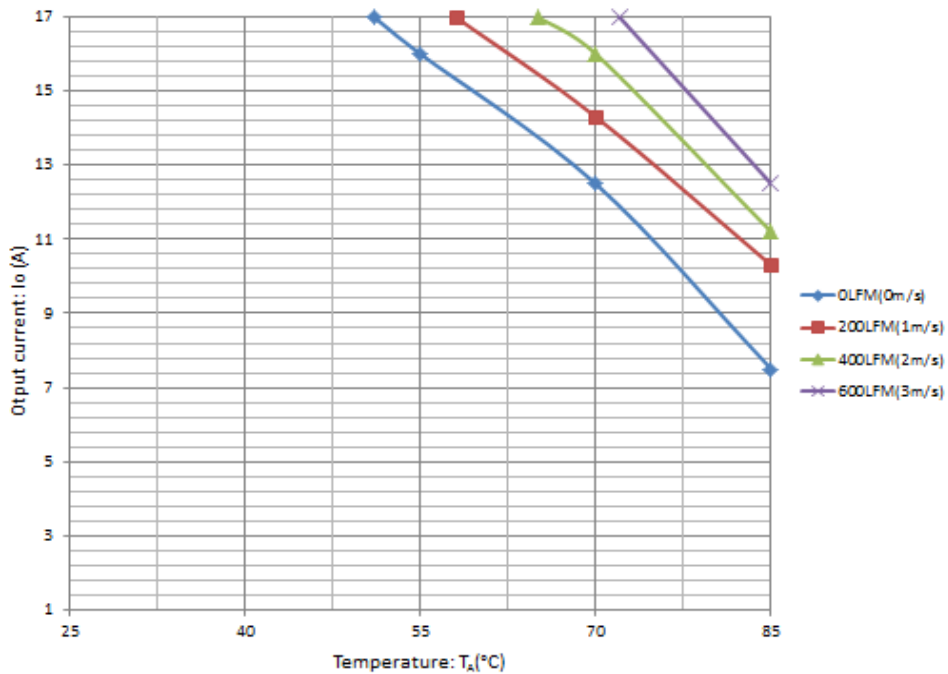

Figure 12 Temperature test point

Table 6. Temperature limit of the test point	
Test Point	Temperature limit
Test Point1	115 °C
Test Point2	120 °C

ENVIRONMENTAL SPECIFICATIONS

For a typical application, Figure 13 shows the derating of output current vs. ambient air temperature at different air velocity.



AVD85B-48S05-6L and AVD85B-48S05TL

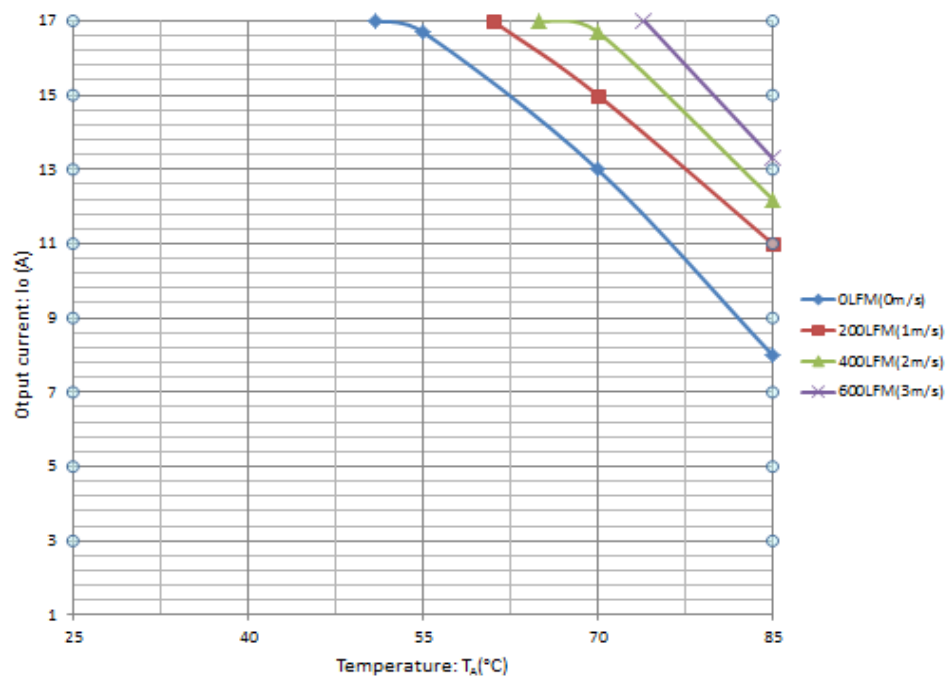

AVD85B-48S05B-6L

Figure 13 Output power derating, 48Vin, air flowing across the converter (from Vin- to Vin+)

ENVIRONMENTAL SPECIFICATIONS

Qualification Testing

Parameter	Unit (pcs)	Test condition
Halt test	4-5	$T_{a,min} -20\text{ }^{\circ}\text{C}$ to $T_{a,max} +25\text{ }^{\circ}\text{C}$, $10\text{ }^{\circ}\text{C}$ step, V_{in} = min to max, 0 ~ 100% load
Vibration	3	Frequency range: 5Hz ~ 20Hz, 20Hz ~ 200Hz, A.S.D: $1.0\text{m}^2/\text{s}^3$, -3db/oct, axes of vibration: X/Y/Z. Time: 30min/axes
Mechanical Shock	3	30g, 6ms, 3axes, 6directions, 3time/direction
Thermal Shock	3	-55 $^{\circ}\text{C}$ to 125 $^{\circ}\text{C}$, unit temperature 20cycles
Thermal Cycling	3	-40 $^{\circ}\text{C}$ to 85 $^{\circ}\text{C}$, temperature change rate: $1^{\circ}\text{C}/\text{min}$, cycles: 2cycles
Humidity	3	40 $^{\circ}\text{C}$, 95%RH, 48h
Solder Ability	15	IPC J-STD-002C-2007

APPLICATION NOTES

Typical Application

Below is the typical application of the AVD85B-48S05 series power supply.

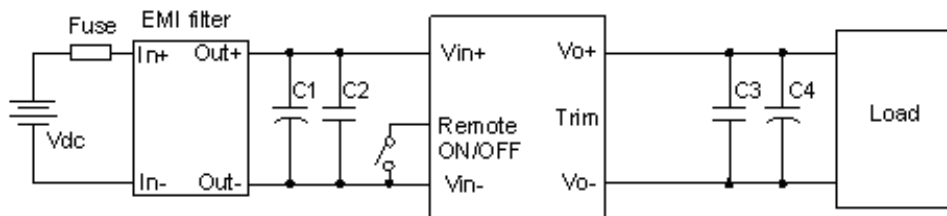

Figure 14 Typical application

C1: 100uF/100V electrolytic capacitor; P/N: UPM2A101MPD (Nichicon) or equivalent caps.

C2,C3: 1uF/100V X7R ceramic capacitor, P/N: C3216X7R2A105KT0LOS (TDK) or equivalent caps.

C4: 220uF oscon capacitor, P/N: CUXAE1C221M2BA (Sanyo).

Fuse: External fast blow fuse with a rating of 5A. The recommended fuse model is 0453005.MR from LITTLEFUSE.

Note: EMI filter see Figure 19.

APPLICATION NOTES

Remote ON/OFF

Negative remote ON/OFF logic is available in AVD85B-48S05. The logic is CMOS and TTL compatible.

The voltage between pin Remote ON/OFF and pin Vin- must not exceed the range listed in Table 3 to ensure proper operation. The external remote ON/OFF circuit is highly recommended as shown in Figure 15.

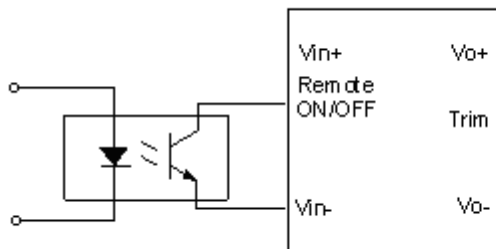

Isolated remote ON/OFF circuit

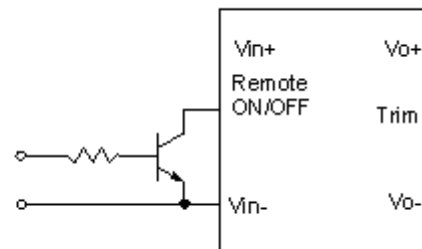

Non-isolated remote ON/OFF circuit

Figure 15 External Remote ON/OFF circuit

APPLICATION NOTES

Trim Characteristics

Connecting an external resistor between Trim pin and Vo- pin will decrease the output voltage. While connecting it between Trim and Vo+ will increase the output voltage. The following equations determine the external resistance to obtain the trimmed output voltage.

$$R_{adj-down} = \frac{510}{\Delta} - 10.2(K\Omega)$$

$$R_{adj-up} = \frac{5.1 \times V_{nom} \times (100 + \Delta)}{1.225 \times \Delta} - \frac{510}{\Delta} - 10.2(K\Omega)$$

Δ : Output rate against nominal output voltage.

$$\Delta = \frac{100 \times (V_{nom} - V_0)}{V_{nom}}$$

V_{nom} : Nominal output voltage.

For example, to get 15.5V output, the trimming resistor is

$$\Delta = \frac{100 \times (V_{nom} - V_0)}{V_{nom}} = \frac{100 \times (5.5 - 5)}{5} = 10$$

$$R_{adj-up} = \frac{5.1 \times 5 \times (100 + 10)}{1.225 \times 10} - \frac{510}{10} - 10.2 = 167.78(K\Omega)$$

When trimming up, the output current should be decreased accordingly so as not to exceed the maximum output power.

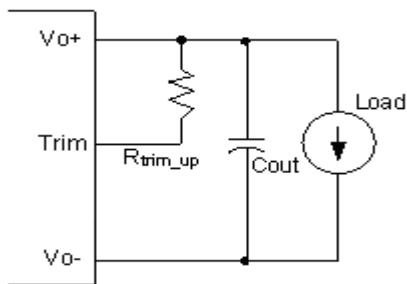

Figure 16 Trim up

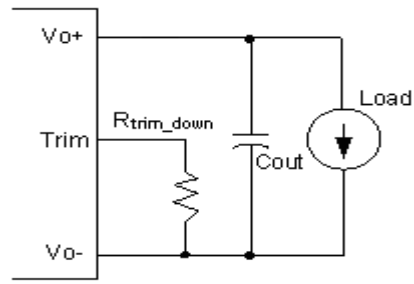

Figure 17 Trim down

If the sense compensate function is not necessary, connect S+ to Vo+ and S- to Vo- directly.

APPLICATION NOTES

Input Ripple & Inrush Current and Output Ripple & Noise Test Configuration

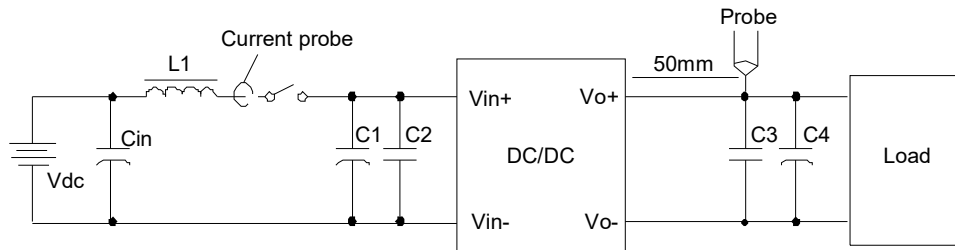

Figure 18 Input ripple & output ripple & noise test configuration

Vdc: DC power supply

L1: 12uH

Cin: 220uF/100V typical

C1 ~ C4: See Figure 14

Note: Using a coaxial cable with series 50Ω resistor and 0.68uF ceramic capacitor or a ground ring of probe to test output ripple & noise is recommended.

APPLICATION NOTES

EMC Test Conditions

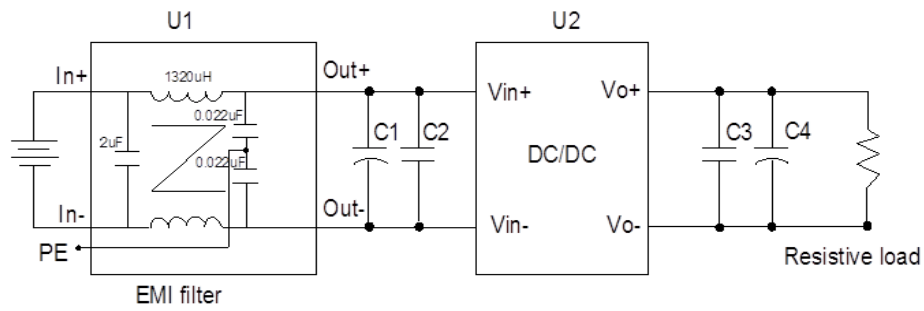

Figure 19 EMC test conditions

U1: Input EMC filter

U2: Module to test, AVD85B-48S05

C1 ~ C4: See Figure 14

SOLDERING INFORMATION

Soldering

The product is intended for standard manual or wave soldering.

	Product Requirement	Product Name
3.0	Wave soldering	AVD85B-48S05B-6L AVD85B-48S05-6L

When wave soldering is used, the temperature on pins is specified to maximum 260 °C for maximum 7s.

When soldering by hand, the iron temperature should be maintained at 300 °C ~ 380 °C and applied to the converter pins for less than 10s. Longer exposure can cause internal damage to the converter. Cleaning of solder joint can be performed with cleaning solvent IPA or simulative.

The below products are intended for standard reflow soldering.

	Product Requirement	Product Name
3.0	Reflow soldering	AVD85B-48S05-6L AVD85B-48S05TL

When reflow soldering is used, Please refer to following fig for recommended temperature profile parameters.

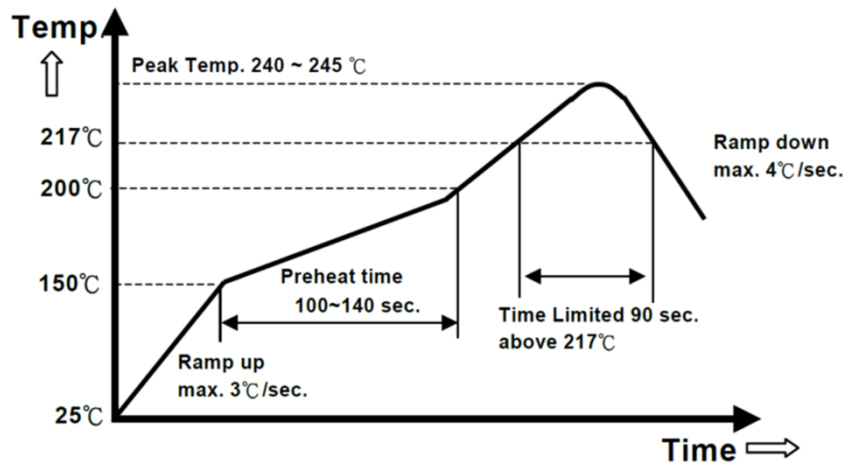

Record of Revision and Changes

Issue	Date	Description	Originators
1.0	08.04.2017	First Issue	E. Wang
1.1	12.04.2019	Update soldering information	K. Wang
1.2	06.04.2020	Update RoHS status	C.Liu
1.3	06.04.2020	Update 62368-1 cert	L.Lee
1.4	06.07.2021	Update AE Template	J.Zhang
1.5	08.29.2023	Update the product picture	L.Lee



For international contact information,
visit advancedenergy.com.

powersales@aei.com (Sales Support)
productsupport.ep@aei.com (Technical Support)
+1 888 412 7832

ABOUT ADVANCED ENERGY

Advanced Energy (AE) has devoted more than three decades to perfecting power for its global customers. AE designs and manufactures highly engineered, precision power conversion, measurement and control solutions for mission-critical applications and processes.

Our products enable customer innovation in complex applications for a wide range of industries including semiconductor equipment, industrial, manufacturing, telecommunications, data center computing, and medical. With deep applications know-how and responsive service and support across the globe, we build collaborative partnerships to meet rapid technological developments, propel growth for our customers, and innovate the future of power.

PRECISION | POWER | PERFORMANCE

Specifications are subject to change without notice. Not responsible for errors or omissions. ©2020 Advanced Energy Industries, Inc. All rights reserved. Advanced Energy®, and AE® are U.S. trademarks of Advanced Energy Industries, Inc.