

ARTESYN

AEE 10W-M SERIES

DC/DC Converter



PRODUCT DESCRIPTION

Advanced Energy's Artesyn AEE10W-M series is the new range of high performance dc-dc converter modules with a reinforced insulation system. I/O- isolation voltage is specified for 4200VACrms. The product comes in a compact 2"x1" industry standard package. All models provide Wide 2:1 input voltage range and fully regulated output voltage regulation.

The AEE10W-M DC/DC converters offer an economical solution for demanding applications in industrial and medical instrumentation requesting a certified supplementary or reinforced insulation system to comply with industrial or latest medical safety standards.

SPECIAL FEATURES

- 4200VAC reinforced Insulation
- Insulation rated for 300VAC Working Voltage
- Medical Safety to UL/CSA/EN/IEC 60601-1 3rd Edition
- 2 MOOP rated
- Wide 2:1 Input Voltage Range
- Excellent Efficiency up to 82%
- Fully regulated Output Voltage
- Low Leakage Current
- Operating Temperature Range -40°C to +85 °C (With derating)
- Input Filter meets EN 55022, Class A and FCC, level A
- Overload Protection
- 2"x 1" Plastic Package
- 3 Years Product Warranty

SAFETY

- cUL/UL60950-1, CSA C22.2 No. 60950-1-03
- UL60601-1, CSA C22.2 No.601-1
- IEC/EN 60950-1, IEC/EN 60601-1 3rd Edition, 2 MOOP
- IEC60950-1 CB report, cUL/UL 60950-1 certificate
- UL60601-1 UL certificate
- EMC Standard meets 4th Edition of EMI EN55011 and EMS EN60601-1-2

TYPICAL APPLICATIONS

- Industrial
- Medical

TECHNICAL REFERENCE NOTE

Total Power:

10 Watts

Input Voltage:

9-18 Vdc

18-36 Vdc

36-75 Vdc

of Outputs:

Single / Dual



Model Numbers

Model	Input Voltage	Output Voltage	Maximum Load	Efficiency
AEE01A12-M	9-18Vdc	5V	1.6A	76%
AEE00B12-M	9-18Vdc	12V	0.835A	80%
AEE00BB12-M	9-18Vdc	±12 V	±0.417	80%
AEE00CC12-M	9-18Vdc	±15 V	±0.333	81%
AEE02A24-M	18-36Vdc	5V	2A	77%
AEE00B24-M	18-36Vdc	12V	0.835A	81%
AEE00BB24-M	18-36Vdc	±12 V	±0.417	81%
AEE00CC24-M	18-36Vdc	±15 V	±0.333	82%
AEE02A48-M	36-75Vdc	5V	2A	77%
AEE00B48-M	36-75Vdc	12V	0.835A	81%
AEE00BB48-M	36-75Vdc	±12 V	±0.417	81%
AEE00CC48-M	36-75Vdc	±15 V	±0.333	82%

Options

Electrical Specifications

Absolute Maximum Ratings

Stress in excess of those listed in the “Absolute Maximum Ratings” may cause permanent damage to the power supply. These are stress ratings only and functional operation of the unit is not implied at these or any other conditions above those given in the operational sections of this TRN. Exposure to any absolute maximum rated condition for extended periods may adversely affect the power supply’s reliability.

Table 1. Absolute Maximum Ratings						
Parameter	Model	Symbol	Min	Typ	Max	Unit
Input Surge Voltage 1 Sec.max	12V input Models	$V_{IN,DC}$	-0.7	-	25	Vdc
	24V input Models		-0.7	-	50	Vdc
	48V input Models		-0.7	-	100	Vdc
Maximum Output Power	All	$P_{O,max}$	-	-	10	W
Isolation Voltage Input to output (60 seconds)	All models		4200 ¹	-	-	Vac
Isolation Voltage Input to output (1 second)	All models		6000	-	-	Vac
Isolation Resistance	All models		10	-	-	Gohm
Isolation Capacitance	All models		-	60	80	pF
Operating Ambient Temperature Range	Natural Convection		-40		+85	°C
Operating Case Temperature	All	T_{CASE}	-	-	+95	°C
Storage Temperature	All	T_{STG}	-50		+125	°C
Humidity (non-condensing) Operating Non-operating	All		-	-	95	%
	All		-	-	95	%
MTBF	MIL-HDBK-217F@25°C, Ground Benign		1000000	-	-	Hours

Note 1 - 300Vrms working voltage according to IEC/EN 60601-1

Note 2 - 1000Vrms working voltage according to IEC/EN 60950-1

Electrical Specifications

Input Specifications

Table 2. Input Specifications							
Parameter		Condition	Symbol	Min	Typ	Max	Unit
Operating Input Voltage, DC	12V input Models	All	$V_{IN,DC}$	9	12	18	Vdc
	24V Input Models			18	24	36	
	48V Input Models			36	48	75	
Start-Up Threshold Voltage	12V input Models	All	$V_{IN,start}$	7	8	9	Vdc
	24V Input Models			13	15	18	
	48V Input Models			30	33	36	
Under Voltage Lockout	12V input Models	All	$V_{IN,under}$	-	-	8.5	Vdc
	24V Input Models			-	-	16	
	48V Input Models			-	-	34	
Input reflected ripple current	12V input Models	0 to 500MHz,4.7uH source impedance	$I_{IN,ripple}$	-	100	-	mA
	24V Input Models			-	50	-	
	48V Input Models			-	25	-	
Input Current	AEE01A12-M	$V_{IN,DC}=V_{IN,nom}$	$I_{IN,full\ load}$	-	877	-	mA
	AEE00B12-M			-	1044	-	
	AEE00BB12-M			-	1042	-	
	AEE00CC12-M			-	1028	-	
	AEE02A24-M			-	541	-	
	AEE00B24-M			-	516	-	
	AEE00BB24-M			-	516	-	
	AEE00CC24-M			-	508	-	
	AEE02A48-M			-	271	-	
	AEE00B48-M			-	258	-	
	AEE00BB48-M			-	258	-	
AEE00CC48-M	-	254	-				
No Load Input Current (V_O On, $I_O = 0A$)	AEE01A12-M	$V_{IN,DC}=V_{IN,nom}$	I_{IN,no_load}	-	30	-	mA
	AEE00B12-M			-	30	-	
	AEE00BB12-M			-	30	-	
	AEE00CC12-M			-	30	-	
	AEE02A24-M			-	20	-	
	AEE00B24-M			-	20	-	
	AEE00BB24-M			-	20	-	
	AEE00CC24-M			-	20	-	
	AEE02A48-M			-	10	-	
	AEE00B48-M			-	10	-	
	AEE00BB48-M			-	10	-	
AEE00CC48-M	-	10	-				

Electrical Specifications

Input Specifications

Table 2. Input Specifications con't							
Parameter		Condition	Symbol	Min	Typ	Max	Unit
Efficiency @Max. Load	AEE01A12-M	$V_{IN,DC}=V_{IN,nom}$ $I_O=I_{O,max}$ $T_A=25\text{ }^{\circ}\text{C}$	η	-	76%	-	%
	AEE00B12-M			-	80%	-	
	AEE00BB12-M			-	80%	-	
	AEE00CC12-M			-	81%	-	
	AEE02A24-M			-	77%	-	
	AEE00B24-M			-	81%	-	
	AEE00BB24-M			-	81%	-	
	AEE00CC24-M			-	82%	-	
	AEE02A48-M			-	77%	-	
	AEE00B48-M			-	81%	-	
	AEE00BB48-M			-	81%	-	
	AEE00CC48-M			-	82%	-	
Leakage current	All Modules	$V_{IN,DC}=240\text{Vdc}$ $F=60\text{HZ}$	$I_{leakage}$	-	-	10	μA
Short circuit input power	All Modules			-	-	3000	mW
Internal Power Dissipation	All Modules			-	-	4000	mW
Internal Filter Type		All		Internal LC Filter (for EN55022,Class A)			

Electrical Specifications

Output Specifications

Table 3. Output Specifications							
Parameter		Condition	Symbol	Min	Typ	Max	Unit
Output Voltage Set-Point	AEE01A12-M	$V_{IN,DC} = V_{IN,nom}$ $I_O = I_{O,max}$ $T_A = 25\text{ }^\circ\text{C}$	V_O	-	5V	-	Vdc
	AEE00B12-M			-	12V	-	
	AEE00BB12-M			-	$\pm 12\text{ V}$	-	
	AEE00CC12-M			-	$\pm 15\text{ V}$	-	
	AEE02A24-M			-	5V	-	
	AEE00B24-M			-	12V	-	
	AEE00BB24-M			-	$\pm 12\text{ V}$	-	
	AEE00CC24-M			-	$\pm 15\text{ V}$	-	
	AEE02A48-M			-	5V	-	
	AEE00B48-M			-	12V	-	
	AEE00BB48-M			-	$\pm 12\text{ V}$	-	
	AEE00CC48-M			-	$\pm 15\text{ V}$	-	
Output Current	AEE01A12-M	Convection cooling	I_O	-	-	1.6A	A
	AEE00B12-M			-	-	0.835A	
	AEE00BB12-M			-	-	± 0.417	
	AEE00CC12-M			-	-	± 0.333	
	AEE02A24-M			-	-	2A	
	AEE00B24-M			-	-	0.835A	
	AEE00BB24-M			-	-	± 0.417	
	AEE00CC24-M			-	-	± 0.333	
	AEE02A48-M			-	-	2A	
	AEE00B48-M			-	-	0.835A	
	AEE00BB48-M			-	-	± 0.417	
	AEE00CC48-M			-	-	± 0.333	
V_O Load Capacitance	AEE01A12-M	All		-	-	1000	μF
	AEE00B12-M			-	-	470	
	AEE00BB12-M			-	-	220	
	AEE00CC12-M			-	-	220	
	AEE02A24-M			-	-	1000	
	AEE00B24-M			-	-	470	
	AEE00BB24-M			-	-	220	
	AEE00CC24-M			-	-	220	
	AEE02A48-M			-	-	1000	
	AEE00B48-M			-	-	470	
	AEE00BB48-M			-	-	220	
	AEE00CC48-M			-	-	220	

Electrical Specifications

Output Specifications

Table 3. Output Specifications Con't							
Parameter		Condition	Symbol	Min	Typ	Max	Unit
V _O Load Capacitance	AEE01A12-M	All		-	-	1000	uF
	AEE00B12-M			-	-	470	
	AEE00BB12-M			-	-	220	
	AEE00CC12-M			-	-	220	
	AEE02A24-M			-	-	1000	
	AEE00B24-M			-	-	470	
	AEE00BB24-M			-	-	220	
	AEE00CC24-M			-	-	220	
	AEE02A48-M			-	-	1000	
	AEE00B48-M			-	-	470	
	AEE00BB48-M			-	-	220	
	AEE00CC48-M			-	-	220	
Line Regulation		V _{IN,DC} = V _{IN,min} to V _{IN,max}	±%V _O	-	0.3	0.5	%
Load Regulation		I _O = I _{O,min} to I _{O,max}	±%V _O	-	0.5	1.2	%
Switching Frequency		All	f _{sw}	120	150	180	KHz
V _O Dynamic Response	Peak Deviation	25% load change	±%V _O	-	3	5	%
	Settling Time		t _s	-	250	-	uSec
Temperature Coefficient		All	%/°C	-	0.02	0.05	%
Output Over Current Protection ¹		All	%I _{O,max}	120	150	-	%
Output Short Circuit Protection		All		Hiccup Automatic Recovery			

Note 1 - Hiccup Automatic Recovery

Electrical Specifications

AEE01A12-M Performance Curves

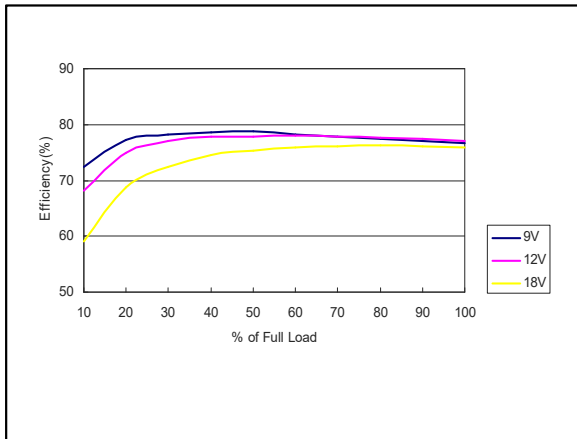

Figure 1: AEE01A12-M Efficiency Versus Output Current Curve
 Vin = 9 to 18Vdc Load: Io = 0 to 1.6A

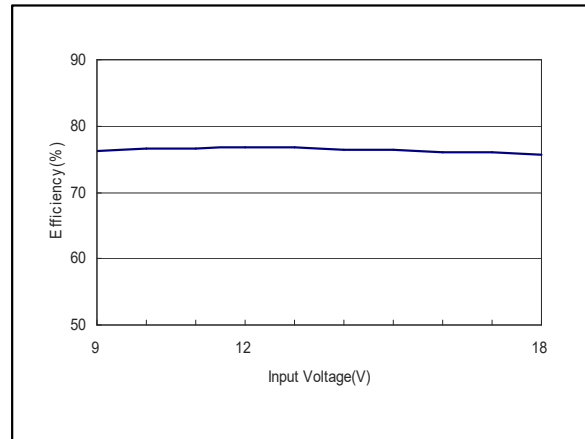

Figure 2: AEE01A12-M Efficiency Versus Input Voltage Curve
 Vin = 9 to 18Vdc Load: Io = 1.6A

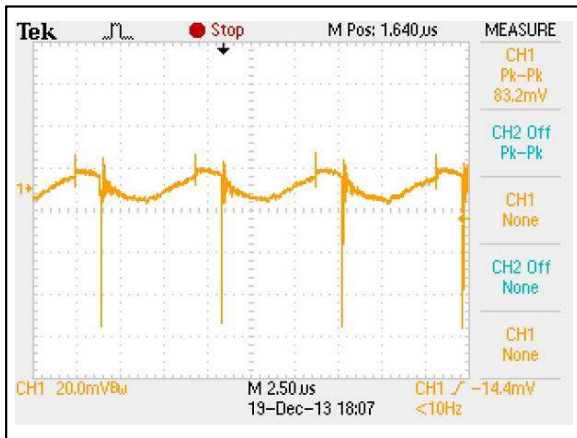

Figure 3: AEE01A12-M Ripple and Noise Measurement
 Vin = 12Vdc Load: Io = 1.6A
 Ch 1: Vo

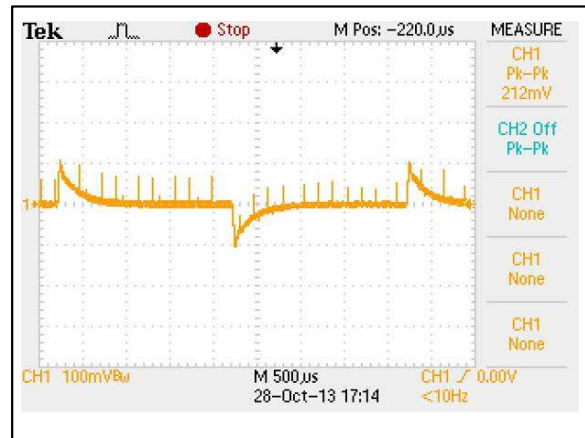

Figure 4: AEE01A12-M Transient Response
 Vin = 12Vdc Load: Io = 100% to 75% load change
 Ch 1: Vo

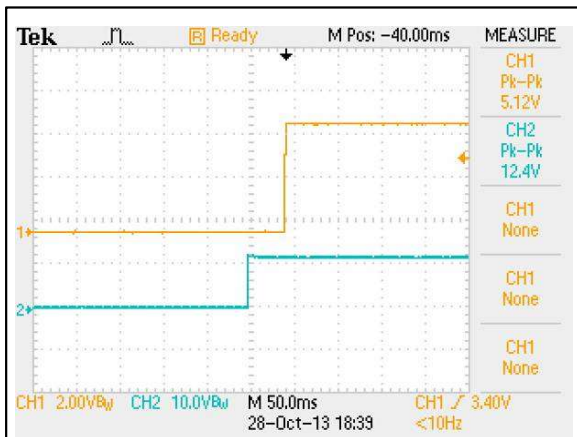

Figure 5: AEE01A12-M Output Voltage Startup Characteristic by Vin
 Vin = 12Vdc Load: Io = 1.6A
 Ch 1: Vo Ch 2: Vin

Electrical Specifications

AEE01A12-M Performance Curves

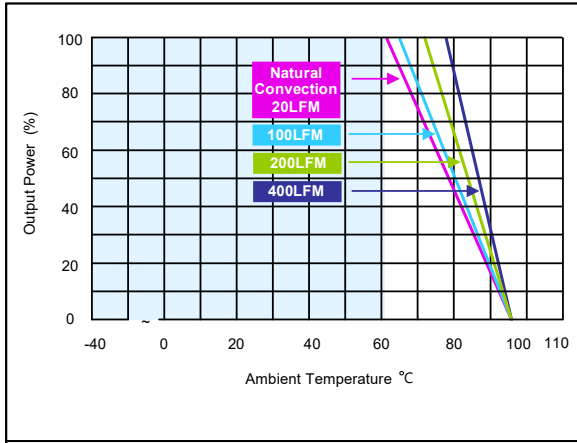

Figure 6: AEE01A12-M Derating Curves (without heatsink)
 Vin = 12Vdc Load: Io = 0 to 1.6A

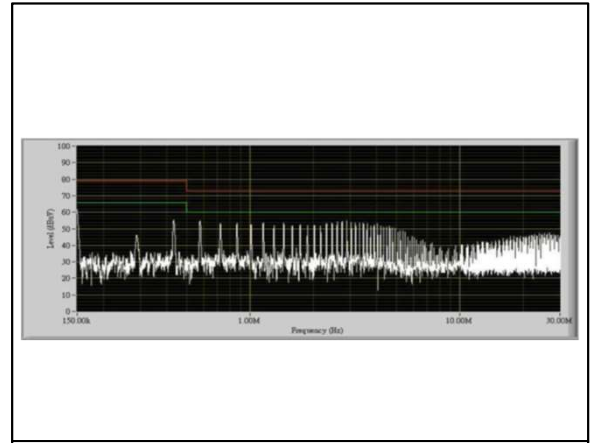

Figure 7: AEE01A12-M Conduction Emission of EN550122 Class A
 Vin = 12Vdc Load: Io = 1.6A

Note - All test conditions are at 25 °C

Electrical Specifications

AEE00B12-M Performance Curves

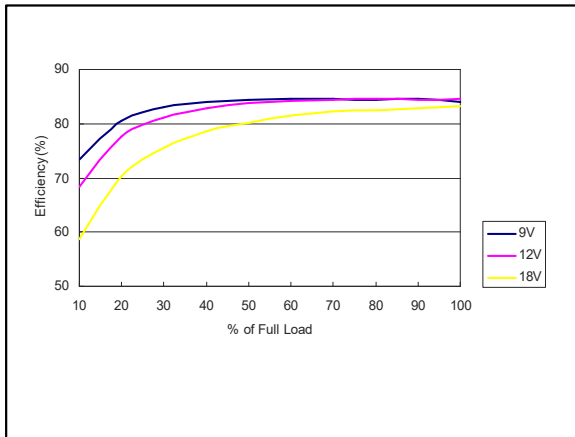

Figure 8: AEE00B12-M Efficiency Versus Output Current Curve
 Vin = 9 to 18Vdc Load: Io = 0 to 0.835A

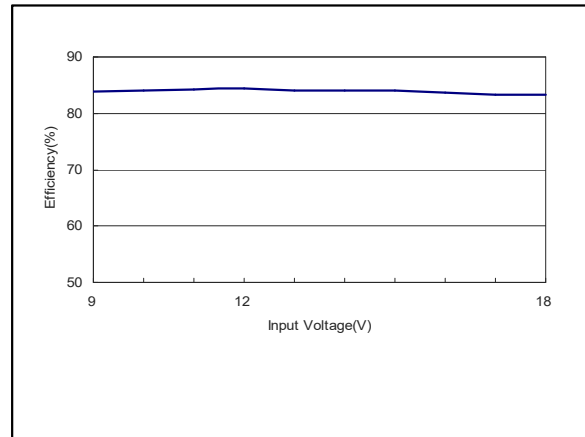

Figure 9: AEE00B12-M Efficiency Versus Input Voltage Curve
 Vin = 9 to 18Vdc Load: Io = 0.835A

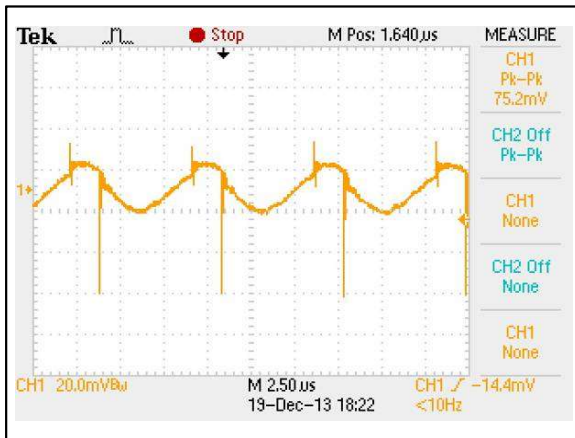

Figure 10: AEE00B12-M Ripple and Noise Measurement
 Vin = 12Vdc Load: Io = 0.835A
 Ch 1: Vo

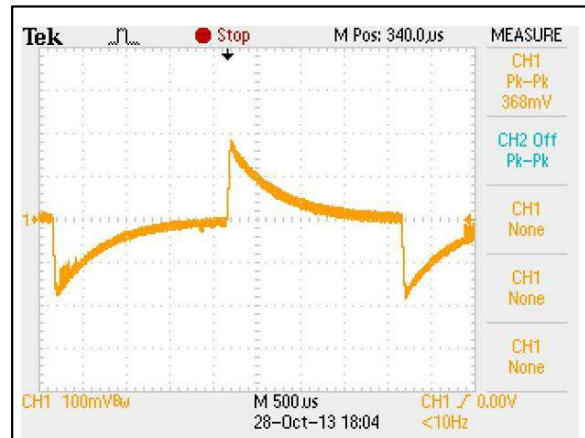

Figure 11: AEE00B12-M Transient Response
 Vin = 12Vdc Load: Io = 100% to 75% load change
 Ch 1: Vo

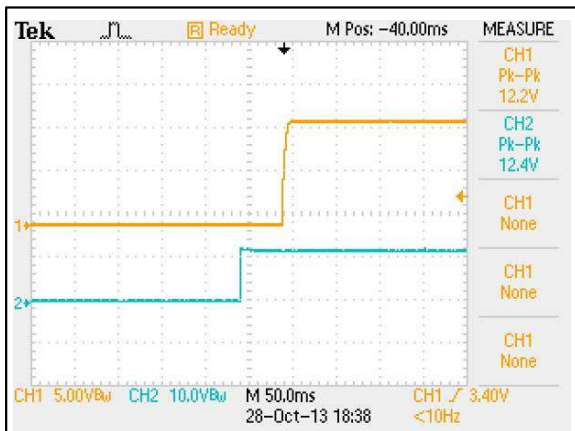

Figure 12: AEE00B12-M Output Voltage Startup Characteristic by Vin
 Vin = 12Vdc Load: Io = 0.835A
 Ch 1: Vo Ch 2: Vin

Electrical Specifications

AEE00B12-M Performance Curves

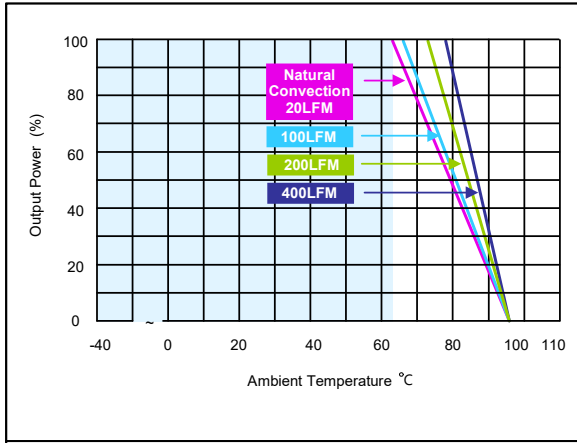

Figure 13: AEE00B12-M Derating Curves (without heatsink)
 Vin = 12Vdc Load: Io = 0 to 0.835A

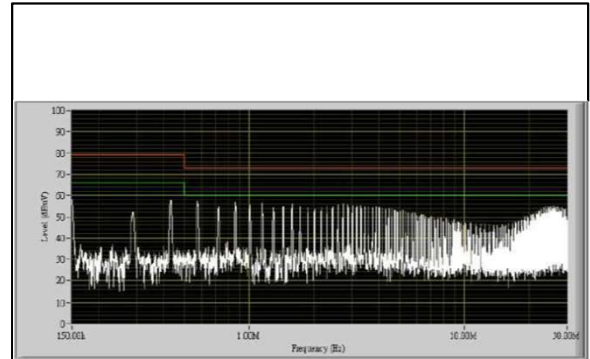

Figure 14: AEE00B12-M Conduction Emission of EN550122 Class A
 Vin = 12Vdc Load: Io = 0.835A

Note - All test conditions are at 25 °C

Electrical Specifications

AEE00BB12-M Performance Curves

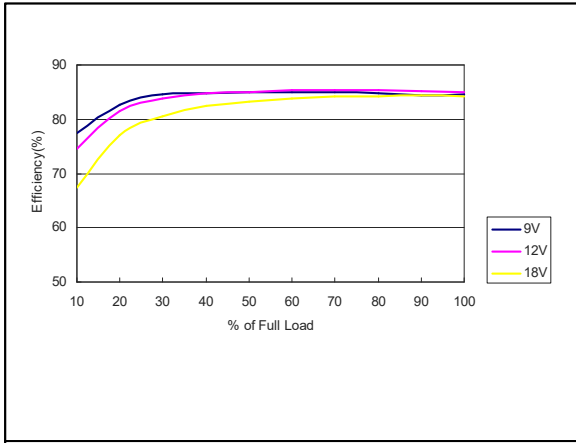

Figure 15: AEE00BB12-M Efficiency Versus Output Current Curve
 Vin = 9 to 18Vdc Load: Io = 0 to ±0.417A

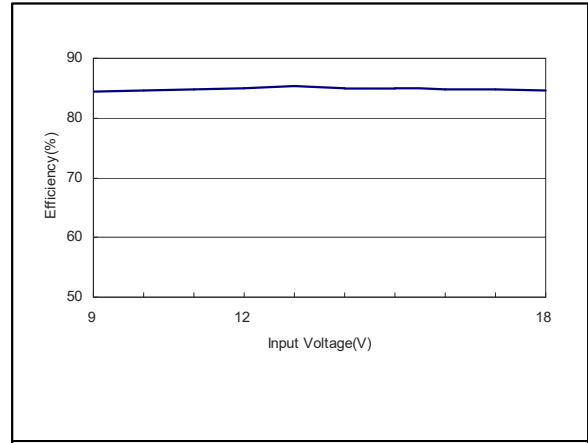

Figure 16: AEE00BB12-M Efficiency Versus Input Voltage Curve
 Vin = 9 to 18Vdc Load: Io = ±0.417A

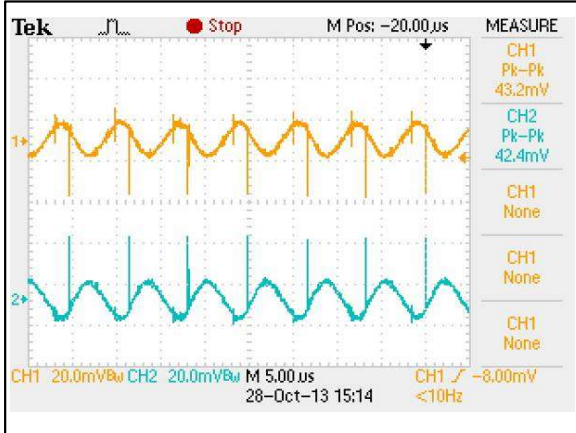

Figure 17: AEE00BB12-M Ripple and Noise Measurement
 Vin = 12Vdc Load: Io = ±0.417A
 Ch 1: Vo1 Ch 2: Vo2

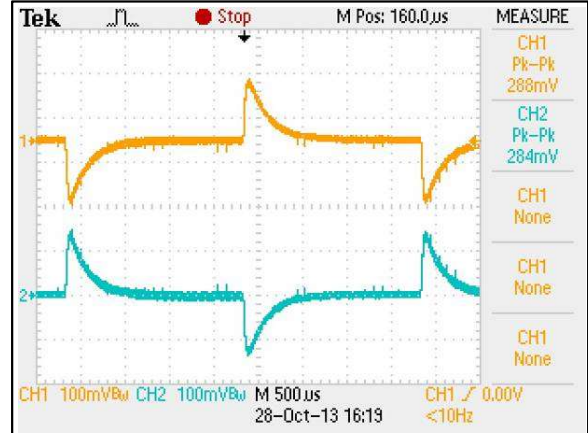

Figure 18: AEE00BB12-M Transient Response
 Vin = 12Vdc Load: Io = 100% to 75% load change
 Ch 1: Vo1 Ch 2: Vo2

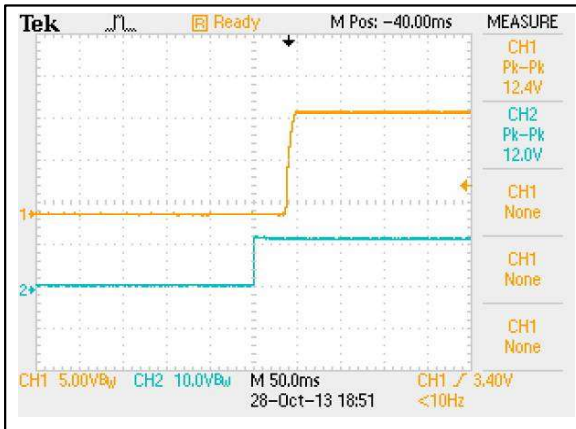

Figure 19: AEE00BB12-M Output Voltage Startup Characteristic by Vin
 Vin = 12Vdc Load: Io = ±0.417A
 Ch 1: Vo1 Ch 2: Vin

Electrical Specifications

AEE00BB12-M Performance Curves

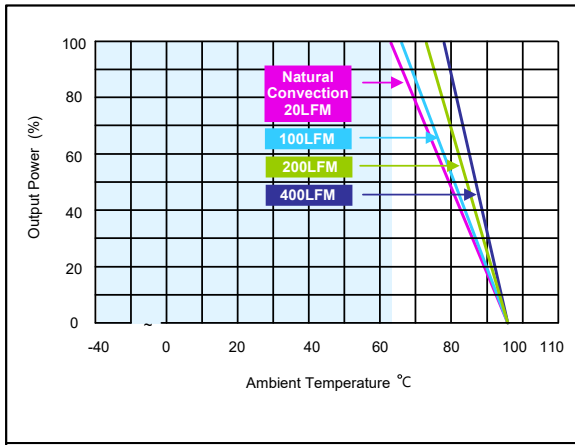

Figure 20: AEE00BB12-M Derating Curves (without heatsink)
 Vin = 12Vdc Load: Io = 0 to ±0.417A

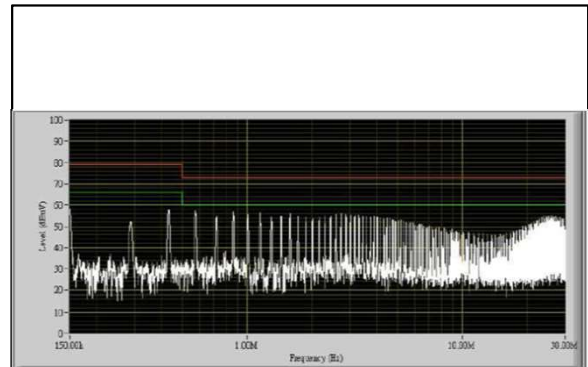

Figure 21: AEE00BB12-M Conduction Emission of EN550122 Class A
 Vin = 12Vdc Load: Io = ±0.417A

Note - All test conditions are at 25 °C

Electrical Specifications

AEE00CC12-M Performance Curves

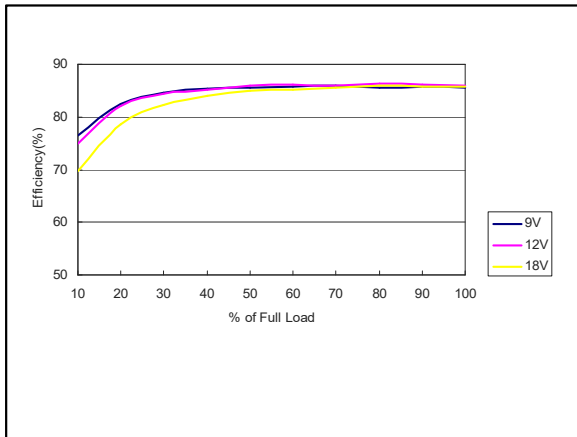

Figure 22: AEE00CC12-M Efficiency Versus Output Current Curve
 Vin = 9 to 18Vdc Load: Io = 0 to ±0.333A

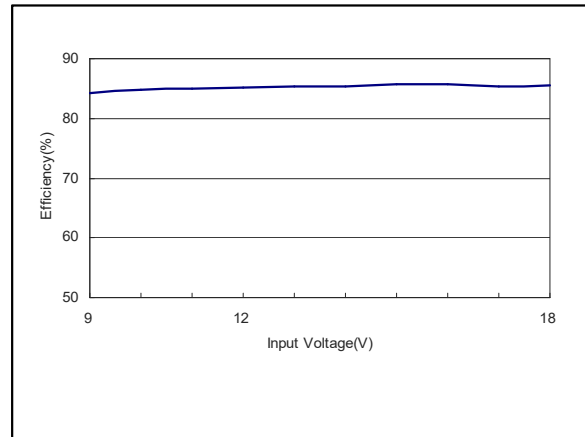

Figure 23: AEE00CC12-M Efficiency Versus Input Voltage Curve
 Vin = 9 to 18Vdc Load: Io = ±0.333A

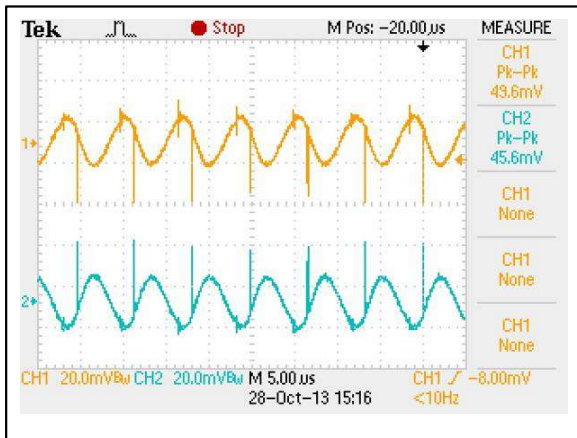

Figure 24: AEE00CC12-M Ripple and Noise Measurement
 Vin = 12Vdc Load: Io = ±0.333A
 Ch 1: Vo1 Ch 2: Vo2

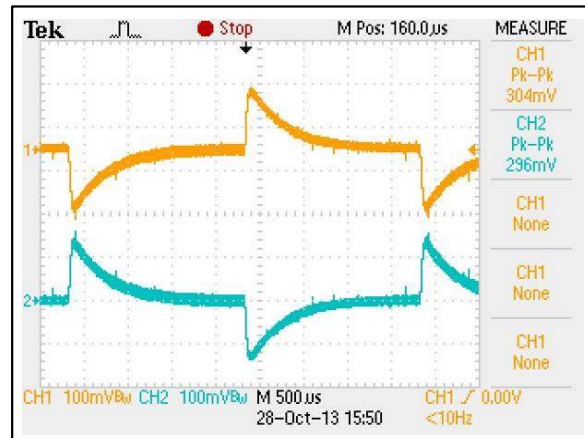

Figure 25: AEE00CC12-M Transient Response
 Vin = 12Vdc Load: Io = 100% to 75% load change
 Ch 1: Vo1 Ch 2: Vo2

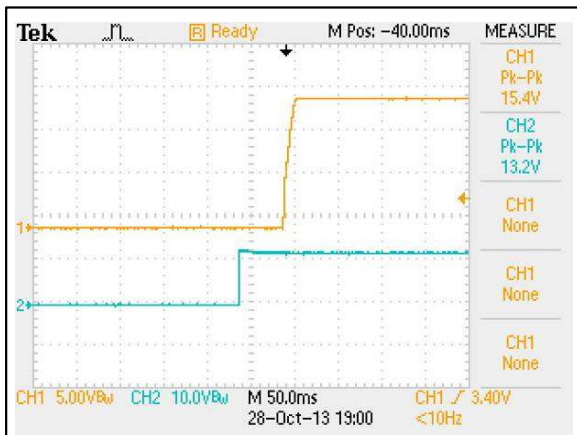

Figure 26: AEE00CC12-M Output Voltage Startup Characteristic by Vin
 Vin = 12Vdc Load: Io = ±0.333A
 Ch 1: Vo1 Ch 2: Vin

Electrical Specifications

AEE00CC12-M Performance Curves

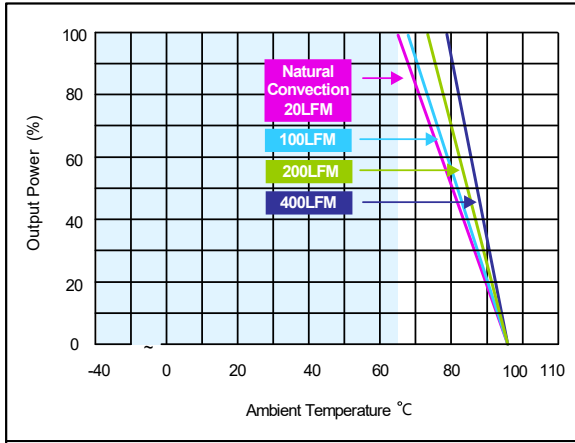

Figure 27: AEE00CC12-M Derating Curves (without heatsink)
 Vin = 12Vdc Load: Io = 0 to ±0.333A

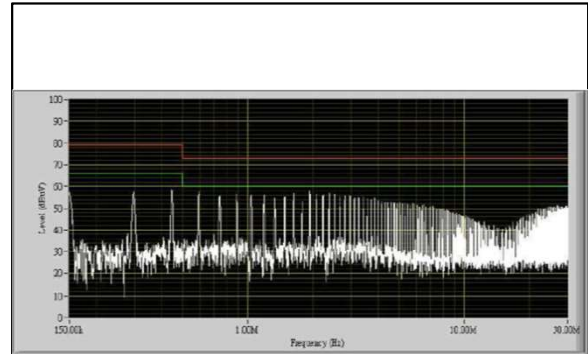

Figure 28: AEE00CC12-M Conduction Emission of EN550122 Class A
 Vin = 12Vdc Load: Io = ±0.333A

Note - All test conditions are at 25 °C

Electrical Specifications

AEE02A24-M Performance Curves

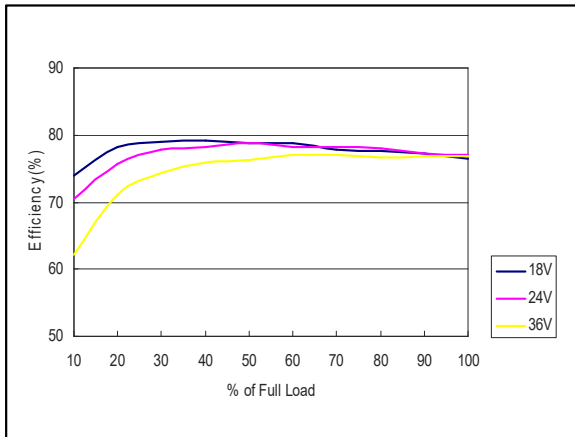

Figure 29: AEE02A24-M Efficiency Versus Output Current Curve
 Vin = 18 to 36Vdc Load: Io = 0 to 2A

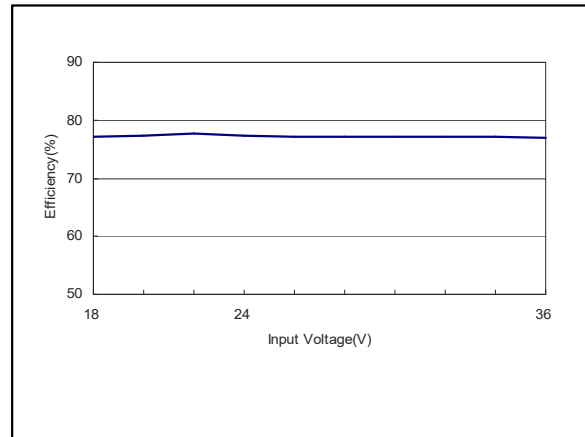

Figure 30: AEE02A24-M Efficiency Versus Input Voltage Curve
 Vin = 18 to 36Vdc Load: Io = 2A

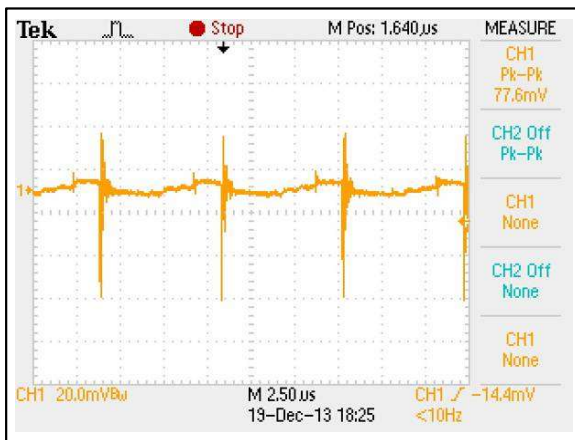

Figure 31: AEE02A24-M Ripple and Noise Measurement
 Vin = 24Vdc Load: Io = 2A
 Ch 1: Vo

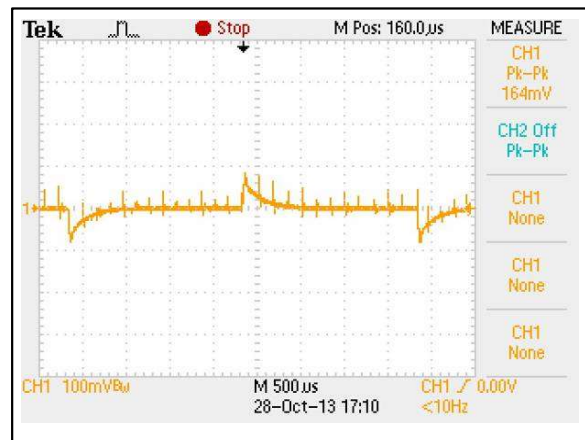

Figure 32: AEE02A24-M Transient Response
 Vin = 24Vdc Load: Io = 100% to 75% load change
 Ch 1: Vo

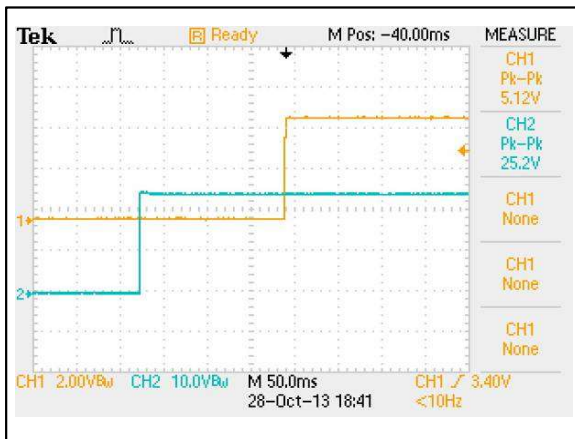

Figure 33: AEE02A24-M Output Voltage Startup Characteristic by Vin
 Vin = 24Vdc Load: Io = 2A
 Ch 1: Vo Ch 2: Vin

Electrical Specifications

AEE02A24-M Performance Curves

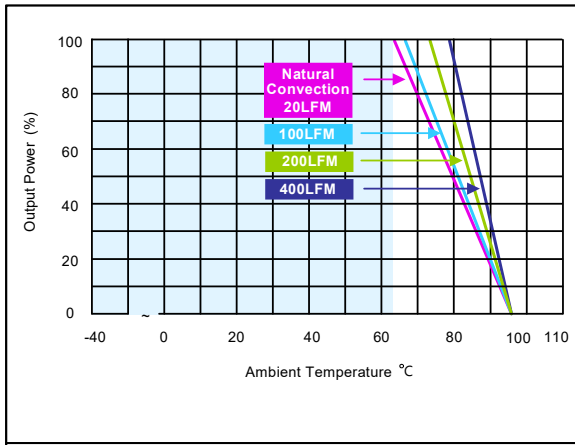

Figure 34: AEE02A24-M Derating Curves (without heatsink)
 Vin = 24Vdc Load: Io = 0 to 2A

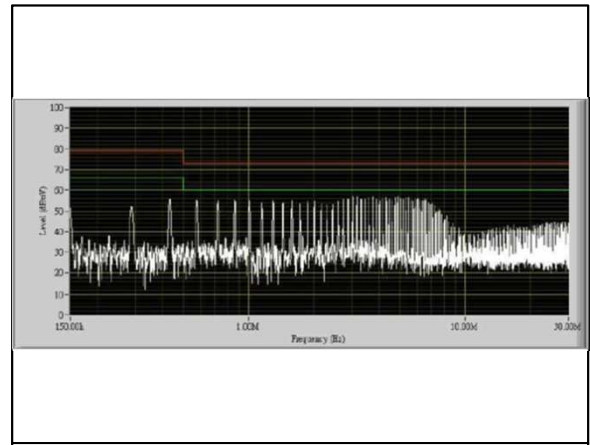

Figure 35: AEE02A24-M Conduction Emission of EN550122 Class A
 Vin = 24Vdc Load: Io = 2A

Note - All test conditions are at 25 °C

Electrical Specifications

AEE00B24-M Performance Curves

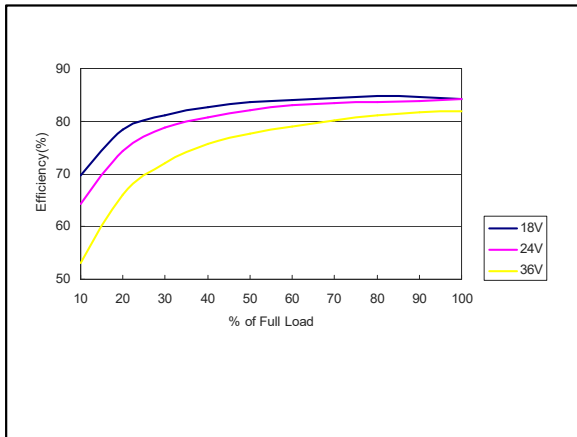

Figure 36: AEE00B24-M Efficiency Versus Output Current Curve
 Vin = 18 to 36Vdc Load: Io = 0 to 0.835A

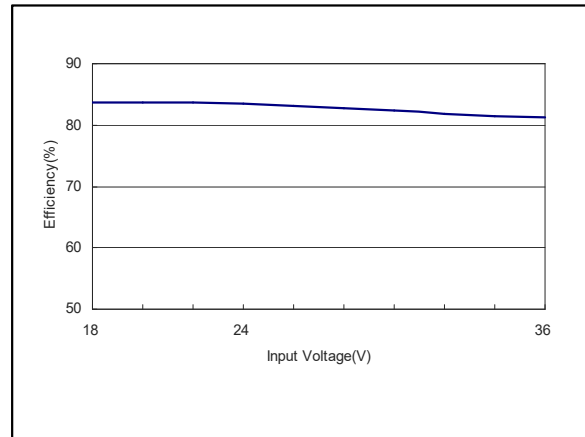

Figure 37: AEE00B24-M Efficiency Versus Input Voltage Curve
 Vin = 18 to 36Vdc Load: Io = 0.835A

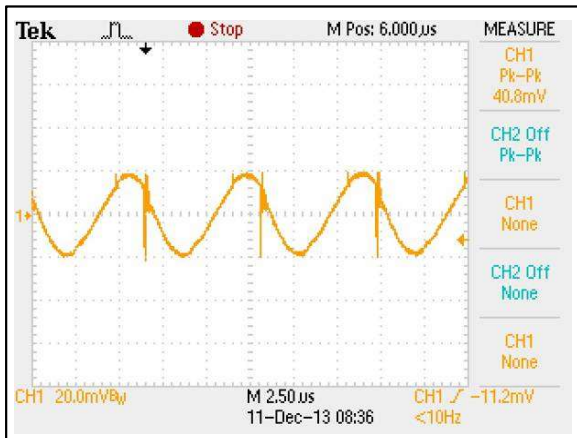

Figure 38: AEE00B24-M Ripple and Noise Measurement
 Vin = 24Vdc Load: Io = 0.835A
 Ch 1: Vo

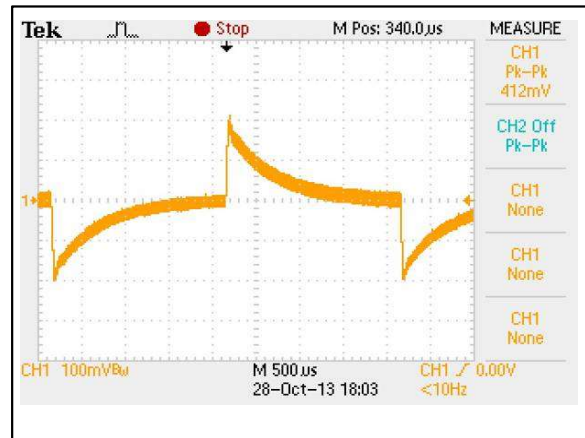

Figure 39: AEE00B24-M Transient Response
 Vin = 24Vdc Load: Io = 100% to 75% load change
 Ch 1: Vo

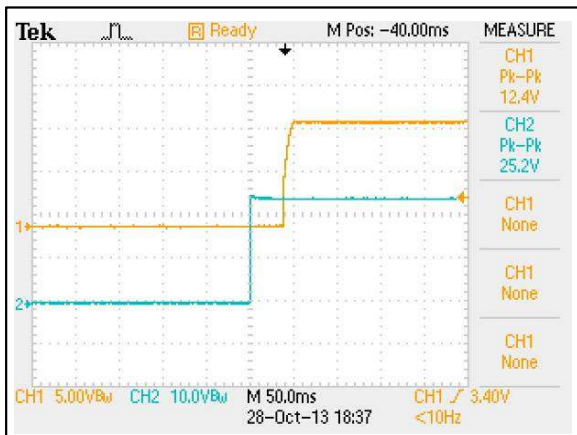

Figure 40: AEE00B24-M Output Voltage Startup Characteristic by Vin
 Vin = 24Vdc Load: Io = 0.835A
 Ch 1: Vo Ch 2: Vin

Electrical Specifications

AEE00B24-M Performance Curves

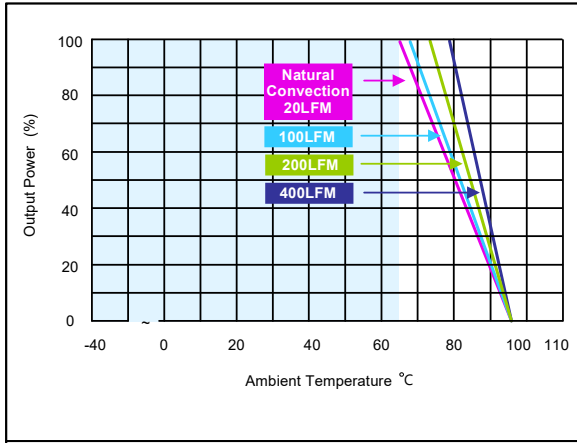

Figure 41: AEE00B24-M Derating Curves (without heatsink)
 Vin = 24Vdc Load: Io = 0 to 0.835A

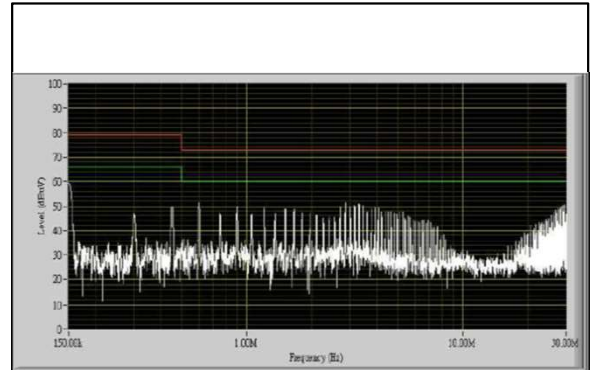

Figure 42: AEE00B24-M Conduction Emission of EN550122 Class A
 Vin = 24Vdc Load: Io = 0.835A

Note - All test conditions are at 25 °C

Electrical Specifications

AEE00BB24-M Performance Curves

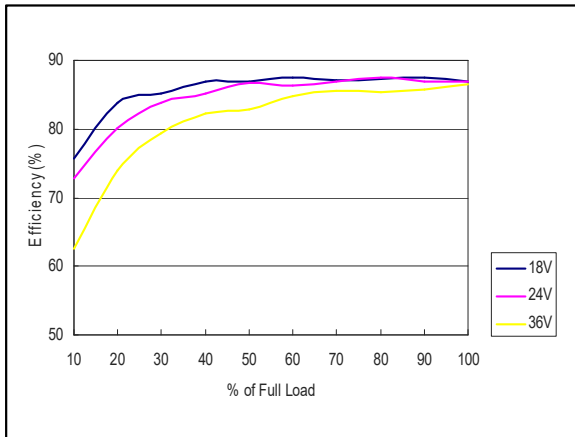

Figure 43: AEE00BB24-M Efficiency Versus Output Current Curve
 Vin = 18 to 36Vdc Load: Io = 0 to ±0.417A

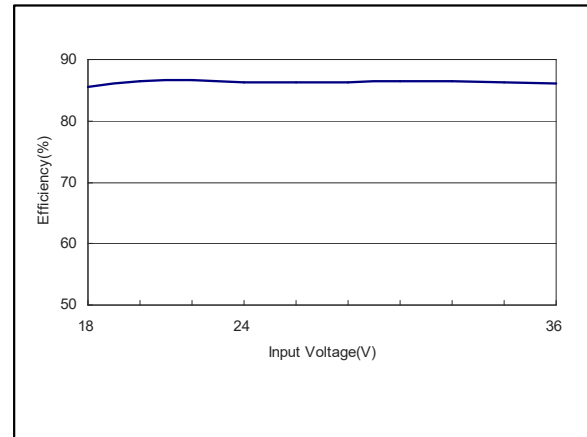

Figure 44: AEE00BB24-M Efficiency Versus Input Voltage Curve
 Vin = 18 to 36Vdc Load: Io = ±0.417A

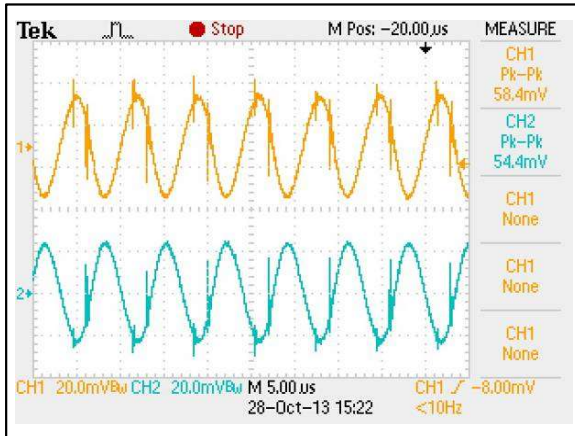

Figure 45: AEE00BB24-M Ripple and Noise Measurement
 Vin = 24Vdc Load: Io = ±0.417A
 Ch 1: Vo1 Ch 2: Vo2

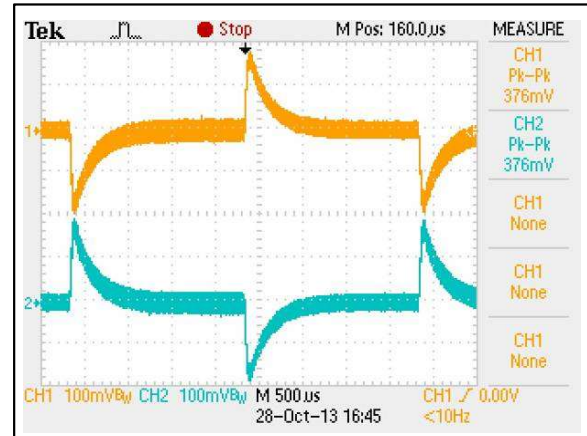

Figure 46: AEE00BB24-M Transient Response
 Vin = 24Vdc Load: Io = 100% to 75% load change
 Ch 1: Vo1 Ch 2: Vo2

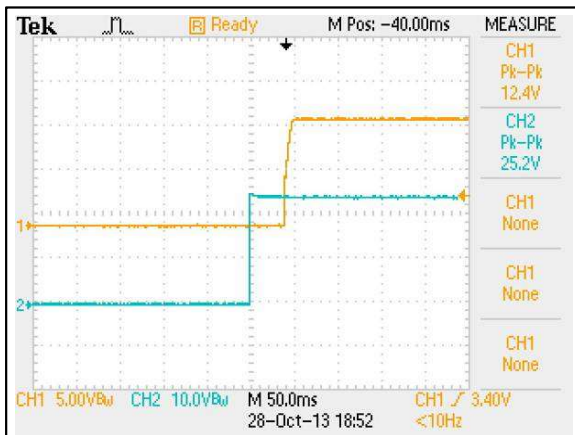

Figure 47: AEE00BB24-M Output Voltage Startup Characteristic by Vin
 Vin = 24Vdc Load: Io = ±0.417A
 Ch 1: Vo1 Ch 2: Vin

Electrical Specifications

AEE00BB24-M Performance Curves

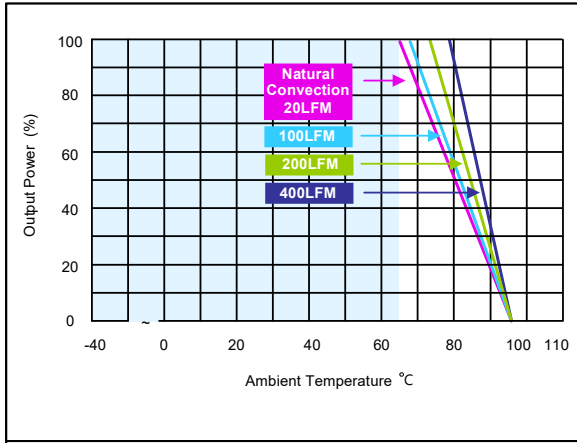

Figure 48: AEE00BB24-M Derating Curves (without heatsink)
 Vin = 24Vdc Load: Io = 0 to ±0.417A

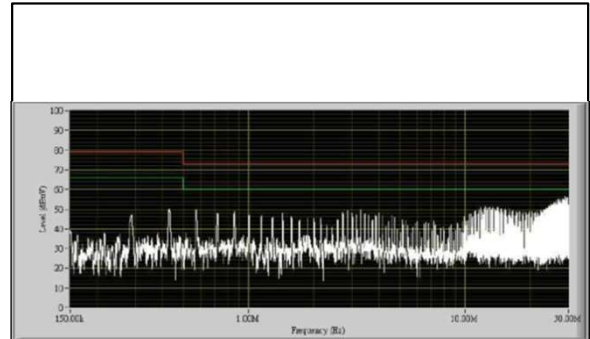

Figure 49: AEE00BB24-M Conduction Emission of EN550122 Class A
 Vin = 24Vdc Load: Io = ±0.417A

Note - All test conditions are at 25 °C

Electrical Specifications

AEE00CC24-M Performance Curves

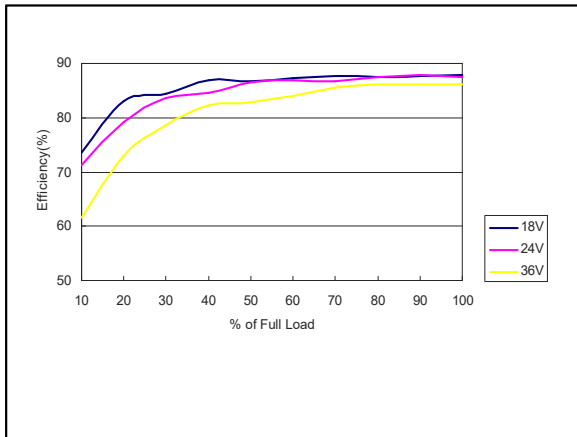

Figure 50: AEE00CC24-M Efficiency Versus Output Current Curve
 Vin = 18 to 36Vdc Load: Io = 0 to ±0.333A

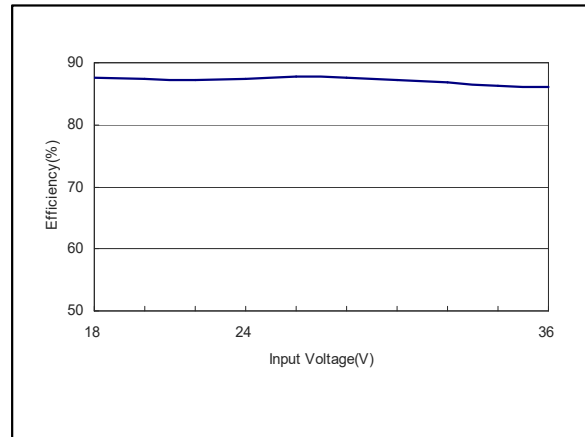

Figure 51: AEE00CC24-M Efficiency Versus Input Voltage Curve
 Vin = 18 to 36Vdc Load: Io = ±0.333A

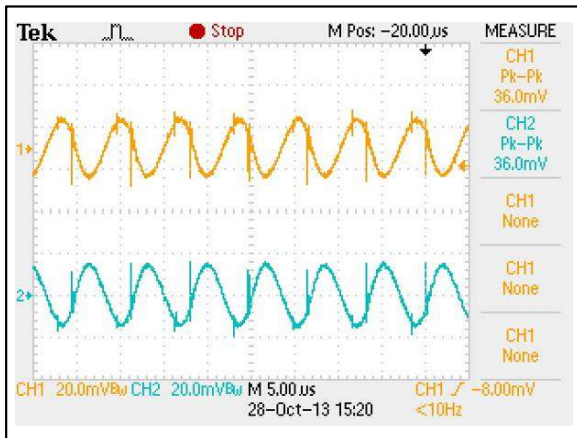

Figure 52: AEE00CC24-M Ripple and Noise Measurement
 Vin = 24Vdc Load: Io = ±0.333A
 Ch 1: Vo1 Ch 2: Vo2

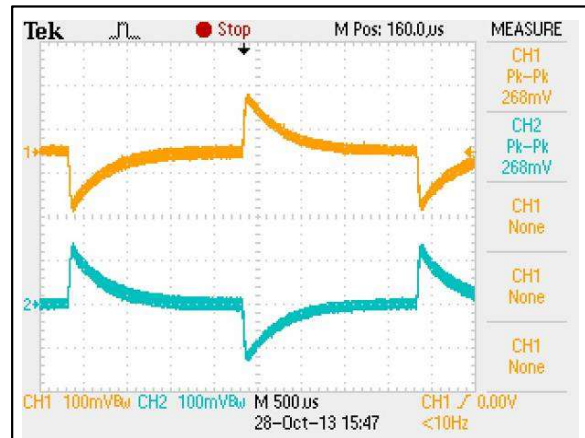

Figure 53: AEE00CC24-M Transient Response
 Vin = 24Vdc Load: Io = 100% to 75% load change
 Ch 1: Vo1 Ch 2: Vo2

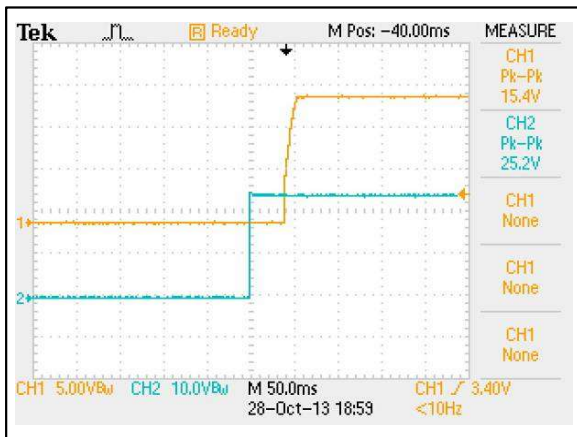

Figure 54: AEE00CC24-M Output Voltage Startup Characteristic by Vin
 Vin = 24Vdc Load: Io = ±0.333A
 Ch 1: Vo1 Ch 2: Vin

Electrical Specifications

AEE00CC24-M Performance Curves

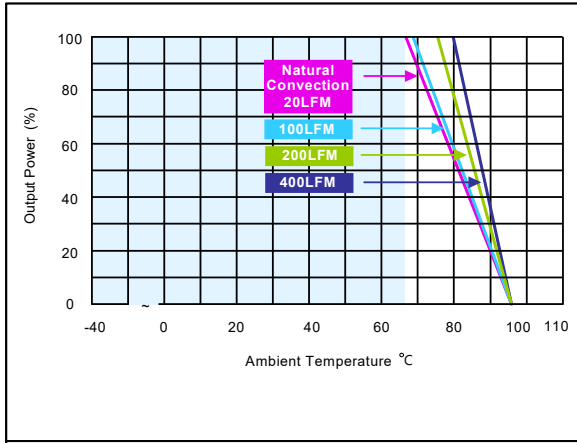

Figure 55: AEE00CC24-M Derating Curves (without heatsink)
 Vin = 24Vdc Load: Io = 0 to ±0.333A

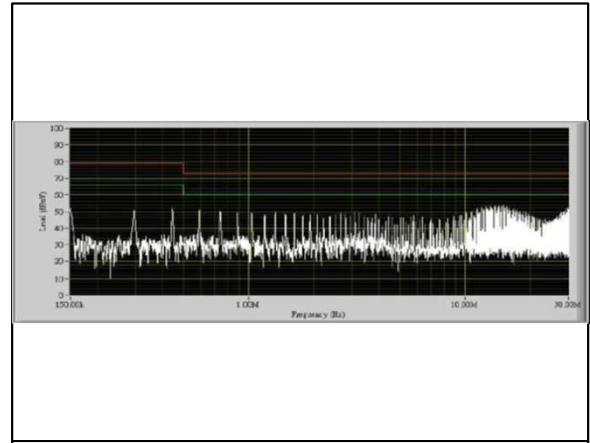

Figure 56: AEE00CC24-M Conduction Emission of EN550122 Class A
 Vin = 24Vdc Load: Io = ±0.333A

Note - All test conditions are at 25 °C

Electrical Specifications

AEE02A48-M Performance Curves

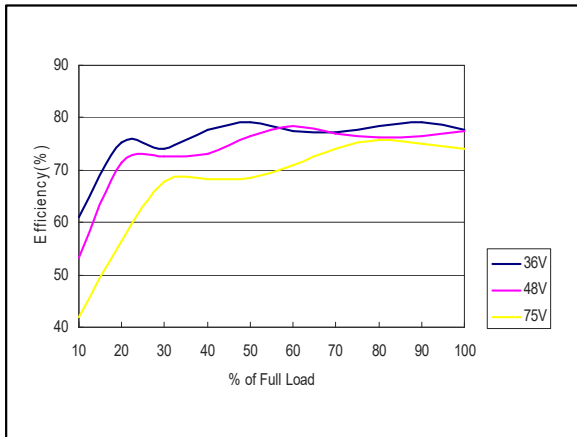

Figure 57: AEE02A48-M Efficiency Versus Output Current Curve
 Vin = 36 to 75Vdc Load: Io = 0 to 2A

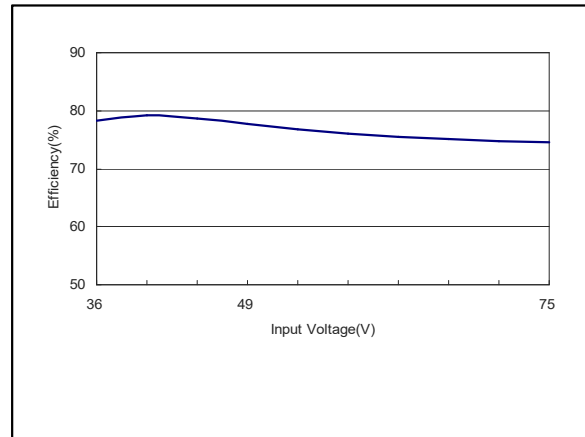

Figure 58: AEE02A48-M Efficiency Versus Input Voltage Curve
 Vin = 36 to 75Vdc Load: Io = 2A

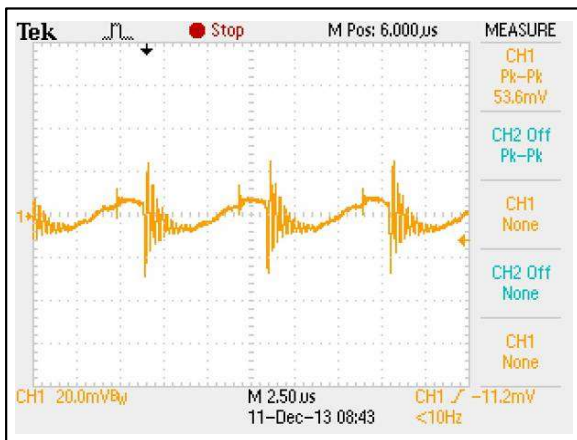

Figure 59: AEE02A48-M Ripple and Noise Measurement
 Vin = 48Vdc Load: Io = 2A
 Ch 1: Vo

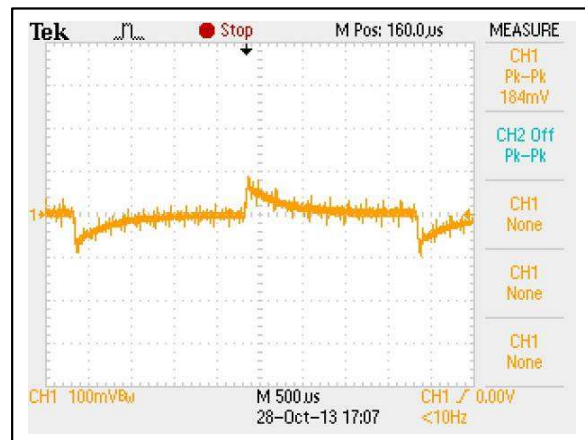

Figure 60: AEE02A48-M Transient Response
 Vin = 48Vdc Load: Io = 100% to 75% load change
 Ch 1: Vo

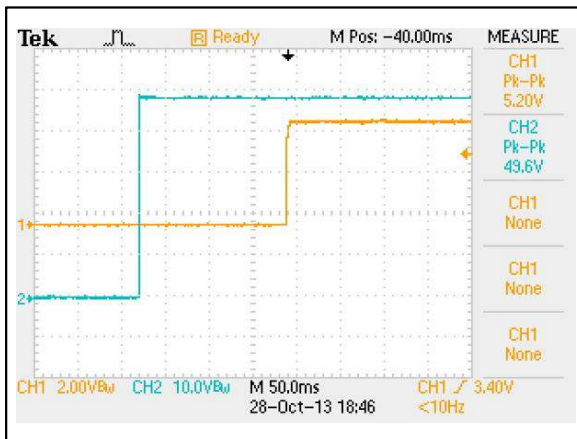

Figure 61: AEE02A48-M Output Voltage Startup Characteristic by Vin
 Vin = 48Vdc Load: Io = 2A
 Ch 1: Vo Ch 2: Vin

Electrical Specifications

AEE02A48-M Performance Curves

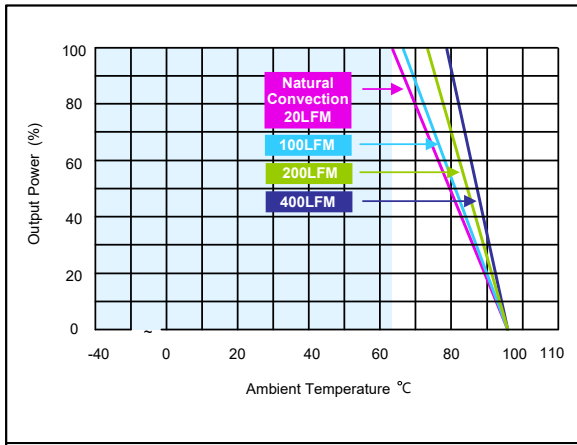

Figure 62: AEE02A48-M Derating Curves (without heatsink)
 Vin = 48Vdc Load: Io = 0 to 2A

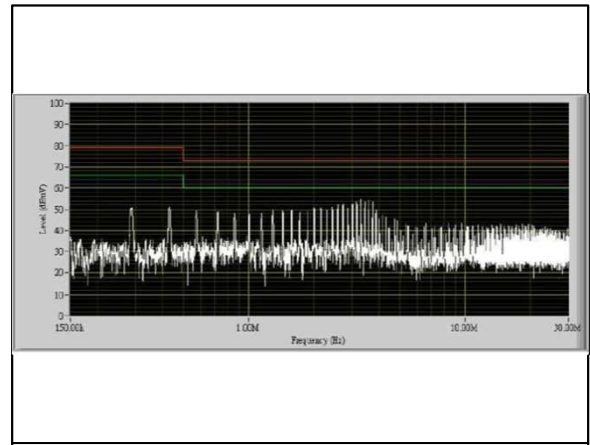

Figure 63: AEE02A48-M Conduction Emission of EN550122 Class A
 Vin = 48Vdc Load: Io = 2A

Note - All test conditions are at 25 °C

Electrical Specifications

AEE00B48-M Performance Curves

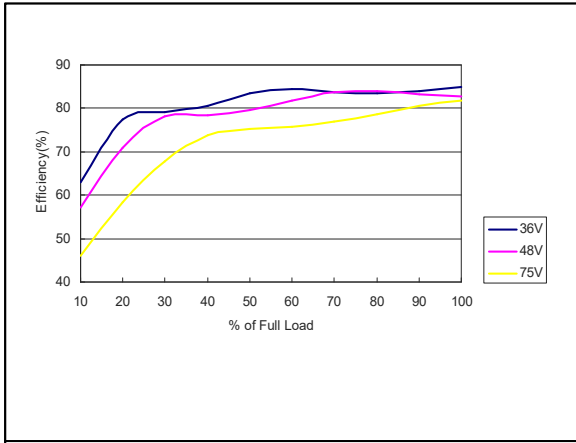

Figure 64: AEE00B48-M Efficiency Versus Output Current Curve
 Vin = 36 to 75Vdc Load: Io = 0 to 0.835A

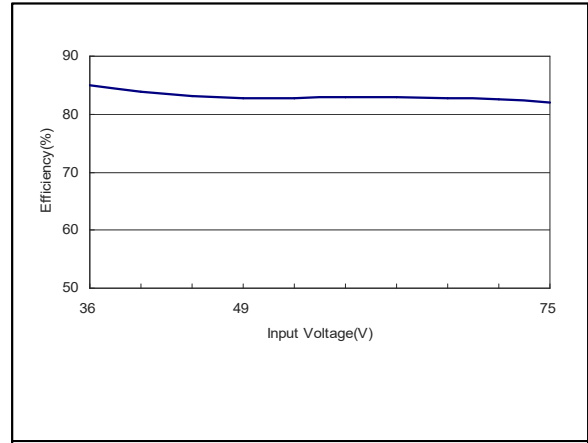

Figure 65: AEE00B48-M Efficiency Versus Input Voltage Curve
 Vin = 36 to 75Vdc Load: Io = 0.835A

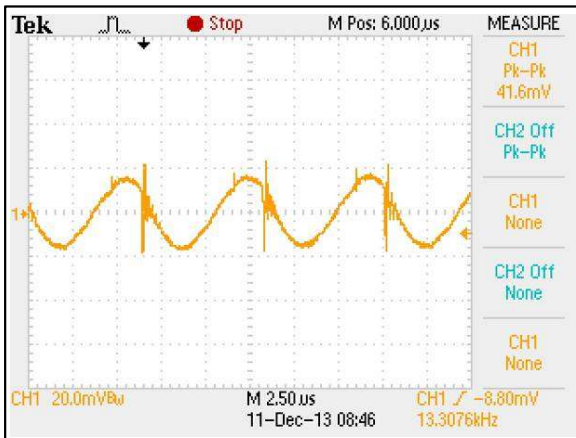

Figure 66: AEE00B48-M Ripple and Noise Measurement
 Vin = 48Vdc Load: Io = 0.835A
 Ch 1: Vo

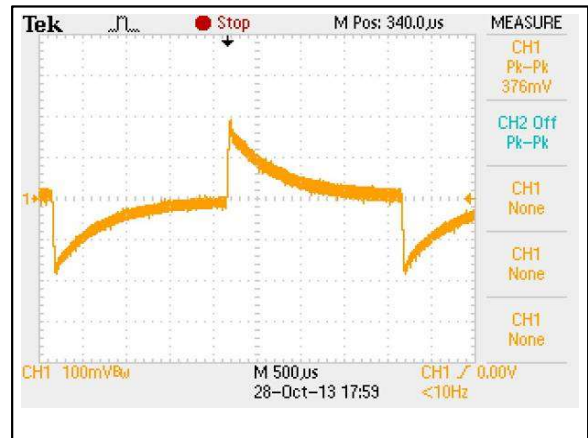

Figure 67: AEE00B48-M Transient Response
 Vin = 48Vdc Load: Io = 100% to 75% load change
 Ch 1: Vo

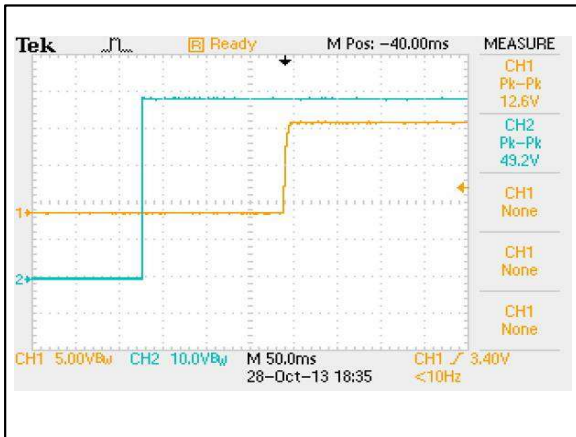

Figure 68: AEE00B48-M Output Voltage Startup Characteristic by Vin
 Vin = 48Vdc Load: Io = 0.835A
 Ch 1: Vo Ch 2: Vin

Electrical Specifications

AEE00B48-M Performance Curves

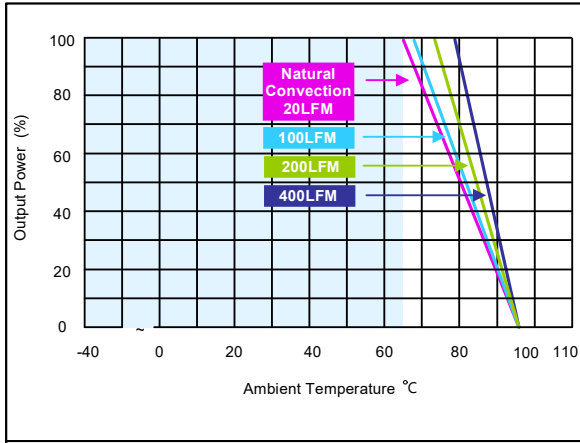

Figure 69: AEE00B48-M Derating Curves (without heatsink)
 Vin = 48Vdc Load: Io = 0 to 0.835A

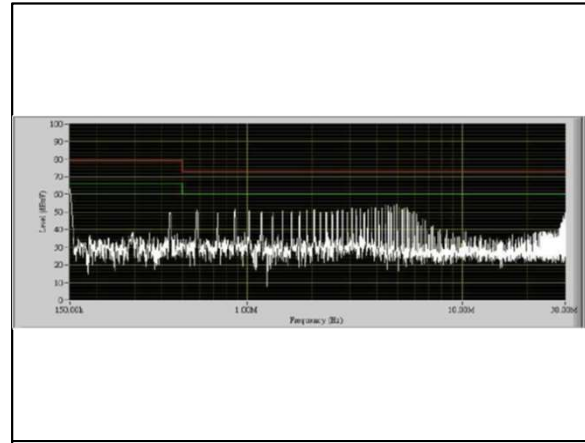

Figure 70: AEE00B48-M Conduction Emission of EN550122 Class A
 Vin = 48Vdc Load: Io = 0.835A

Note - All test conditions are at 25 °C

Electrical Specifications

AEE00BB48-M Performance Curves

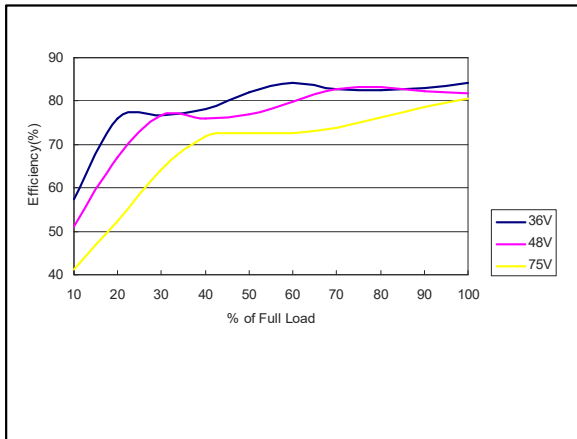

Figure 71: AEE00BB48-M Efficiency Versus Output Current Curve
 Vin = 36 to 75Vdc Load: Io = 0 to ±0.417A

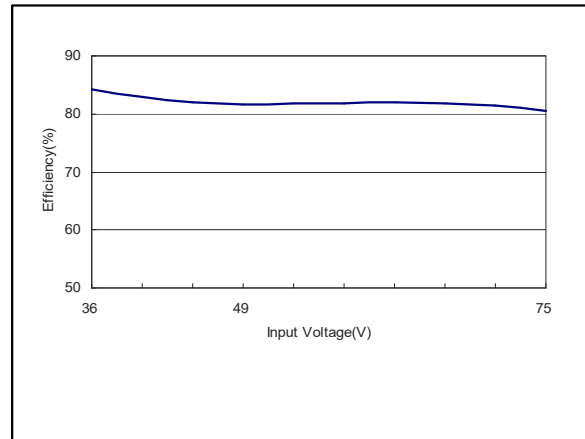

Figure 72: AEE00BB48-M Efficiency Versus Input Voltage Curve
 Vin = 36 to 75Vdc Load: Io = ±0.417A

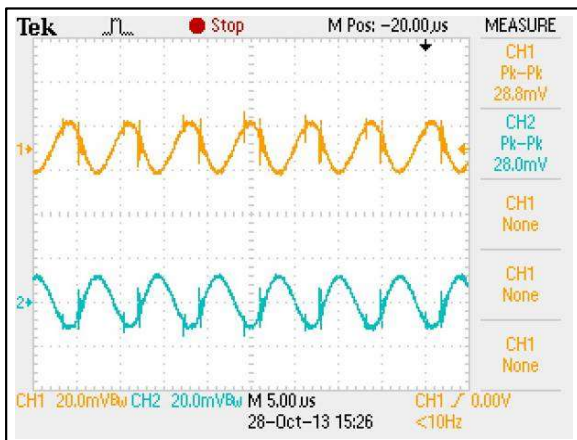

Figure 73: AEE00BB48-M Ripple and Noise Measurement
 Vin = 48Vdc Load: Io = ±0.417A
 Ch 1: Vo1 Ch 2: Vo2

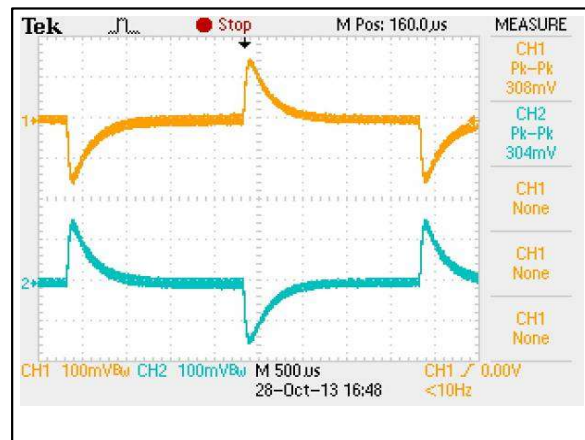

Figure 74: AEE00BB48-M Transient Response
 Vin = 48Vdc Load: Io = 100% to 75% load change
 Ch 1: Vo1 Ch 2: Vo2

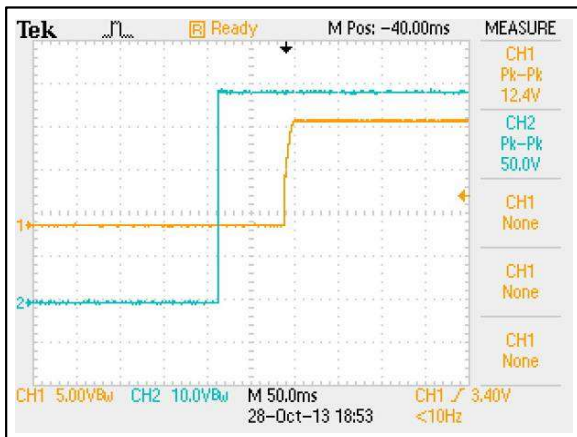

Figure 75: AEE00BB48-M Output Voltage Startup Characteristic by Vin
 Vin = 48Vdc Load: Io = ±0.417A
 Ch 1: Vo1 Ch 2: Vin

Electrical Specifications

AEE00BB48-M Performance Curves

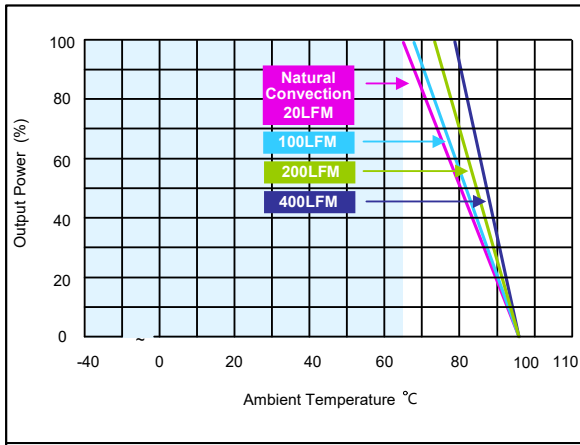

Figure 76: AEE00BB48-M Derating Curves (without heatsink)
 Vin = 48Vdc Load: Io = 0 to ±0.417A

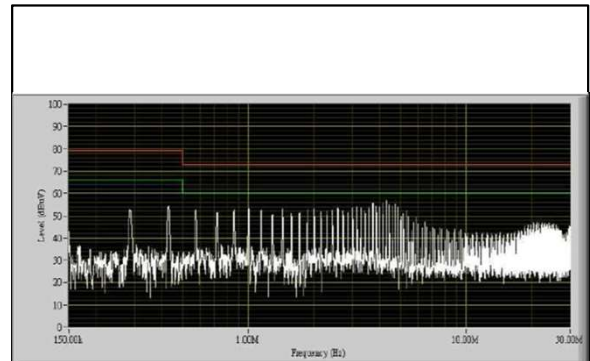

Figure 77: AEE00BB48-M Conduction Emission of EN550122 Class A
 Vin = 48Vdc Load: Io = ±0.417A

Note - All test conditions are at 25 °C

Electrical Specifications

AEE00CC48-M Performance Curves

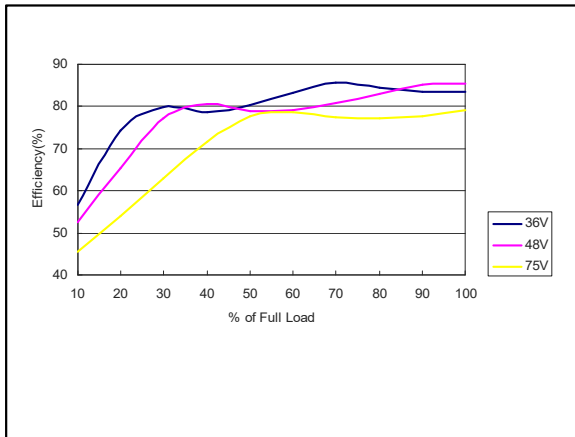

Figure 78: AEE00CC48-M Efficiency Versus Output Current Curve
 Vin = 36 to 75Vdc Load: Io = 0 to ±0.333A

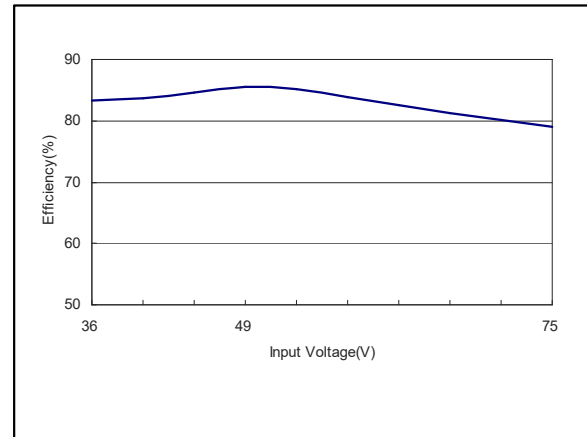

Figure 79: AEE00CC48-M Efficiency Versus Input Voltage Curve
 Vin = 36 to 75Vdc Load: Io = ±0.333A

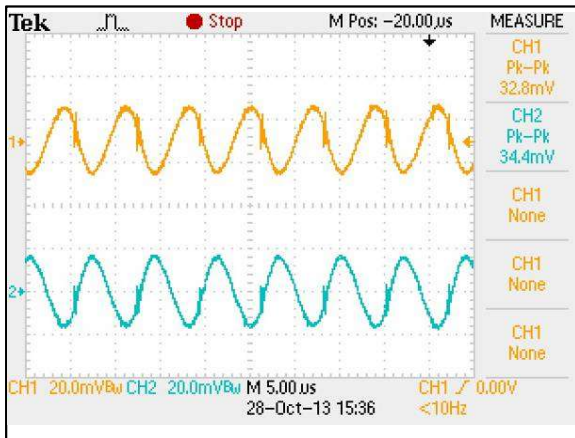

Figure 80: AEE00CC48-M Ripple and Noise Measurement
 Vin = 48Vdc Load: Io = ±0.333A
 Ch 1: Vo1 Ch 2: Vo2

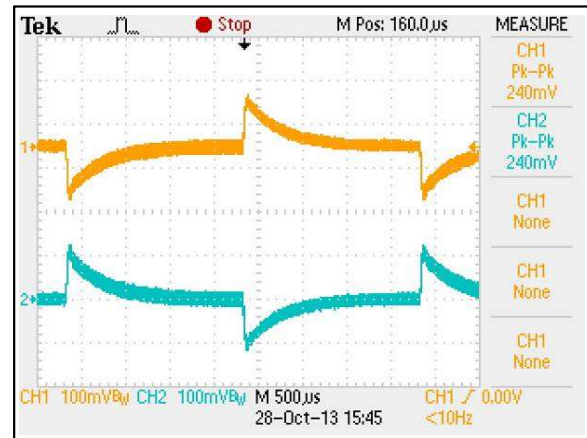

Figure 81: AEE00CC48-M Transient Response
 Vin = 48Vdc Load: Io = 100% to 75% load change
 Ch 1: Vo1 Ch 2: Vo2

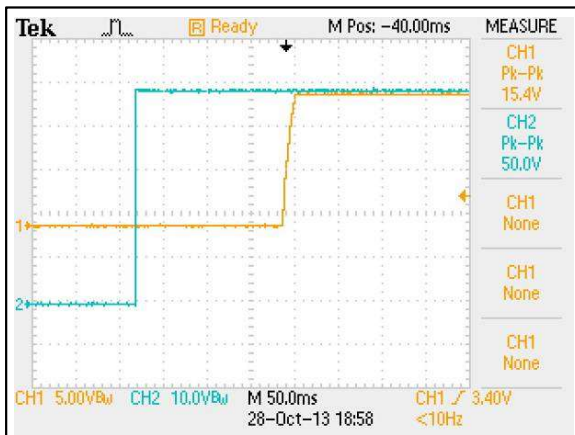

Figure 82: AEE00CC48-M Output Voltage Startup Characteristic by Vin
 Vin = 48Vdc Load: Io = ±0.333A
 Ch 1: Vo1 Ch 2: Vin

Electrical Specifications

AEE00CC48-M Performance Curves

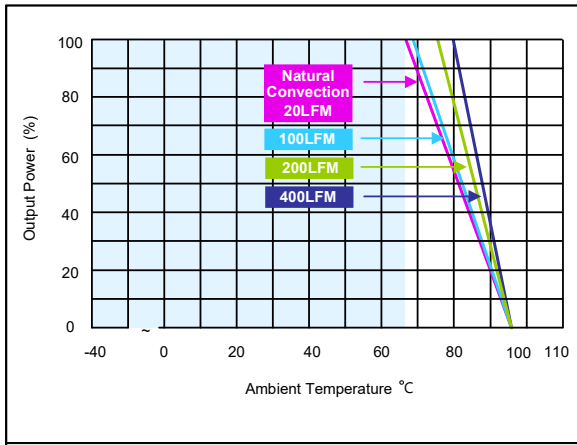

Figure 83: AEE00CC48-M Derating Curves (without heatsink)
 Vin = 48Vdc Load: Io = 0 to ±0.333A

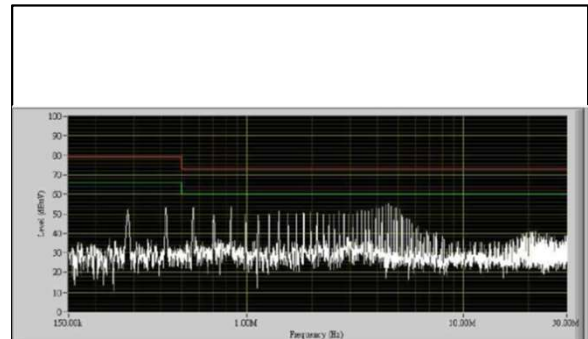
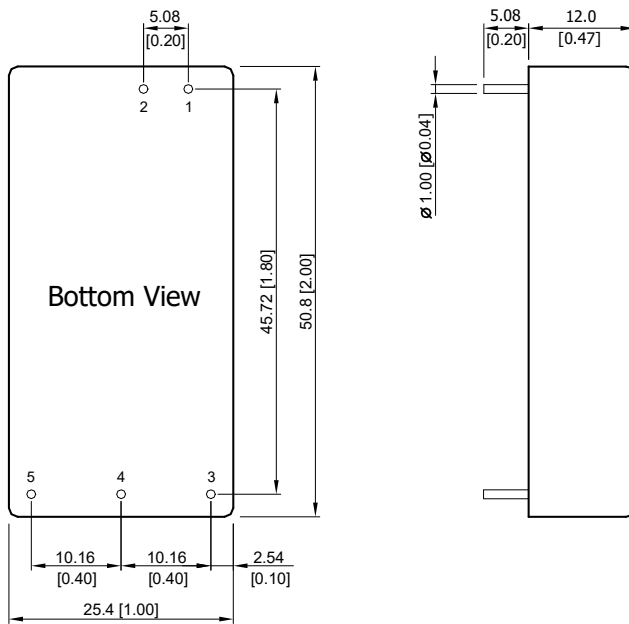

Figure 84: AEE00CC48-M Conduction Emission of EN550122 Class A
 Vin = 48Vdc Load: Io = ±0.333A

Note - All test conditions are at 25 °C

Mechanical Specifications

Mechanical Outlines (unit: mm)



Note:

- 1.All dimensions in mm (inches)
- 2.Tolerance: X.X±0.25 (X.XX±0.01)
X.XX±0.13 (X.XXX±0.005)
- 3.Pin diameter 1.0 ±0.05 (0.04±0.002)

Pin Connections

Single output

- Pin 1 - +Vin
- Pin 2 - -Vin
- Pin 3 - +Vout
- Pin 4 - No Pin
- Pin 5 - -Vout

Dual Output

- Pin 1 - +Vin
- Pin 2 - -Vin
- Pin 3 - +Vout
- Pin 4 - Common
- Pin 5 - -Vout

Mechanical Specifications

Recommended Pad Layout

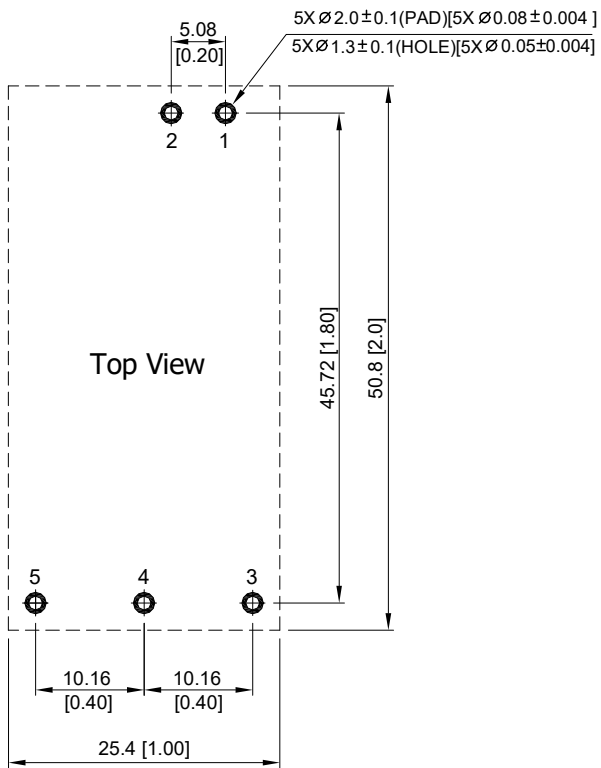

Environmental Specifications

EMC Immunity

AEE10W-M series power supply is designed to meet the following EMC immunity specifications.

Table 4. EMC Specifications		
Parameter	Standards & Level	Performance
EMI	EN55022	Class A
ESD	EN61000-4-2 air $\pm 15\text{KV}$, Contact $\pm 8\text{KV}$	Perf. Criteria A
EN 60601-1-2 4th, EN 55024		
Radiated immunity	EN61000-4-3 10V/m	Perf. Criteria A
Fast transient ¹	EN61000-4-4 $\pm 2\text{KV}$	Perf. Criteria A
Surge ¹	EN61000-4-5 $\pm 1\text{KV}$	Perf. Criteria A
Conducted immunity	EN61000-4-6 10Vrms	Perf. Criteria A

Note 1 - AEE10W-M series can meet EN61000-4-4 & EN61000-4-5 by adding a capacitor across the input pins. Suggested capacitor: CHEMI-CON KY 220uF/100V

Environmental Specifications

Safety Certifications

The AEE10W-M series power supply is intended for inclusion in other equipment and the installer must ensure that it is in compliance with all the requirements of the end application. This product is only for inclusion by professional installers within other equipment and must not be operated as a stand alone product.

Table 5. Safety Certifications for AEE10W-M series power supply system	
Document	Description
cUL/UL 60950-1 (CSA certificate)	US and Canada Requirements
IEC/EN 60950-1 (CB-scheme)	European Requirements (All CENELEC Countries)
UL60601-1	US Medical Requirements
IEC/EN 60950-1, IEC/EN 60601-1 3rd Edition, 2 MOOP	International and European Medical Requirements

Environmental Specifications

Operating Temperature

Table 6. Operating Temperature				
Parameter	Model / Condition	Min	Max	Unit
Operating Temperature Range (Natural Convection ¹ , See Derating)	All	-40	+85	°C
Operating Case Temperature	All	-	+95	°C
Thermal Protection	Shutdown Temperature	-	110	°C
Storage Temperature Range		-50	+125	°C
Humidity (non condensing)		-	95	%
Altitude		-	4000	m
Cooling	Free-Air convection			
Lead Temperature (1.5mm from case for 10Sec.)		-	260	°C

Note1 - The “natural convection” is about 20LFM but is not equal to still air (0 LFM).

Environmental Specifications

MTBF and Reliability

The MTBF of AEE10W-M series of DC/DC converters has been calculated using MIL-HDBK 217F NOTICE2, Operating Temperature 25 °C, Ground Benign.

Model	MTBF	Unit
AEE01A12-M	1040000	Hours
AEE00B12-M	1320000	
AEE00BB12-M	1140000	
AEE00CC12-M	1290000	
AEE02A24-M	1000000	
AEE00B24-M	1310000	
AEE00BB24-M	1380000	
AEE00CC24-M	1530000	
AEE02A48-M	1100000	
AEE00B48-M	1080000	
AEE00BB48-M	1050000	
AEE00CC48-M	1380000	

Application Notes

Input Reflected-Ripple Current Test Setup

Input reflected-ripple current is measured with an inductor L_{in} ($4.7\mu\text{H}$) and C_{in} ($220\mu\text{F}$, $\text{ESR} < 1.0\Omega$ at 100 KHz) to simulate source impedance. Capacitor C_{in} offsets possible battery impedance. Current ripple is measured at the input terminals of the module, measurement bandwidth is $0\text{-}500\text{ KHz}$.

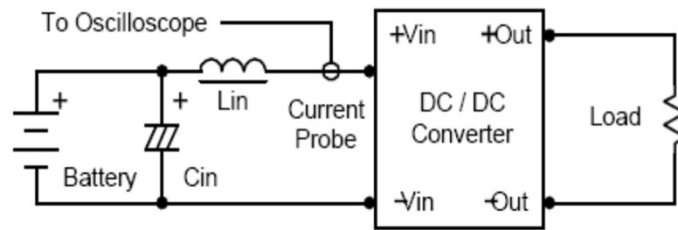

Component	Value	Reference
L_{in}	$4.7\mu\text{H}$	-
C_{in}	$220\mu\text{F}$ ($\text{ESR} < 1.0\Omega$ at 100 KHz)	Aluminum Electrolytic Capacitor

Application Notes

Output Ripple Reduction

A good quality low ESR capacitor placed as close as practicable across the load will give the best ripple and noise performance. To reduce output ripple, it is recommended to use 3.3 μ F capacitors at the output.

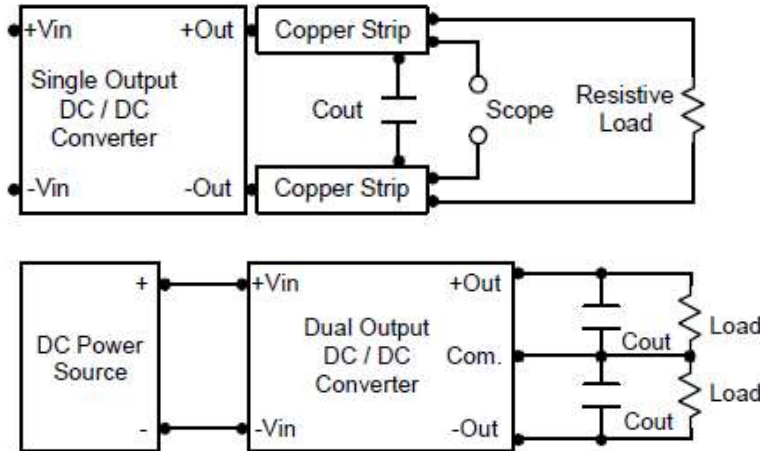

Peak-to-Peak Output Noise Measurement Test

Refer to the output specifications or add 4.7 μ F capacitor if the output specifications undefine Cout. Scope measurement should be made by using a BNC socket, measurement bandwidth is 0-20MHz. Position the load between 50 mm and 75 mm from the DC/DC Converter.

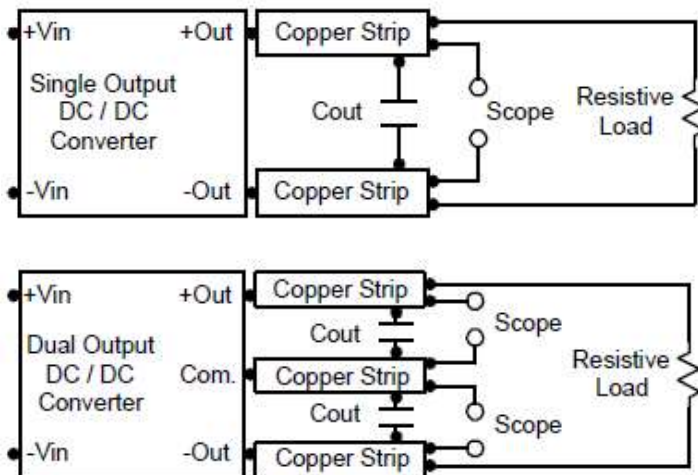

Application Notes

Input Source Impedance

The power module should be connected to a low ac-impedance input source. Highly inductive source impedances can affect the stability of the power module.

In applications where power is supplied over long lines and output loading is high, it may be necessary to use a capacitor at the input to ensure startup.

Capacitor mounted close to the power module helps ensure stability of the unit, it is recommended to use a good quality low Equivalent Series Resistance ($ESR < 1.0\Omega$ at 100 KHz) capacitor of a 10uF for the 24V and 48V devices.

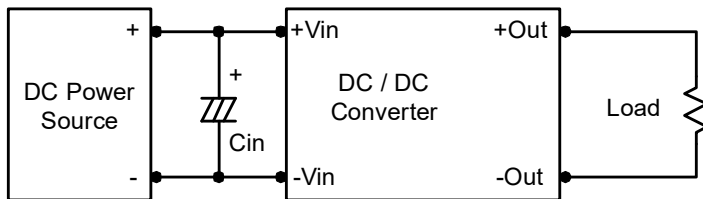

Output Over Current Protection

To provide hiccup mode protection in a fault (output overload) condition, the unit is equipped with internal current limiting circuitry and can endure overload for an unlimited duration.

Thermal Considerations

Many conditions affect the thermal performance of the power module, such as orientation, airflow over the module and board spacing. To avoid exceeding the maximum temperature rating of the components inside the power module, the case temperature must be kept below 95 °C. The derating curves are determined from measurements obtained in a test setup.

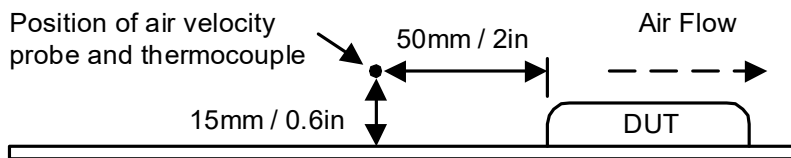

Maximum Capacitive Load

The AEE10W-M series has limitation of maximum connected capacitance at the output. The power module may be operated in current limiting mode during start-up, affecting the ramp-up and the startup time. The maximum capacitance can be found in the Table 3.

Application Notes

Packaging Information

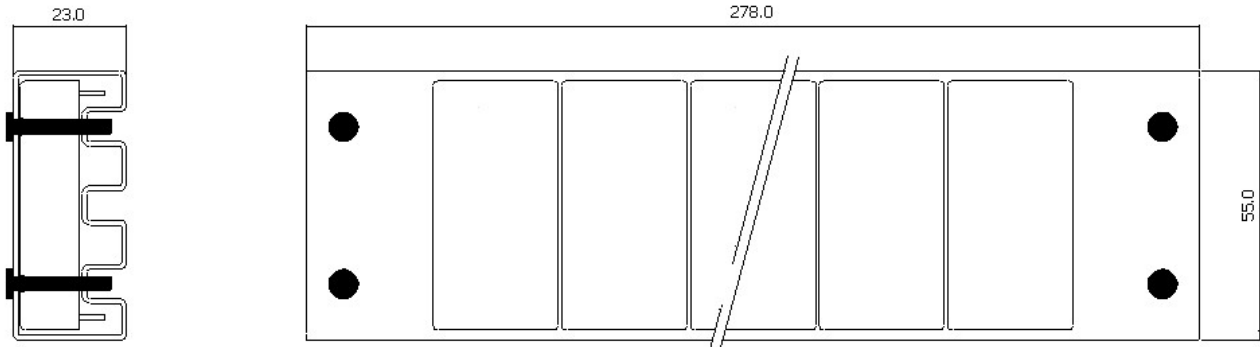

Soldering and Reflow Considerations

Lead free wave solder profile for AEE10W -M Series

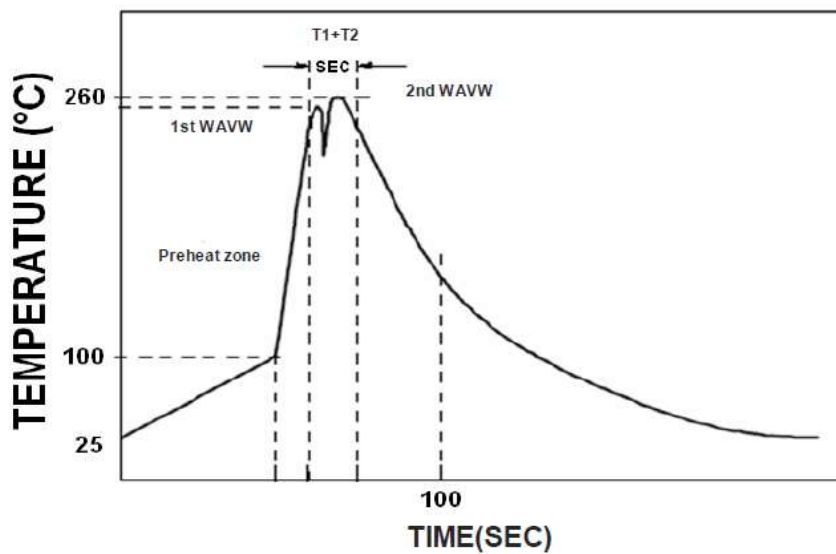

Zone	Reference Parameter
Preheat zone	Rise temp speed: 3°C/sec max.
	Preheat temp : 100~130°C
Actual heating	Peak temp: 250~260°C Peak Time
	Peak time(T1+T2): 4~6 sec

Reference Solder: Sn-Ag-Cu: Sn-Cu: Sn-Ag
 Hand Welding: Soldering iron: Power 10W
 Welding Time: 2~4 sec
 Temp.: 380~400 °C

Record of Revision and Changes

Issue	Date	Description	Originators
1.0	12.31.2014	First Issue	K. Wang
1.1	01.27.2015	Type issue	K. Wang
1.4	03.29.2017	Updated the EMC and ripple and noise part	K. Wang



For international contact information,
visit advancedenergy.com.

powersales@aei.com (Sales Support)
productsupport.ep@aei.com (Technical Support)
+1 888 412 7832

ABOUT ADVANCED ENERGY

Advanced Energy (AE) has devoted more than three decades to perfecting power for its global customers. AE designs and manufactures highly engineered, precision power conversion, measurement and control solutions for mission-critical applications and processes.

Our products enable customer innovation in complex applications for a wide range of industries including semiconductor equipment, industrial, manufacturing, telecommunications, data center computing, and medical. With deep applications know-how and responsive service and support across the globe, we build collaborative partnerships to meet rapid technological developments, propel growth for our customers, and innovate the future of power.

PRECISION | POWER | PERFORMANCE

Specifications are subject to change without notice. Not responsible for errors or omissions. ©2020 Advanced Energy Industries, Inc. All rights reserved. Advanced Energy®, and AE® are U.S. trademarks of Advanced Energy Industries, Inc.