

AVD75-48S3V3

66 Watts

Sixteenth-brick Converter

Total Power: 66 Watts
Input Voltage: 36 to 75 Vdc
of Outputs: Single

Special Features

- Delivers up to 20A output
- Ultra-high efficiency 92% typ. at full load
- Wide input range: 36V ~ 75V
- Excellent thermal performance
- No minimum load requirement
- Basic isolation
- High power density
- Low output noise
- Reflow soldering-able
- RoHS 6 compliant
- Remote control function (negative logic)
- Remote output sense
- Trim function: 90% ~ 110%
- Input under voltage lockout
- Output over current protection
- Output short protection
- Output over voltage protection
- Over temperature protection
- Industry standard sixteenth-brick pin-out outline
- SMT

Safety

EN 62368-1
UL/CSA 60950
CE Mark
EN55022
UL94, V-0 flammability rating

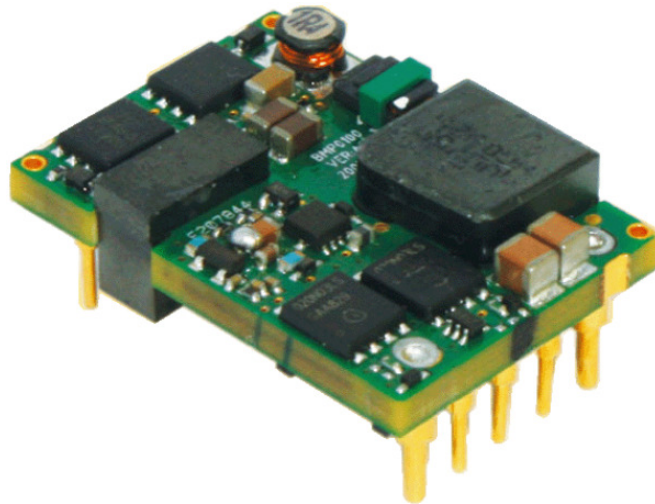

Product Descriptions

The AVD75-48S3V3 is a single output DC/DC converter with standard sixteenth-brick form factor and pin configuration. It delivers up to 20A output current with 3.3V output voltage. Ultra-high 92% efficiency and excellent thermal performance makes it an ideal choice for use in computing and telecommunication applications and can operate over an ambient temperature range of -40 °C ~ +85 °C.

Applications

Telecom/ Datacom

Model Numbers

Standard	Output Voltage	Structure	Remote ON/OFF logic	RoHS Status
AVD75-48S3V3-6L	3.3Vdc	Open frame	Negative	R6
AVD75-48S3V3-8L	3.3Vdc	Open frame	Negative	R6
AVD75-48S3V3P-6L	3.3Vdc	Open frame	Positive	R6

Ordering information

AVD75	-	48	S	3V3	P	B	-	6	L
①		②	③	④	⑤	⑥		⑦	⑧

①	Model series	AVD: high efficiency sixteenth brick series
②	Input voltage	48: 36V ~ 75V input range, rated input voltage 48V
③	Output number	S: single output
④	Rated output voltage	3V3: 3.3V output
⑤	Remote ON/OFF logic	Default: negative logic; P: positive logic
⑥	Baseplate	B: with baseplate; default: open frame
⑦	Pin length	6: 3.8mm pin length; 8: 2.8mm pin length; S: SMT pin
⑧	RoHS status	L: RoHS, R6

Options

None

Electrical Specifications

Absolute Maximum Ratings

Stress in excess of those listed in the “Absolute Maximum Ratings” may cause permanent damage to the power supply. These are stress ratings only and functional operation of the unit is not implied at these or any other conditions above those given in the operational sections of this TRN. Exposure to any absolute maximum rated condition for extended periods may adversely affect the power supply’s reliability.

Table 1. Absolute Maximum Ratings:

Parameter	Model	Symbol	Min	Typ	Max	Unit
Input Voltage Operating -Continuous Non-operating -100mS	All	$V_{IN,DC}$	-	-	80	Vdc
	All		-	-	100	Vdc
Maximum Output Power	All	$P_{O,max}$	-	-	66	W
Isolation Voltage ¹ Input to outputs	All		1500	-	-	Vdc
Ambient Operating Temperature	All	T_A	-40	-	+85	°C
Storage Temperature	All	T_{STG}	-55	-	+125	°C
Voltage at remote ON/OFF pin	All		-0.3	-	+5	Vdc
Humidity (non-condensing) Operating Non-operating	All		-	-	95	%
	All		-	-	95	%

Note 1 - Basic insulation, pollution degree 2, 1mA for 60S slew rate of 2000V/10S

Input Specifications

Table 2. Input Specifications:

Parameter	Conditions ¹	Symbol	Min	Typ	Max	Unit
Operating Input Voltage, DC	All	$V_{IN,DC}$	36	48	75	Vdc
Turn-on Voltage Threshold	$I_O = I_{O,max}$	$V_{IN,ON}$	31	-	36	Vdc
Turn-off Voltage Threshold	$I_O = I_{O,max}$	$V_{IN,OFF}$	30	-	35	Vdc
Lockout Voltage Hysteresis	$I_O = I_{O,max}$		1	-	3	V
Maximum Input Current ($I_O = I_{O,max}$)	$V_{IN,DC} = 36V_{DC}$	$I_{IN,max}$	-	-	3	A
No-load Input Current			-	0.04	-	A
Standby Input Current	Remote OFF		-	0.01	-	A
Recommended Input Fuse	Fast blow external fuse recommended; Figure 15		-	-	5	A
Input Filter Component Values (C\L)	Internal value			0\1		$\mu F \backslash \mu H$
Recommended External Input Capacitance	Low ESR capacitor recommended; Figure 15	C_{IN}	100	-	-	μF
Input Reflected Ripple Current	Through 12 μH inductor; Figure18		-	-	40	mA
Operating Efficiency	$T_A = 25^\circ C$ $I_O = I_{O,max}$ $I_O = 50\% I_{O,max}$	η	-	92 90	-	% %

Note 1 - $T_a = 25^\circ C$, airflow rate = 300 LFM, $V_{in} = 48V_{dc}$, nominal V_{out} unless otherwise noted.

Output Specifications

Table 3. Output Specifications:

Parameter	Condition ¹	Symbol	Min	Typ	Max	Unit	
Factory Set Voltage	$V_{IN,DC} = 48V_{DC}$ $I_O = 50\%I_{O,max}$	V_O	3.25	3.30	3.35	Vdc	
Total Regulation	Inclusive of line, load temperature change, life, warm-up drift	V_O	3.2	3.3	3.4	Vdc	
Output Voltage Line Regulation	All	$\%V_O$	-	-	0.2	%	
Output Voltage Load Regulation	All	$\%V_O$	-	-	0.5	%	
Output Voltage Temperature Regulation	All	$\%V_O$	-	-	0.02	$\%/^{\circ}C$	
Output Voltage Trim Range	All	V_O	2.64	-	3.63	V	
Output Ripple, pk-pk	Measure with a 1uF ceramic capacitor in parallel with a 10uF tantalum capacitor, 0 to 20MHz bandwidth	V_O	-	85	120	mV _{PK-PK}	
Output Current	All	I_O	0	-	20	A	
Output DC current-limit inception ²		I_O	26	-	35	A	
V_O Load Capacitance ³	All	C_O	220	470	10000	uF	
V_O Dynamic Response	Peak Deviation Settling Time	50%~75%~50% 25% load change slew rate = 0.1A/us	$\pm V_O$	-	55	-	mV
		50%~75%~50% 25% load change slew rate = 1A/us	T_s	-	100	-	uSec
Turn-on transient	Rise time	$I_O = I_{max}$	T_{rise}	-	-	50	mS
	Turn-on delay time	$I_O = I_{max}$	$T_{turn-on}$	-	-	100	mS
	Output voltage overshoot	$I_O = 0$	$\%V_O$	-	-	5	%
Switching frequency	All	f_{SW}	230	240	250	KHz	

Note 1 - $T_a = 25^{\circ}C$, airflow rate = 300 LFM, $V_{in} = 48V_{dc}$, nominal V_{out} unless otherwise noted.

Note 2 - Hiccup: auto-restart when over-current condition is removed.

Note 3 - High frequency and low ESR is recommended.

Output Specifications

Table 3. Output Specifications, con't:

Parameter		Condition	Symbol	Min	Typ	Max	Unit
Remote ON/OFF control (positive logic)	Off-state voltage	All		-0.3	-	1.2	V
	On-state voltage	All		3.5	-	5	V
Remote ON/OFF control (Negative logic)	Off-state voltage	All		3.5	-	5	V
	On-state voltage	All		-0.3	-	1.2	V
Output over-voltage protection ⁴		All	%V _O	120	-	160	%
Output over-temperature protection ⁵		All	T	110	125	135	°C
Over-temperature hysteresis		All	T	-	10	-	°C
MTBF		Telcordia SR-332-2006; 80% load, 300LFM, 40 °C T _A		2.0	-	-	10 ⁶ h

Note 4 - Hiccup: auto-restart when over-voltage condition is removed.

Note 5 - Auto recovery.

AVD75-48S3V3 Performance Curves

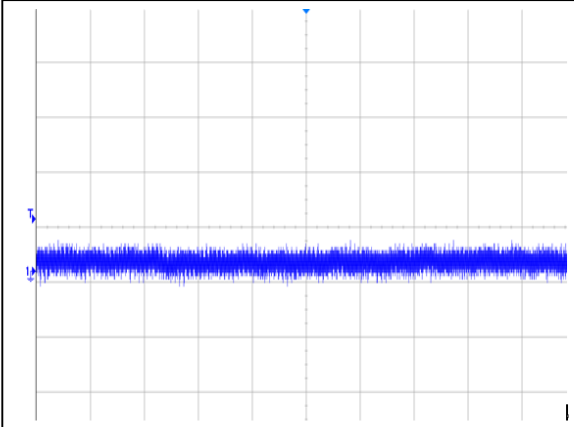

Figure 1: AVD75-48S3V3 Input Reflected Ripple Current Waveform
 Ch 1: Iin (50uS/div, 50mA/div)

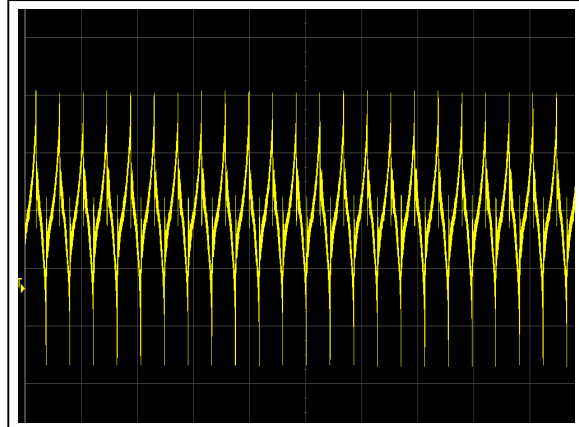

Figure 2: AVD75-48S3V3 Ripple and Noise Measurement
 Ch 1: Vo (5us/div, 20mV/div)

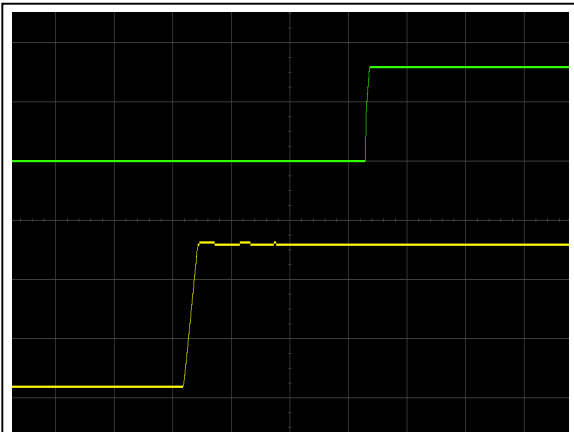

Figure 3: AVD75-48S3V3 Output Voltage Startup Characteristic (20mS/div)
 Ch 1: Vin (20V/div) Ch 2: Vout (2V/div)

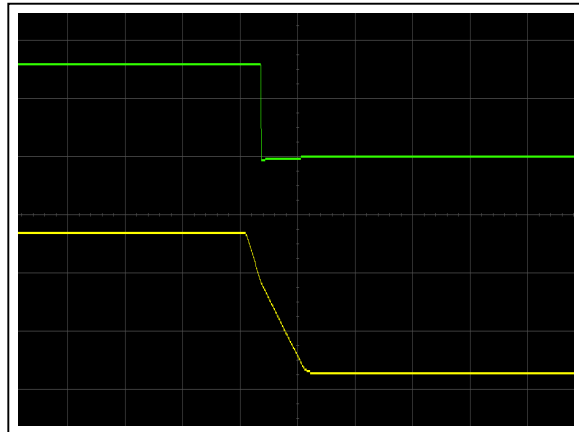

Figure 4: AVD75-48S3V3 Turn Off Characteristic (100mS/div)
 Ch 1: Vin (20V/div) Ch 2: Vout (2V/div)

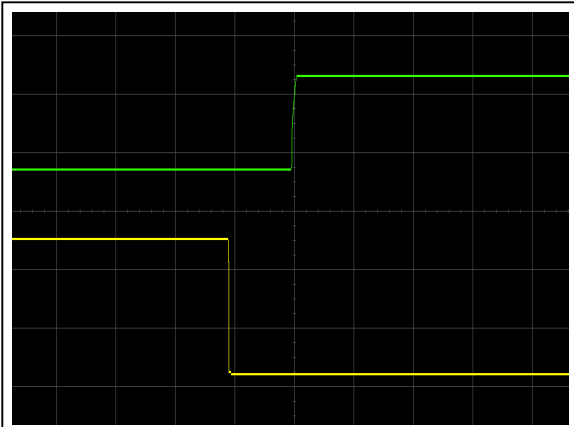

Figure 5: AVD75-48S3V3 Remote ON Waveform (50mS/div)
 Vin = 48Vdc Load: Iout = 20A
 Ch 1: Remote ON (2V/div) Ch 2: Vout (2V/div)

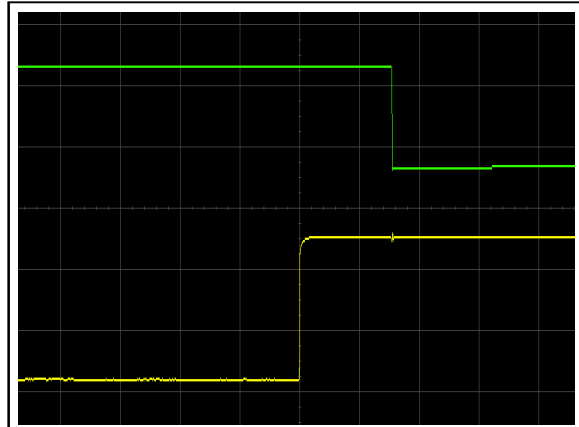

Figure 6: AVD75-48S3V3 Remote OFF Waveform (10mS/div)
 Vin = 48Vdc Load: Iout = 20A
 Ch 1: Remote OFF (2V/div) Ch 2: Vout (2V/div)

AVD75-48S3V3 Performance Curves

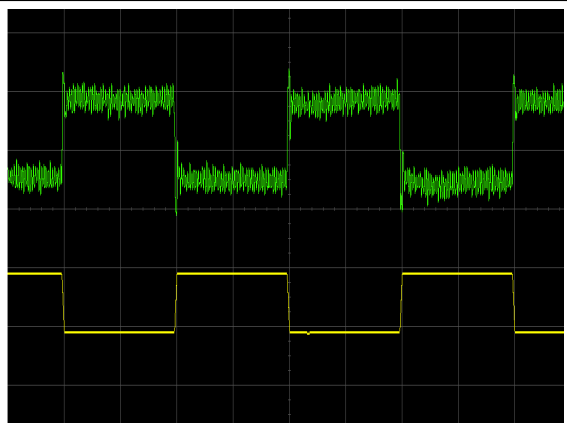

Figure 7: AVD75-48S3V3 Transient Response (1mS/div)
 50%-75%-50% load change, 0.1A/uS slew rate,
 Ch 1: Iout (5A/div) Ch 2: Vout (10mV/div)

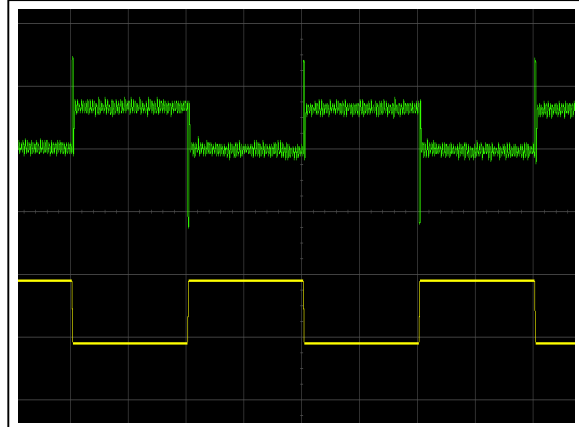

Figure 8: AVD75-48S3V3 Transient Response (1mS/div)
 50%-75%-50% load change, 1A/uS slew rate,
 Ch 1: Iout (5A/div) Ch 2: Vout (20mV/div)

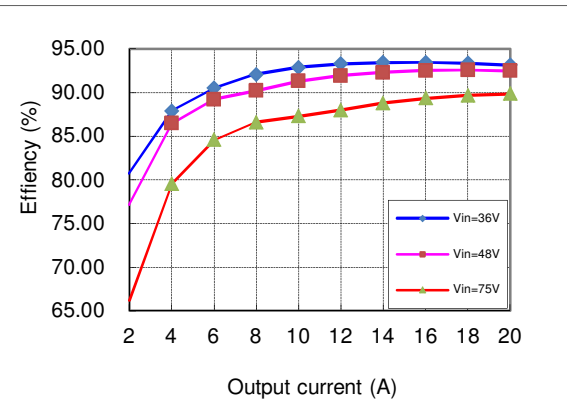
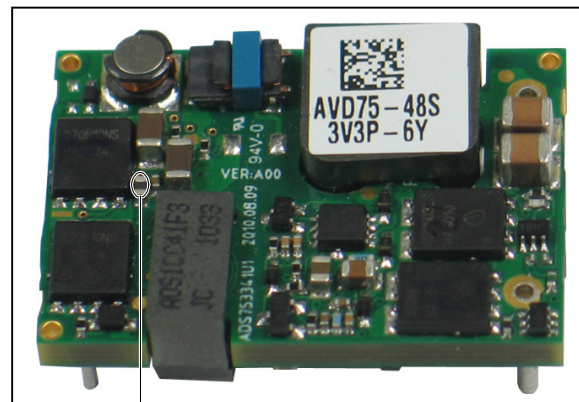

Figure 9: AVD75-48S3V3 Efficiency Curves @ 25 degC

Loading: I_o = 10% increment to 20A Air velocity=200LFM



Test point

Figure 10: OTP test point

Mechanical Specifications

Mechanical Outlines – Open Frame Module

AVD75-48S3V3

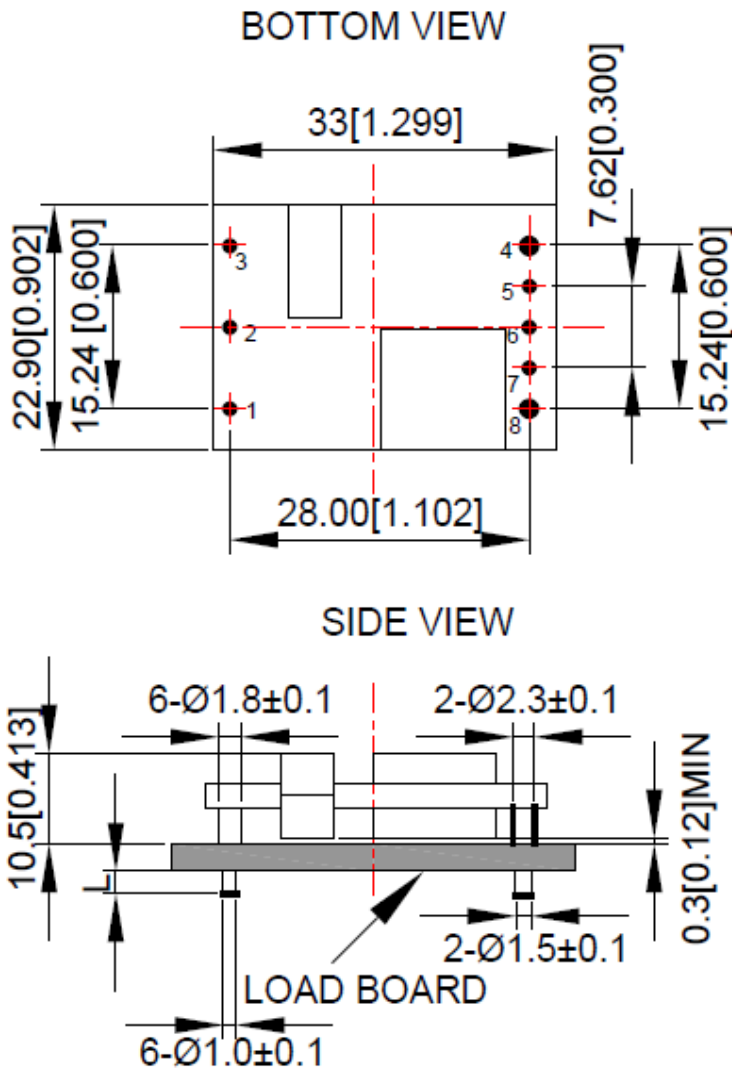

UNIT: mm[inch]

BOTTOM VIEW: pin on upside

TOLERANCE: X.Xmm±0.5mm[X.XX in.±0.02in.]

X.XXmm±0.25mm[X.XXX in.±0.01in.]

Pin Length Option

Device code suffix	L
-4	4.8mm ±0.2 mm
-6	3.8mm ±0.2 mm
-8	2.8mm ±0.2 mm
None	5.8mm ±0.2 mm

Pin Designations

Pin No	Name	Function
1	Vin+	Positive input voltage
2	Remote On/Off	Remote control
3	Vin-	Negative input voltage
4	Vo-	Negative output voltage
5	S-	Negative remote sense
6	Trim	Output voltage trim
7	S+	Positive remote sense
8	Vo+	Positive output voltage

Environmental Specifications

EMC Immunity

AVD75-48S3V3 power supply is designed to meet the following EMC immunity specifications:

Table 4. Environmental Specifications:

Document	Description	Criteria
EN55022, Class A Limits	Conducted and Radiated EMI Limits	
IEC/EN 61000-4-2, Level 3	Electromagnetic Compatibility (EMC) - Testing and measurement techniques - Electrostatic discharge immunity test. Enclosure Port	B
IEC/EN 61000-4-4, Level 3	Electromagnetic Compatibility (EMC) - Testing and measurement techniques, Electrical Fast Transient. DC input port.	B
IEC/EN 61000-4-5, Level 3	Electromagnetic Compatibility (EMC) - Testing and measurement techniques, Immunity to surges - 600V common mode and 600V differential mode for DC ports	B
IEC/EN 61000-4-6, Level 2	Electromagnetic Compatibility (EMC) - Testing and measurement techniques, Continuous Conducted Interference. DC input port	A
EN61000-4-29	Electromagnetic Compatibility (EMC) - Testing and measurement techniques, Voltage Dips and short interruptions and voltage variations. DC input port	B

Criterion A: Normal performance during and after test.

Criterion B: For EFT and surges, low-voltage protection or reset is not allowed. Temporary output voltage fluctuation ceases after disturbances ceases, and from which the EUT recovers its normal performance automatically.

For Dips and ESD, output voltage fluctuation or reset is allowed during the test, but recovers to its normal performance automatically after the disturbance ceases.

Criterion C: Temporary loss of output, the correction of which requires operator intervention.

Criterion D: Loss of output which is not recoverable, owing to damage to hardware.

EMC Test Conditions

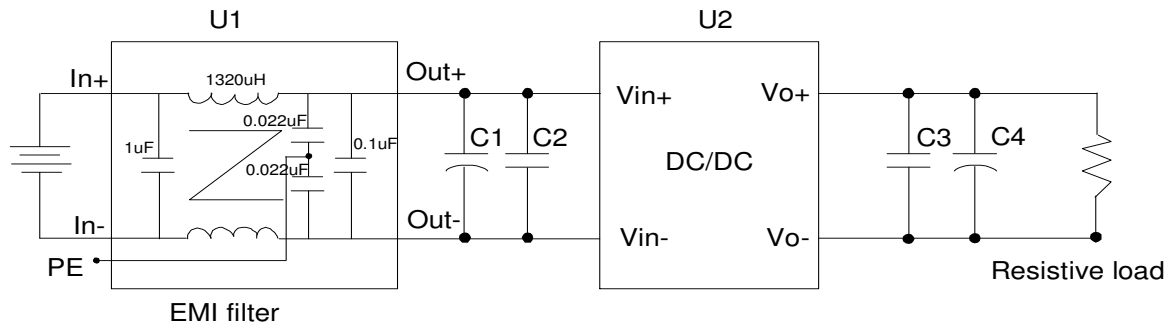

Figure 12 EMC test configuration

U1: Input EMC filter

U2: Module to test, AVD75-48S3V3

C1 ~ C4: See Figure 15

Safety Certifications

The AVD75-48S3V3 power supply is intended for inclusion in other equipment and the installer must ensure that it is in compliance with all the requirements of the end application. This product is only for inclusion by professional installers within other equipment and must not be operated as a stand alone product.

Table 5. Safety Certifications for AVD75-48S3V3 power supply system

Document	File #	Description
UL/CSA 60950-1		US and Canada Requirements
EN62368-1		European Requirements
CE		CE Marking

Operating Temperature

The AVD75-48S3V3 power supplies will start and operate within stated specifications at an ambient temperature from -40 °C to 85 °C under all load conditions. The storage temperature is -55 °C to 125 °C.

Thermal Considerations – Open-frame module

The converter is designed to operate in different thermal environments and sufficient cooling must be provided. Proper cooling of the DC/DC converter can be verified by measuring the temperature at the test point as shown in the Figure 13. The temperature at this point should not exceed the max values in the table 6.

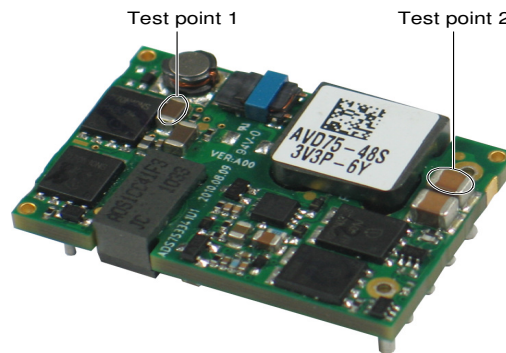

Figure 13 Temperature test point

Table 6. Temperature limit of the test point

Test Point	Temperature Limit
Test point 1	118 °C
Test point 2	118 °C

For a typical application, figure 14 shows the derating of output current vs. ambient air temperature at different air velocity.

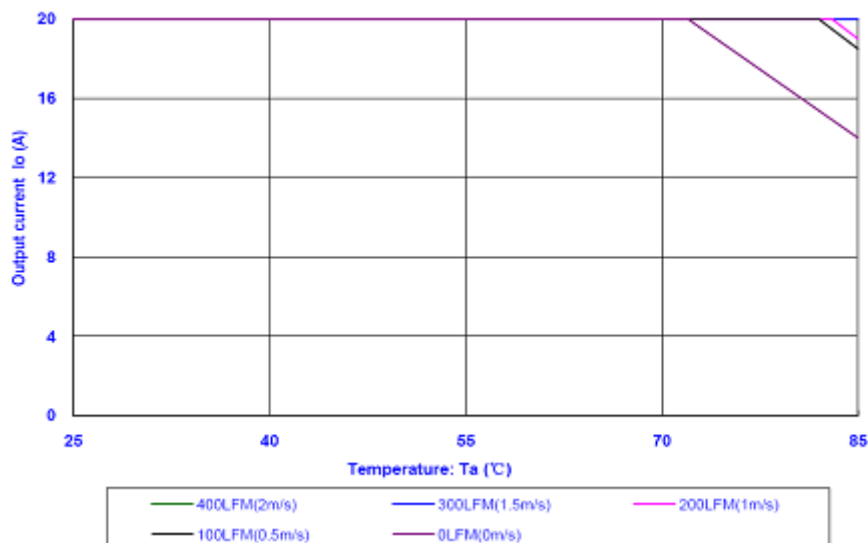

Figure 14 Output power derating, 48Vin, air flowing across the converter from pin 3 to pin 1

Qualification Testing

Parameter	Unit (pcs)	Test condition
Halt test	4-5	-75 °C to +125°C, 10 °C step, Vin = min to max, 0 ~ 105% load
Vibration	3	Frequency range: 5Hz ~ 20Hz, 20Hz ~ 200Hz, A.S.D: 1.0m ² /s ³ , -3db/oct, axes of vibration: X/Y/Z, Time: 30min/axes
Mechanical Shock	3	Acceleration: 300m/s ² , Duration: 6ms, Axes: X,Y,Z 6 directions Times: 3 in each direction
Thermal Shock	3	High Temp: 125 °C, Low Temp: -55 °C Temp Dwell Time:30min, Temp change time:<10S, Cycles:20cycles
Thermal Cycling	3	High Temp: 85 °C, Low Temp: -40 °C Temp Dwell Time:30min, Temp change rate:1 °C /min, Cycles:2cycles
Humidity	3	40 °C, 95%RH, 48h
Solder Ability	15	IPC J-STD-002C-2007

Application Notes

Typical Application

Below is the typical application of the AVD75-48S3V3 power supply.

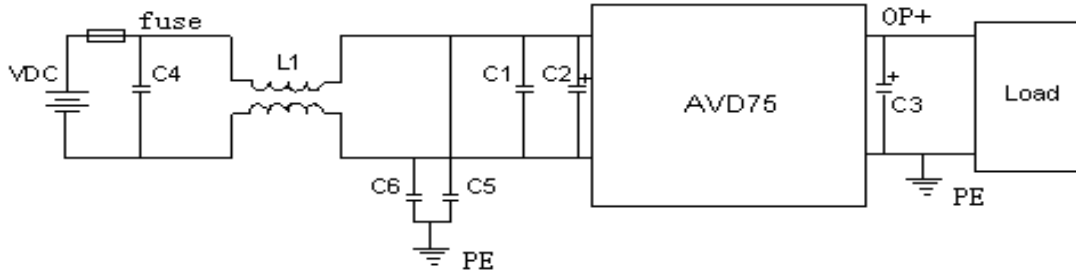

Figure 15 Typical application

C1: 100 μ F/100V electrolytic capacitor; P/N: UPW2A101MHD (Nichicon) or equivalent caps

C2, C3: 1 μ F/100V X7R ceramic capacitor, P/N: C3225X7R2A105KT0L0U (TDK) or equivalent caps

C4: 470 μ F electrolytic capacitor, P/N: UPM1A471MHD (Nichicon) or equivalent caps

Fuse: External fast blow fuse with a rating of 5A. The recommended fuse model is 216005.P from LITTLEFUSE.

Remote ON/OFF

Negative remote ON/OFF logic is available in AVD75-48S3V3. The logic is CMOS and TTL compatible. The voltage between pin Remote ON/OFF and pin Vin- must not exceed the range listed in table “Feature characteristics” to ensure proper operation. The external Remote ON/OFF circuit is highly recommended as shown in figure 15.

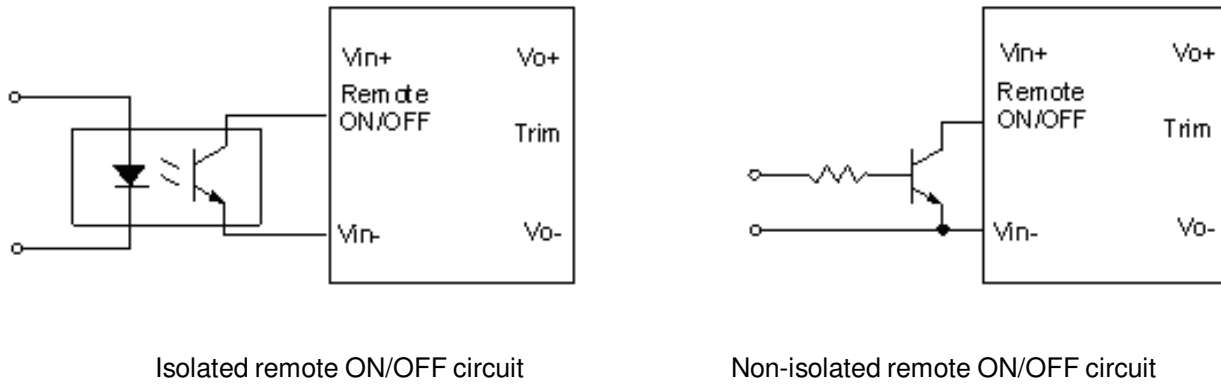

Figure 16 External Remote ON/OFF circuit

Trim Characteristics

Connecting an external resistor between Trim pin and Vo- pin will decrease the output voltage. While connecting it between Trim and Vo+ will increase the output voltage. The following equations determine the external resistance to obtain the trimmed output voltage.

$$R_{adj-down} = \frac{510}{\Delta} - 10.2(K\Omega)$$

$$R_{adj-up} = \frac{5.1 \times V_{nom} \times (100 + \Delta)}{1.225 \times \Delta} - \frac{510}{\Delta} - 10.2(K\Omega)$$

Δ : Output error rate against nominal output voltage.

$$\Delta = \frac{100 \times (V_{nom} - V_0)}{V_{nom}}$$

V_{nom} : Nominal output voltage.

For example, to get 3.63V output, the trimming resistor is

$$\Delta = \frac{100 \times (V_{nom} - V_0)}{V_{nom}} = \frac{100 \times (3.63 - 3.3)}{3.3} = 10$$

$$R_{adj-up} = \frac{5.1 \times 3.3 \times (100 + 10)}{1.225 \times 10} - \frac{510}{10} - 10.2 = 89.9(K\Omega)$$

When trimming up, the output current should be decreased accordingly so as not to exceed the maximum output power and the minimum input voltage should be increased as shown in below figure.

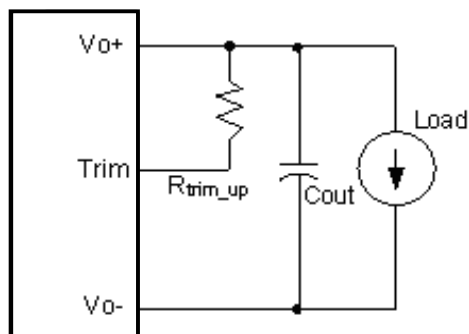

Figure 17 Trim up

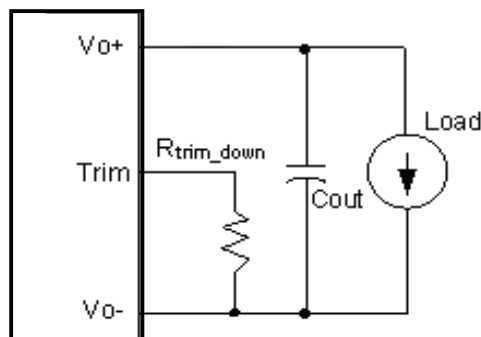

Figure 18 Trim down

Input Ripple & Output Ripple & Noise Test Configuration

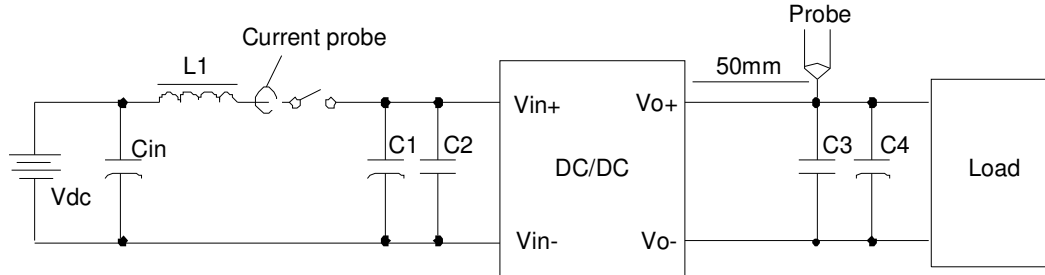

Figure 19 Input ripple & output ripple & noise test configuration

Vdc: DC power supply

L1: 12 μ H

Cin: 220 μ F/100V typical

C1 ~ C4: See Figure 15

Note: Using a coaxial cable with series 50 Ω resistor and 0.68 μ F ceramic capacitor or a ground ring of probe to test output ripple & noise is recommended.

Weight

The AVD75-48S3V3 weight is 31.5g maximum.

Application Notes

Soldering

The product is intended for standard manual or wave soldering.

	Product Requirement	Product Name
R6	Wave soldering	AVD75-48S3V3-6L AVD75-48S3V3-8L AVD75-48S3V3P-6L

When wave soldering is used, the temperature on pins is specified to maximum 260 °C for maximum 7s.

When soldering by hand, the iron temperature should be maintained at 300 °C ~ 380 °C and applied to the converter pins for less than 10s. Longer exposure can cause internal damage to the converter. Cleaning of solder joint can be performed with cleaning solvent IPA or simulative.

The below product is intended for standard reflow soldering.

	Product Requirement	Product Name
R6	Reflow soldering	AVD75-48S3V3-6L AVD75-48S3V3-8L AVD75-48S3V3P-6L

When reflow soldering is used, the temperature on pins is specified to maximum 240 °C for maximum 10s.

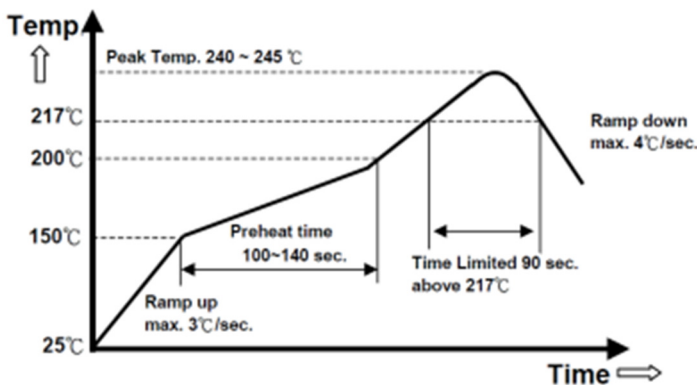

Hazardous Substances Announcement (RoHS of China R6)

Parts	Hazardous Substances					
	Pb	Hg	Cd	Cr ⁶⁺	PBB	PBDE
AVD75-48S3V3	x	x	x	x	x	x

x: Means the content of the hazardous substances in all the average quality materials of the part is within the limits specified in SJ/T-11363-2006

√: Means the content of the hazardous substances in at least one of the average quality materials of the part is outside the limits specified in SJ/T11363-2006

Artesyn Embedded Technologies has been committed to the design and manufacturing of environment-friendly products. It will reduce and eventually eliminate the hazardous substances in the products through unremitting efforts in research. However, limited by the current technical level, the following parts still contain hazardous substances due to the lack of reliable substitute or mature solution:

1. Solders (including high-temperature solder in parts) contain plumbum.
2. Glass of electric parts contains plumbum.
3. Copper alloy of pins contains plumbum

Record of Revision and Changes

Issue	Date	Description	Originators
1.0	08.24.2014	First Issue	K. Zou
1.1	08.22.2016	Update “Model Numbers”, “Efficiency Curves”, “ Thermal Dreating Curve”, “Qualification Testing” Add part number “AVD75-48S3V3-8L” Update the picture	K. Zou K. Wang
1.2	10.25.2016	Update the mechanical drawing	K. Wang
1.3	12.13.2019	Update soldering information	K. Zou
1.4	06.19.2020	Update EN60950 to EN62368-1	K. Zou

WORLDWIDE OFFICES

Americas

2900 South Diablo Way
 Suite B100
 Tempe, AZ 85282
 USA
 +1 888 412 7832

Europe (UK)

Ground Floor Offices
 Barberrry House, 4 Harbour Buildings
 Waterfront West, Brierley Hill
 West Midlands, DY5 1LN, UK
 +44 (0) 1384 842 211

Asia (HK)

14/F, Lu Plaza
 2 Wing Yip Street
 Kwun Tong, Kowloon
 Hong Kong
 +852 2176 3333



For more information: www.artesyn.com
 For support: productsupport.ep@artesyn.com